

**LOCAL AREA
TRANSPORTATION REVIEW**

FOR

15585 & 15595 OLD COLUMBIA PIKE

**Exhibit 16
S-847-B Major Modification**

Prepared by:

LENHART TRAFFIC CONSULTING, INC.

TRAFFIC ENGINEERING & TRANSPORTATION PLANNING

October 2, 2023



Table of Contents		Page
Section 1	Introduction & Scope of Work.....	4
	1.1 Project Description	
	1.2 Scope of Study	
Section 2	Motor Vehicle System Adequacy Test.....	9
	2.1 Adequacy Requirements & Study Area	
	2.2 Existing Conditions	
	2.3 Background Conditions	
	2.4 Total Conditions	
	2.5 Results of Analysis	
Section 3	Pedestrian System Adequacy.....	24
	3.1 Adequacy Requirements & Study Area	
	3.2 Pedestrian Level of Comfort (PLOC)	
	3.3 Street Lighting	
	3.4 ADA Compliance	
	3.5 Pedestrian System Adequacy Evaluation	
Section 4	Bicycle System Adequacy.....	34
	4.1 Adequacy Requirements & Study Area	
	4.2 Bicycle Level of Stress	
	4.3 Bicycle Master Plan	
	4.4 Bicycle System Adequacy Analysis & Discussion	
Section 5	Bus Transit System Adequacy.....	40
	5.1 Adequacy Requirements & Study Area	
	5.2 Bus Transit System Inventory	
	5.3 Bus Transit System Recommendations	
Section 6	Vision Zero Statement.....	42
	6.1 Overview	
	6.2 Safety Issues	
	6.3 Speed Studies	
Section 7	Conclusions.....	48

Appendices

- A Supplemental Info, Turning Movement Counts
- B Level of Service (LOS) Worksheets
- C Background Developments
- D Traffic Signal Warrant Analysis
- E Streetlight Verification
- F Speed Studies

List of Exhibits		Page
Exhibit 1a	Site Location Map	5
Exhibit 1b	Growth and Infrastructure Policy Area Map	6
Exhibit 1c	Transportation Policy Area Map	7
Exhibit 2	Trip Generation for Site	8
Exhibit 3	Lane Use & Traffic Control Devices	13
Exhibit 4	Existing Peak Hour Volumes	14
Exhibit 5	Background Peak Hour Volumes	15
Exhibit 6	Trip Generation for Site	16
Exhibit 7	Proposed Lane Use & Traffic Control Devices	17
Exhibit 8a-b	Trip Assignments for Site	18-19
Exhibit 9	Total Peak Hour Volumes	20
Exhibit 10a-b	Results of Level of Service Analyses	21-22
Exhibit 11	SimTraffic Queuing Results	23
Exhibit 12	Pedestrian Evaluation Area: PLOC	27
Exhibit 13	PLOC Index	28
Exhibit 14a-d	Pedestrian Level of Comfort Evaluation	29-32
Exhibit 15	Pedestrian Evaluation Area: ADA	33
Exhibit 16	Bicycle Evaluation Area	36
Exhibit 17	Montgomery County Bicycle Master Plan Map	37
Exhibit 18	Bicycle Level of Stress Map	38
Exhibit 19	Bicycle Infrastructure Analysis	39
Exhibit 20	Bus Transit System Evaluation	41
Exhibit 21	Site Vicinity Crash Data	44

Section 1 Introduction & Scope of Work

Section 1.1 – Project Description

This Local Area Transportation Review (LATR) is being prepared for the proposed redevelopment of property located at 15585 & 15595 Old Columbia Pike in Burtonsville, MD. The property is currently developed with a 8,100 square foot furniture store and 2,496 square foot convenience store with four fuel dispensers, each with two fueling positions. The property is proposed to be redeveloped with a 5,919 square foot convenience store with six fuel dispensers, each with 2 fueling positions.

The site is located within the Burtonsville Town Center Policy Area as shown on **Exhibits 1a-1c**. This Area is designated as an Orange Policy Area per the current 2020 – 2024 Growth and Infrastructure Policy.

As shown on the trip generation analysis provided on **Exhibit 2**, the redevelopment of the site will result in an increase of more than 50 peak hour person trips and therefore the development is subject to the LATR system adequacy tests.

The site is accessed along MD 198, with a full movement access point directly opposite the driveway for the Burtonsville Town Square shopping center, and a right-in/right-out access just east of the full movement access. Access to the site is proposed to remain as existing with the redevelopment of the site.

The June 2023 LATR Guidelines update provides a proportionality guide to ensure that off-site transportation system requirements are not out of proportion with a project’s impact on the overall safety and functionality of the transportation system. Based on the LATR Proportionality Guide Rates and Adjustment Factors, a maximum cost of improvements of \$29,151 should be established for this development.

Section 1.2 – Scope of Study

The study was conducted to satisfy LATR requirements in accordance with the Maryland-National Capital Park and Planning Commission’s (M-NCPPC) 2020 – 2024 Growth and Infrastructure Policy (GIP). Per the GIP guidelines, the following adequacy tests are required for the site: Motor Vehicle System, Pedestrian System, Bicycle System, and Bus Transit System. In addition, a Vision Zero Statement must be provided. The scope of this study was established in coordination with M-NCPPC and all relevant scoping documentation is provided in Appendix A.

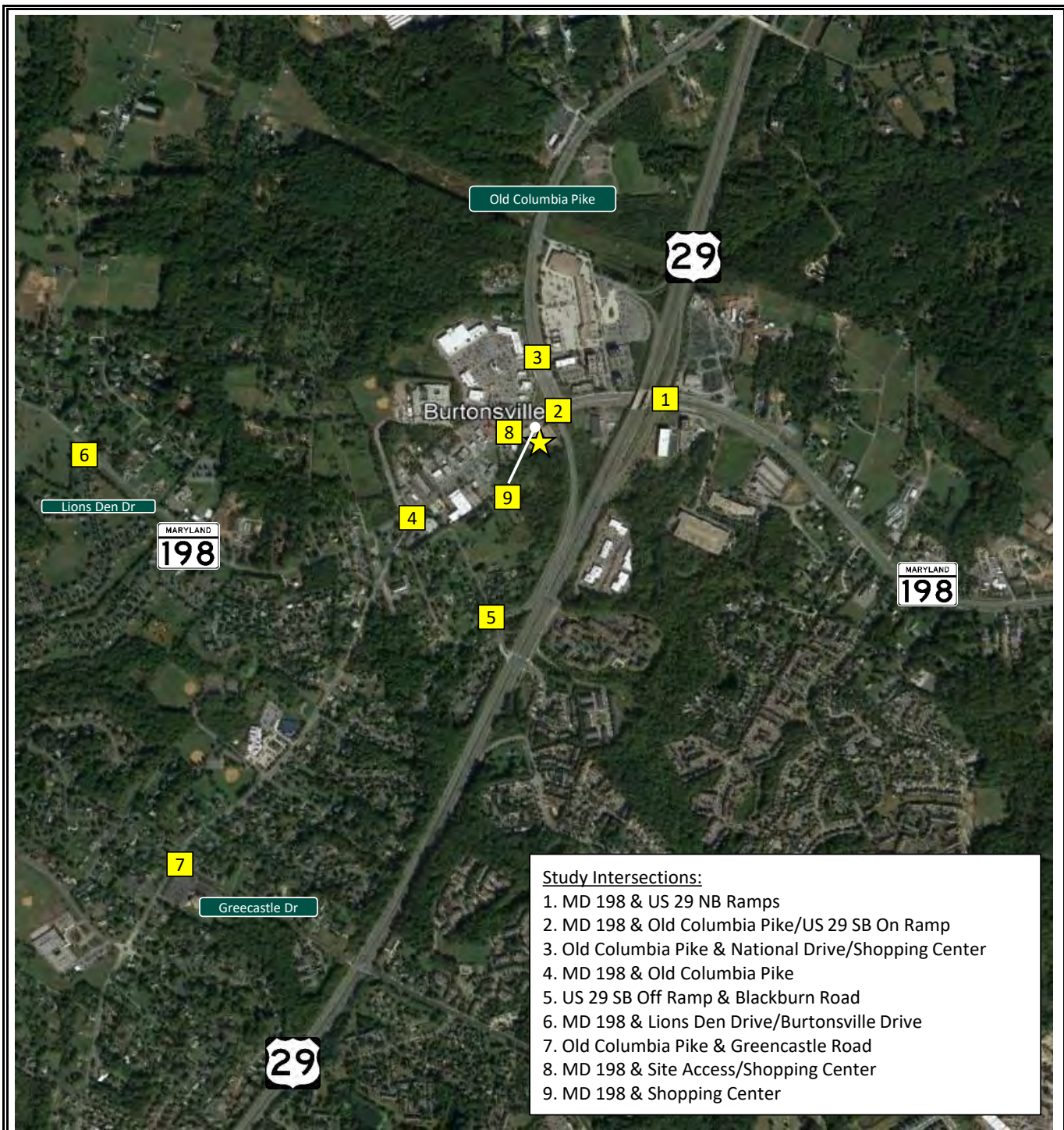

- Study Intersections:**
1. MD 198 & US 29 NB Ramps
 2. MD 198 & Old Columbia Pike/US 29 SB On Ramp
 3. Old Columbia Pike & National Drive/Shopping Center
 4. MD 198 & Old Columbia Pike
 5. US 29 SB Off Ramp & Blackburn Road
 6. MD 198 & Lions Den Drive/Burtonsville Drive
 7. Old Columbia Pike & Greencastle Road
 8. MD 198 & Site Access/Shopping Center
 9. MD 198 & Shopping Center

Transportation Facilities Analysis	Site Location Map	Exhibit 1a
Lenhart Traffic Consulting, Inc. Traffic Engineering & Transportation Planning		

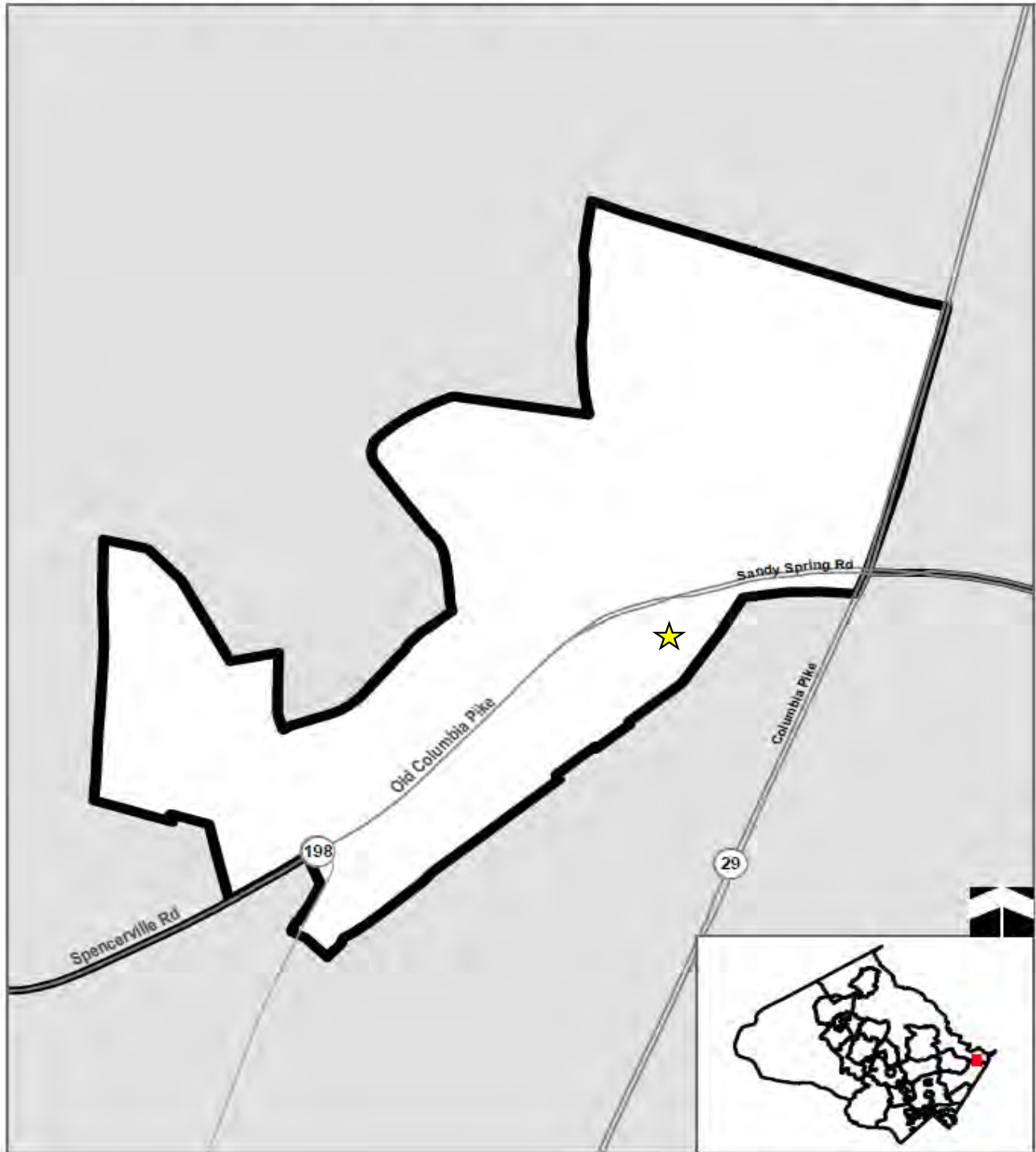

Transportation Facilities Analysis

Lenhart Traffic Consulting, Inc.
Traffic Engineering & Transportation Planning

Growth and Infrastructure
Policy Area Map

★ - Site Location

Exhibit
1b

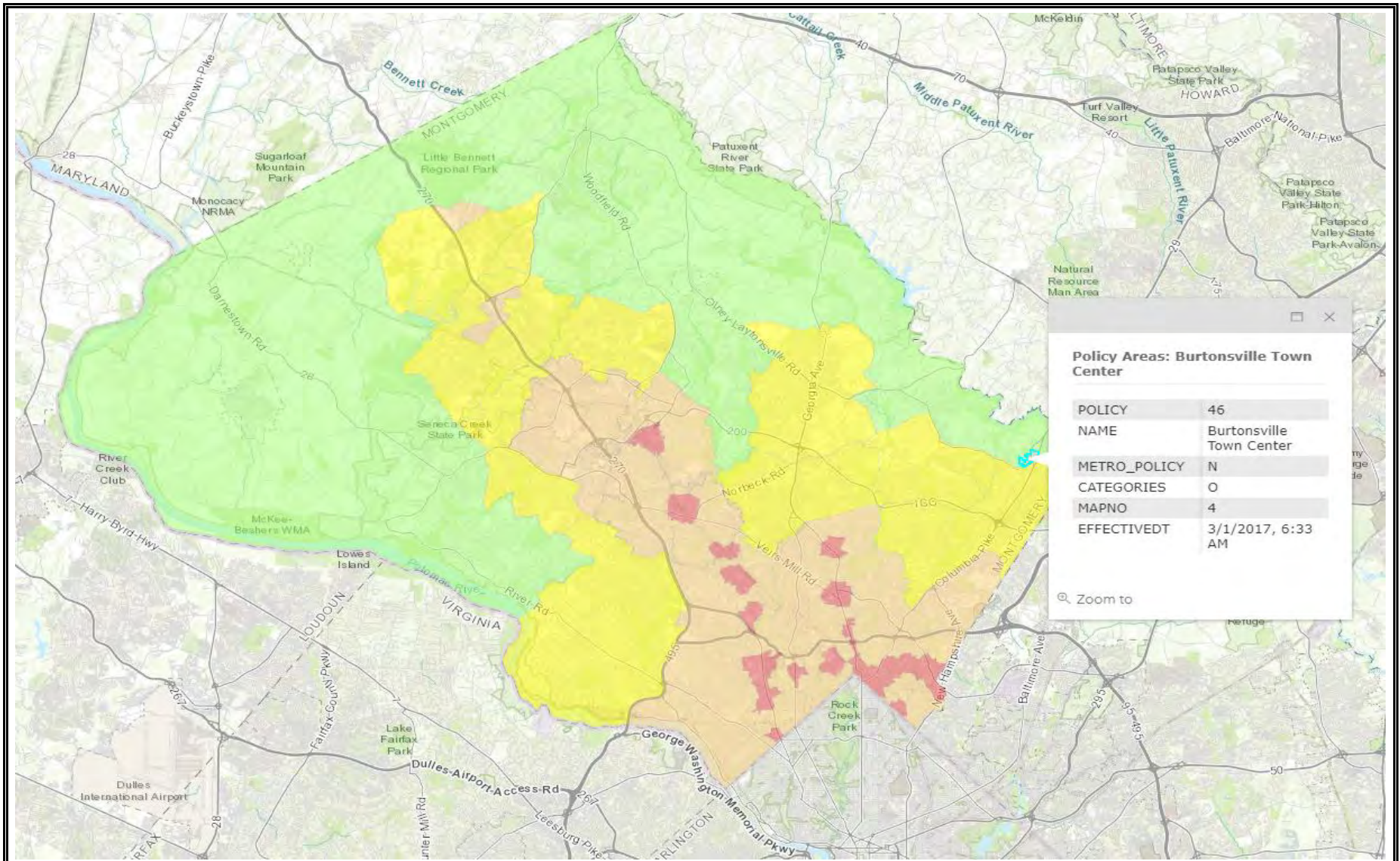

Transportation Facilities Analysis

Lenhart Traffic Consulting, Inc.

Traffic Engineering & Transportation Planning

Transportation Policy Area Map

Exhibit 1c

Trip Generation Rates

Convenience Store / Gas Station w/GFA from 5.5-10 ksf (VFP, ITE-945)

Morning Trips = 31.60 x Fueling Positions
 Evening Trips = 26.90 x Fueling Positions

Trip Distribution (In/Out)

50/50
 50/50

Furniture Store (ksf, ITE-890)

Morning Trips = 0.24 x ksf + 0.94
 Ln(Evening Trips) = 0.85 x Ln(ksf) - 0.18

Trip Distribution (In/Out)

71/29
 47/53

Convenience Store / Gas Station w/GFA from 2-4 ksf (VFP, ITE-945)

Morning Trips = 16.06 x Fueling Positions
 Evening Trips = 18.42 x Fueling Positions

Trip Distribution (In/Out)

50/50
 50/50

Trip Generation Totals

			AM Peak			PM Peak		
			In	Out	Total	In	Out	Total
Proposed	Convenience Store / Gas Station w/GFA from 5.5-10 ksf (VFP, ITE-945)	12 Fueling Positions	189	190	379	161	162	323
		<i>Pass-by Percentage (76% AM / 75% PM):</i>	-144	-144	-288	-120	-122	-242
	Proposed Vehicular Trips per ITE Trip Generation Manual, 11th Edition:		189	190	379	161	162	323
	LATR Vehicle Trip Generation Rate Adjustment Factor (Burtonsville Town Center):		99%					
	Total LATR Adjusted Vehicular Trips per ITE Trip Generation Manual, 11th Edition (Auto Driver at 71.6%):		187	188	375	160	160	320
	Total Person Trips:		261	263	524	224	223	447
	Auto Driver:	71.6%	187	188	375	160	160	320
	Auto Passenger:	24.3%	63	64	127	55	54	109
	Transit:	1.0%	2	3	5	2	2	4
	Non-Motorized:	3.1%	9	8	17	7	7	14

			AM Peak			PM Peak		
			In	Out	Total	In	Out	Total
Existing	Furniture Store (ksf, ITE-890)	8,100 sq.ft.	2	1	3	2	3	5
	Convenience Store / Gas Station w/GFA from 2-4 ksf (VFP, ITE-945)	8 Fueling Positions	64	64	128	73	74	147
		<i>Pass-by Percentage (60% AM / 56% PM):</i>	-39	-38	-77	-41	-41	-82
	Existing Vehicular Trips per ITE Trip Generation Manual, 11th Edition:		66	65	131	75	77	152
	LATR Vehicle Trip Generation Rate Adjustment Factor (Burtonsville Town Center):		99%					
	Total LATR Adjusted Vehicular Trips per ITE Trip Generation Manual, 11th Edition (Auto Driver at 71.6%):		66	64	130	74	76	150
	Total Person Trips:		93	89	182	103	106	209
	Auto Driver:	71.6%	66	64	130	74	76	150
	Auto Passenger:	24.3%	22	22	44	25	26	51
	Transit:	1.0%	1	1	2	1	1	2
	Non-Motorized:	3.1%	4	2	6	3	3	6

	AM Peak			PM Peak		
	In	Out	Total	In	Out	Total
Net Person Trips:	168	174	342	121	117	238
Net Vehicular Trips:	121	124	245	86	84	170

NOTES:

- The Montgomery County Growth and Infrastructure Policy states that projects with more than 50 peak hour person trips require a transportation facilities analysis based on GIP Requirements.
- Trip Generation Rates obtained from the ITE Trip Generation Manual, 11th Edition.

Transportation Facilities Analysis	Trip Generation for Site	Exhibit 2
Lenhart Traffic Consulting, Inc. Traffic Engineering & Transportation Planning		

Section 2 Motor Vehicle System Adequacy

Section 2.1 – Adequacy Requirements & Study Area

Adequacy Requirements

Based on the requirements of the LATR for the Burtonsville Town Center Transportation Policy Area, an Orange Policy Area, each study intersection must be evaluated using the Highway Capacity Manual (HCM) methodology. Under the Guidelines, intersections in the Burtonsville Town Center Policy Area with an average intersection delay of 71 seconds or less are considered adequate.

Study Area

The study intersections were determined as part of the scoping process with M-NCPPC and are shown on Exhibit 1a.

Section 2.2 – Existing Conditions

Description of Roadway Network

The key roads in the study area are listed below:

- Old Columbia Pike is four- to six-lane (two to three in each direction) roadway with a north-south orientation. The posted speed limit is 45 MPH within the vicinity of the site.
- MD 198 is a four-lane (two in each direction) roadway with an east-west orientation. The posted speed limit is 25 MPH within the vicinity of the site, but increases to 35 MPH to the east and west of the site.

Lane Configurations

The Lane Use & Traffic Control Devices are shown on **Exhibit 3**.

Existing Traffic Counts

Peak hour turning movement counts were conducted and the results are shown on **Exhibit 4** and represent the Existing Peak Hour Volumes.

Section 2.3 – Background Conditions

Approved Background Developments and Road Improvements

The redevelopment of the Burtonsville Crossing shopping center has been included as a background development for this project. This includes the currently vacant portion of the shopping center along with the proposed redevelopment. The trip generation and assignment for the Burtonsville Crossing shopping center is included in Appendix C. Exhibit C-8 shows the total background development trip assignment.

The Burtonsville Access Road, a Montgomery County project, is funded for construction and is anticipated to begin construction in 2024. The project will provide a new roadway between MD 198 (at Study Intersection #8) and the School Access Road. The project is not expected to result in substantial modifications to travel patterns at the study intersections.

Background Traffic Volumes

The Background Peak Hour Volumes are shown on **Exhibit 5**. These volumes include the existing peak hour volumes and the trips generated by the vacant shopping center (Exhibit C-8).

Section 2.4 – Total Conditions

Site Trip Generation

The property is currently developed with an 8,100 square foot furniture store and 2,496 square foot convenience store with four fuel dispensers, each with two fueling positions. The property is proposed to be redeveloped with a 5,919 square foot convenience store with six fuel dispensers, each with two fueling positions. The trip generation for the site is shown on **Exhibit 6**.

Proposed Improvements

The following road improvements are proposed by the applicant, and are shown on **Exhibit 7**:

- Construct traffic signal at intersection of MD 198 & Site Access/Shopping Center. With the redevelopment of the site, the western full movement access point is proposed to be signalized. A traffic signal warrant analysis was conducted for the intersection and is included as Appendix D of this report.

The results of the traffic signal warrant analysis show that a traffic signal is warranted at this location under *existing* conditions. M-NCPPC and MDOT-SHA Staff have previously indicated their desire for the traffic signal to be installed prior to opening of the development. MDOT-SHA also previously reviewed the traffic signal warrant analysis and concurred that the signal would be allowed to move forward when the development began to move forward.

- Reconstruct eastbound approach of MD 198 & Old Columbia Pike/US 29 SB On Ramp. The eastbound approach of MD 198 & Old Columbia Pike/US 29 SB On Ramp currently includes a left-turn lane, three through lanes, and an uncontrolled channelized right-turn lane to US 29 SB. With the redevelopment of the site, the eastbound approach will be reconstructed to remove the free right-turn along the site's frontage, so will consist of a left-turn lane, two through lanes, and a shared through/right-turn lane.

Site Trip Distribution & Trip Assignment

The primary trip distribution and assignment for the site is shown on **Exhibit 8a** and the pass-by trip assignment is shown on **Exhibit 8b**.

Total Traffic Volumes

The Total Peak Hour Volumes are shown on **Exhibit 9**.

Projected Traffic Operations

Based on the requirements of the LATR for the Burtonsville Town Center Transportation Policy Area, an Orange Policy Area, each study intersection must be evaluated using the Highway Capacity Manual (HCM) and Critical Lane Volume (CLV) methodologies. Under the Guidelines, intersections in the Burtonsville Town Center Policy Area with an average intersection delay of 71 seconds or less and a CLV of 1,550 or less are considered adequate.

Exhibit 10a presents the results of the HCM analysis. As shown, each intersection will operate with an average delay below 71 seconds and should therefore be considered to operate adequately. The HCM analysis worksheets are included in Appendix B.

Exhibit 10b presents the results of the CLV analysis. As shown, each intersection will operate with a CLV below 1,550 and should therefore be considered to operate adequately. The CLV analysis worksheets are included in Appendix B.

SimTraffic simulation software was used to determine the 95th percentile queues for

movements containing dedicated storage space at each study intersection. The results of the queuing analysis is shown on **Exhibit 11**.

Results of Analysis

Analyses using the HCM and CLV methodologies show all intersections operate with an average delay of 71 seconds or less and a CLV of 1,550 or less under Total Traffic Conditions. Hence, all intersections meet the LATR requirements for motor vehicle adequacy.

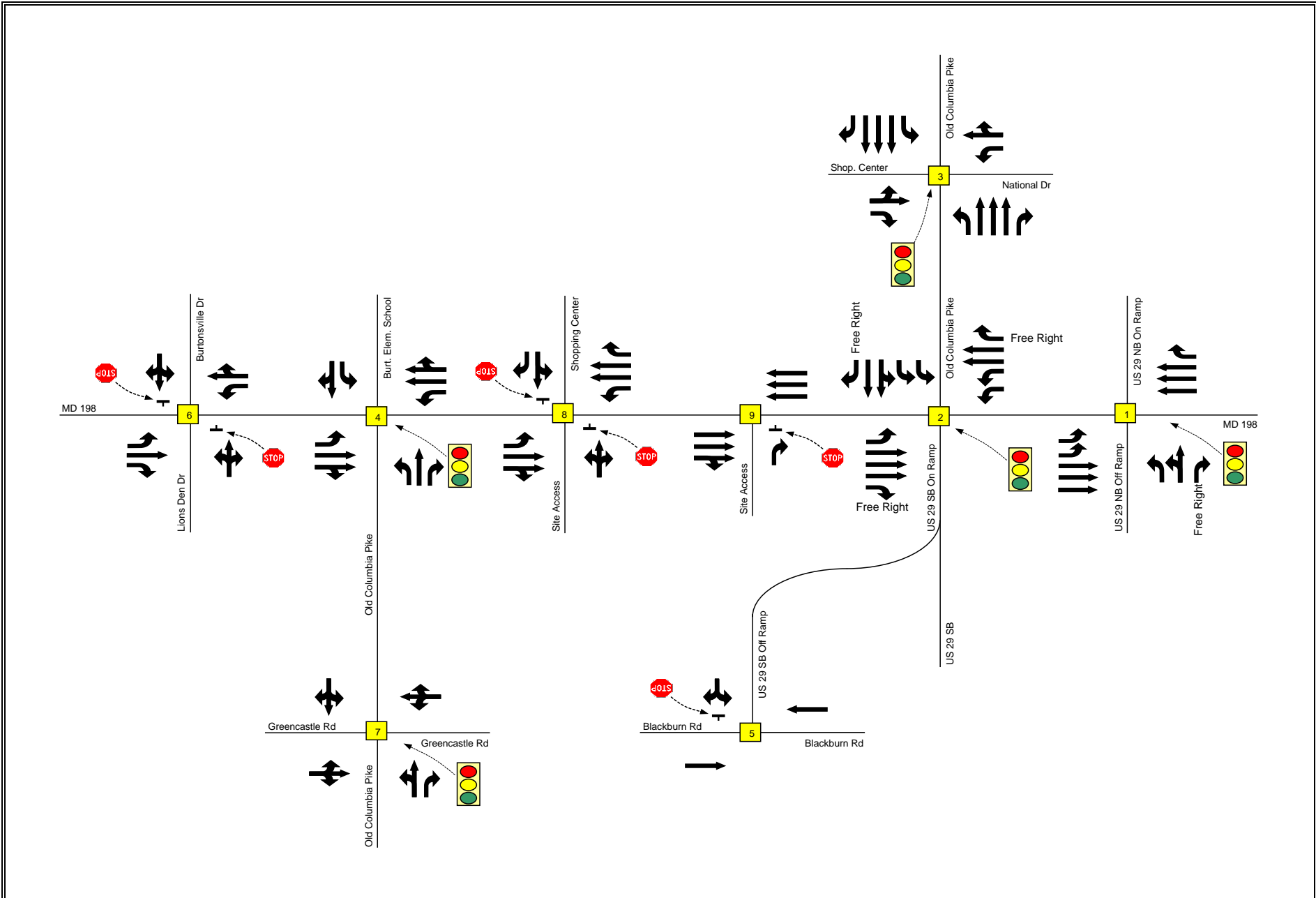

Traffic Impact Analysis

Lenhart Traffic Consulting, Inc.
Traffic Engineering & Transportation Planning

Existing Lane Use & Traffic Control Devices

Key: xx = AM Peak Vol's (xx) = PM Peak Vol's

Exhibit
3

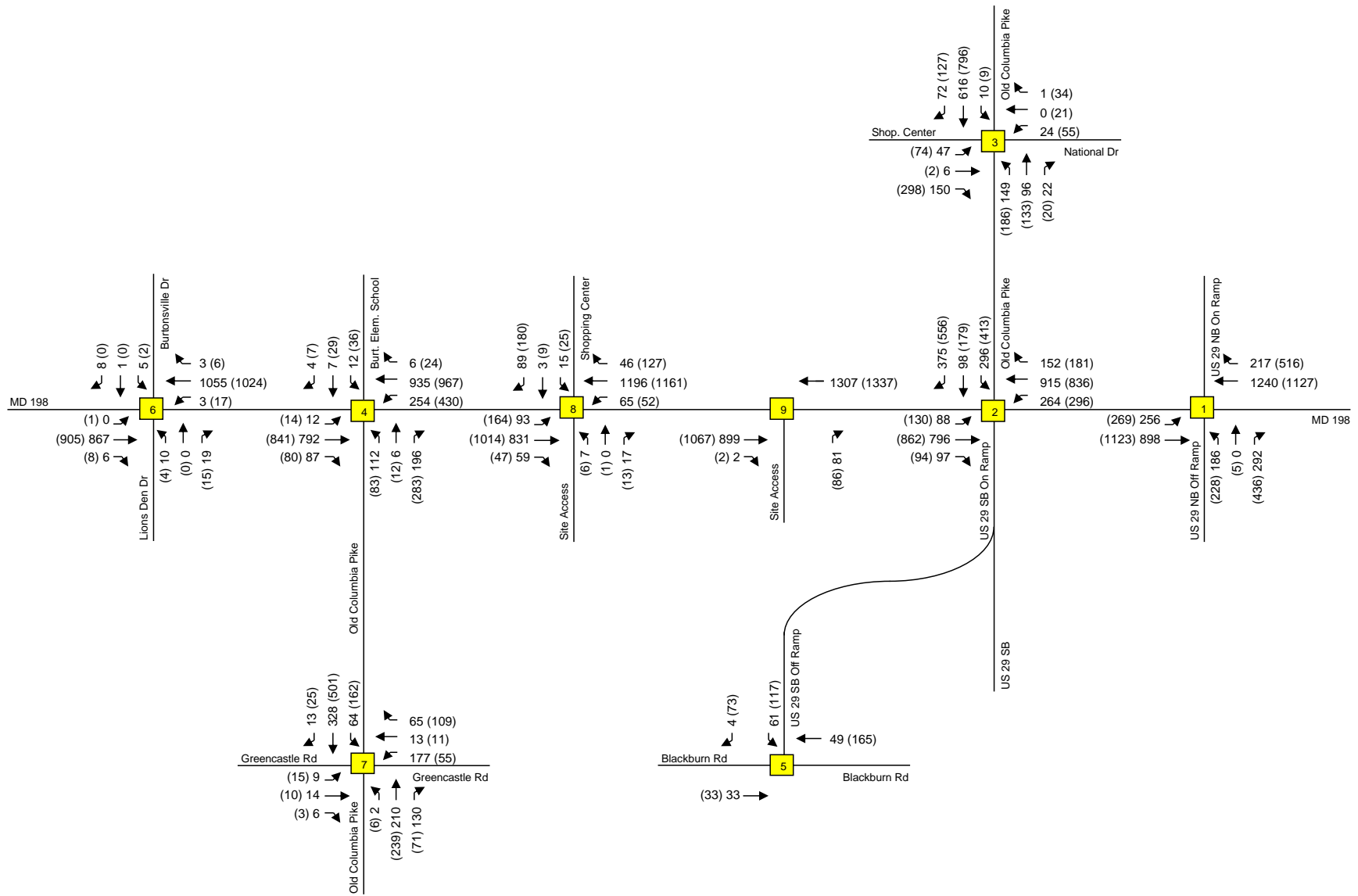

Traffic Impact Analysis

Lenhart Traffic Consulting, Inc.

Traffic Engineering & Transportation Planning

Existing Peak Hour Volumes

Key: xx = AM Peak Vol's (xx) = PM Peak Vol's

Exhibit

4

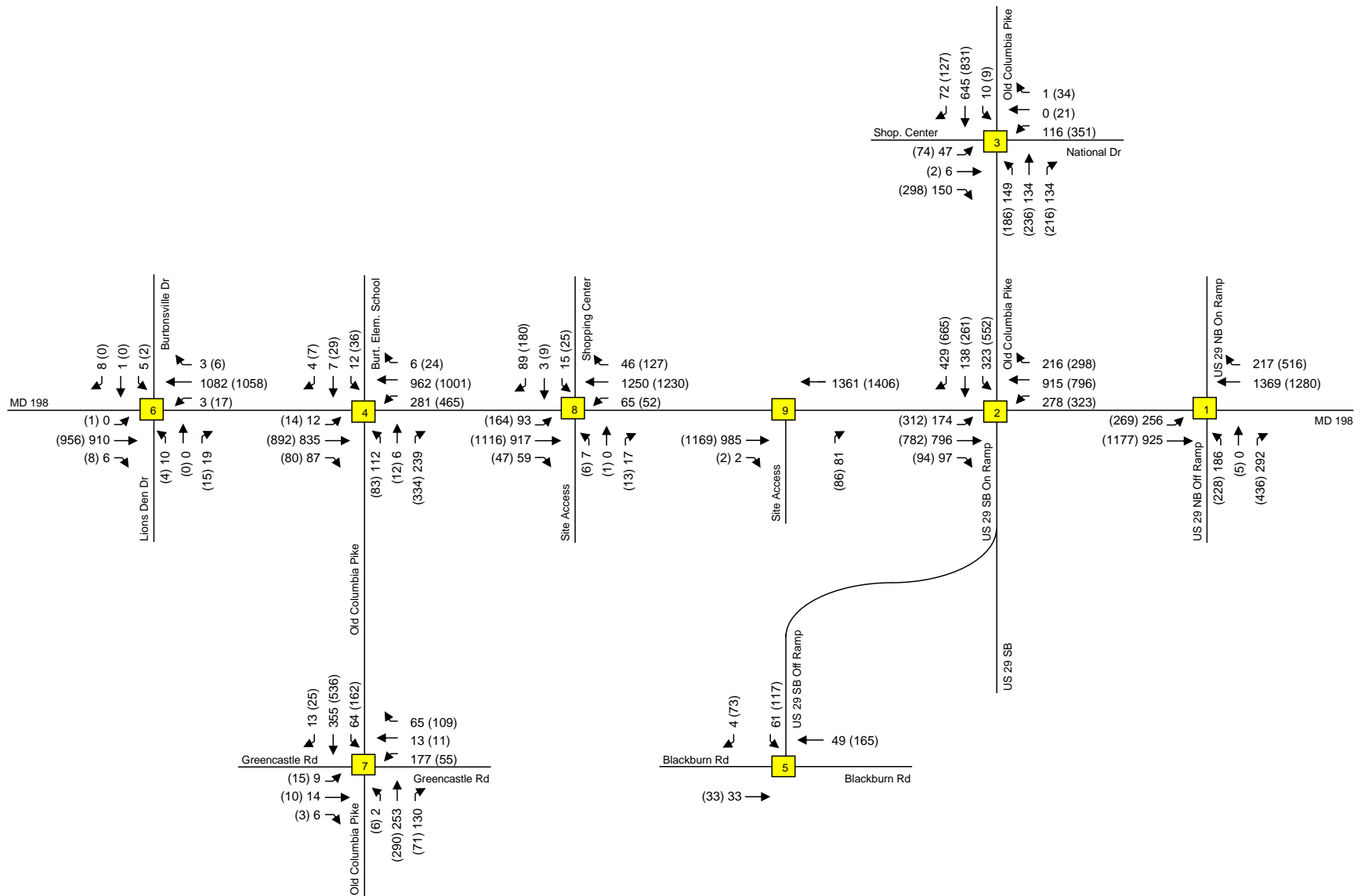

Traffic Impact Analysis

Lenhart Traffic Consulting, Inc.

Traffic Engineering & Transportation Planning

Background Peak Hour Volumes

Key: xx = AM Peak Vol's (xx) = PM Peak Vol's

**Exhibit
5**

Trip Generation Rates

Convenience Store / Gas Station w/GFA from 5.5-10 ksf (VFP, ITE-945)

Morning Trips = 31.60 x Fueling Positions
 Evening Trips = 26.90 x Fueling Positions

Trip Distribution (In/Out)

50/50
 50/50

Furniture Store (ksf, ITE-890)

Morning Trips = 0.24 x ksf + 0.94
 Ln(Evening Trips) = 0.85 x Ln(ksf) - 0.18

Trip Distribution (In/Out)

71/29
 47/53

Convenience Store / Gas Station w/GFA from 2-4 ksf (VFP, ITE-945)

Morning Trips = 16.06 x Fueling Positions
 Evening Trips = 18.42 x Fueling Positions

Trip Distribution (In/Out)

50/50
 50/50

Trip Generation Totals

			AM Peak			PM Peak		
			In	Out	Total	In	Out	Total
Proposed	Convenience Store / Gas Station w/GFA from 4-5.5 ksf (VFP, ITE-945)	12 Fueling Positions	189	190	379	161	162	323
		<i>Pass-by Percentage (76% AM / 75% PM):</i>	-144	-144	-288	-120	-122	-242
Proposed Vehicular Trips per ITE Trip Generation Manual, 11th Edition:			189	190	379	161	162	323
LATR Vehicle Trip Generation Rate Adjustment Factor (Burtonsville Town Center):			99%					
Total LATR Adjusted Vehicular Trips per ITE Trip Generation Manual, 11th Edition (Auto Driver at 71.6%):			187	188	375	160	160	320
Total Person Trips:			261	263	524	224	223	447
Auto Driver: 71.6%			187	188	375	160	160	320
Auto Passenger: 24.3%			63	64	127	55	54	109
Transit: 1.0%			2	3	5	2	2	4
Non-Motorized: 3.1%			9	8	17	7	7	14

			AM Peak			PM Peak		
			In	Out	Total	In	Out	Total
Existing	Furniture Store (ksf, ITE-890)	8,100 sq.ft.	2	1	3	2	3	5
	Convenience Store / Gas Station w/GFA from 2-4 ksf (VFP, ITE-945)	8 Fueling Positions	64	64	128	73	74	147
		<i>Pass-by Percentage (60% AM / 56% PM):</i>	-39	-38	-77	-41	-41	-82
Existing Vehicular Trips per ITE Trip Generation Manual, 11th Edition:			66	65	131	75	77	152
LATR Vehicle Trip Generation Rate Adjustment Factor (Burtonsville Town Center):			99%					
Total LATR Adjusted Vehicular Trips per ITE Trip Generation Manual, 11th Edition (Auto Driver at 71.6%):			66	64	130	74	76	150
Total Person Trips:			93	89	182	103	106	209
Auto Driver: 71.6%			66	64	130	74	76	150
Auto Passenger: 24.3%			22	22	44	25	26	51
Transit: 1.0%			1	1	2	1	1	2
Non-Motorized: 3.1%			4	2	6	3	3	6

	AM Peak			PM Peak		
	In	Out	Total	In	Out	Total
Net Person Trips:	168	174	342	121	117	238
Net Primary Vehicular Trips:	16	18	34	7	3	10
Net Pass-by Vehicular Trips:	105	106	211	79	81	160

NOTES:

- The Montgomery County Growth and Infrastructure Policy states that projects with more than 50 peak hour person trips require a transportation facilities analysis based on GIP Requirements.
- Trip Generation Rates obtained from the ITE Trip Generation Manual, 11th Edition.

Transportation Facilities Analysis	Trip Generation for Site	Exhibit 6
Lenhart Traffic Consulting, Inc. Traffic Engineering & Transportation Planning		

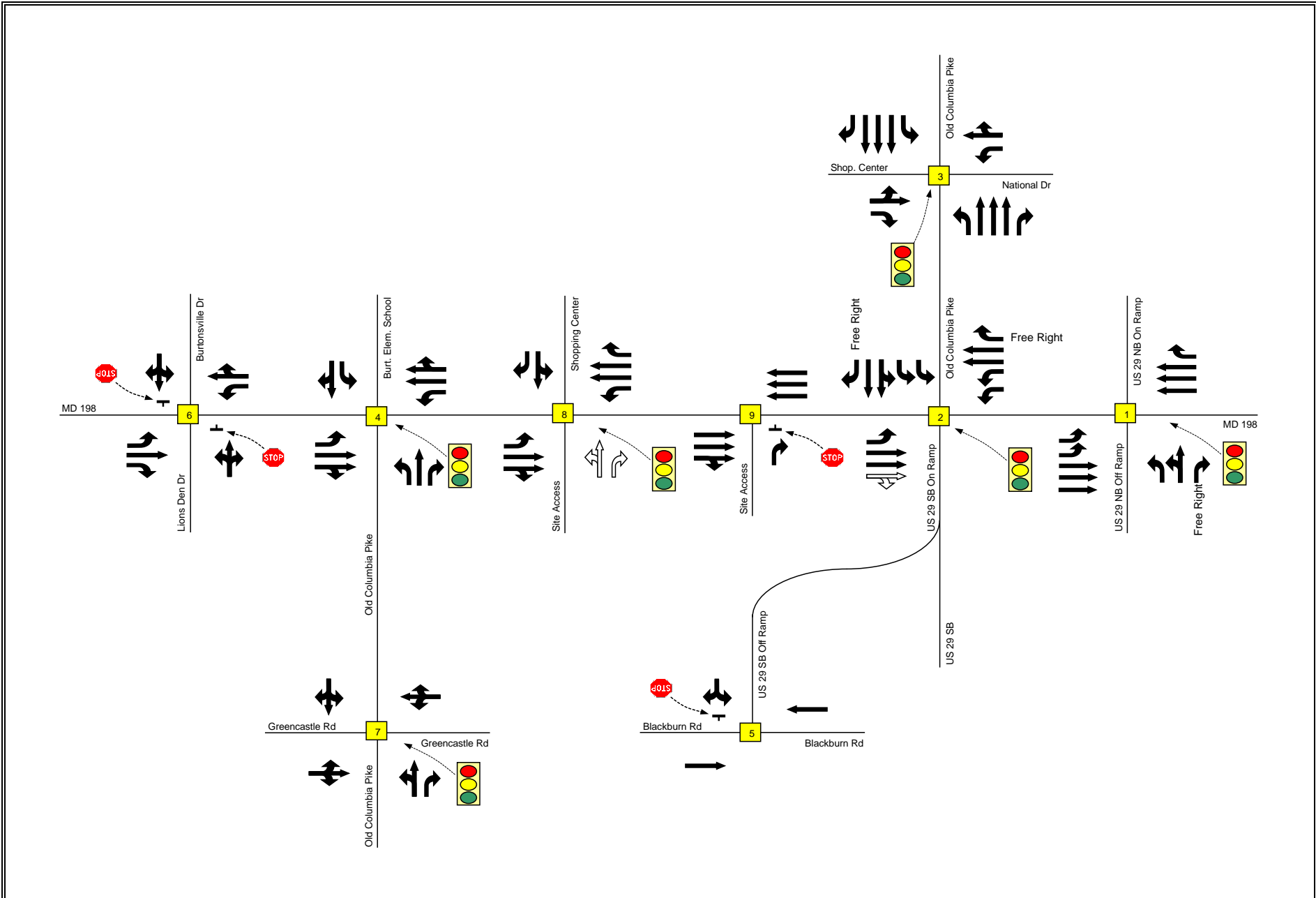

Traffic Impact Analysis

Lenhart Traffic Consulting, Inc.
Traffic Engineering & Transportation Planning

Proposed Lane Use & Traffic Control Devices

Key: - Existing - Proposed

Exhibit
7

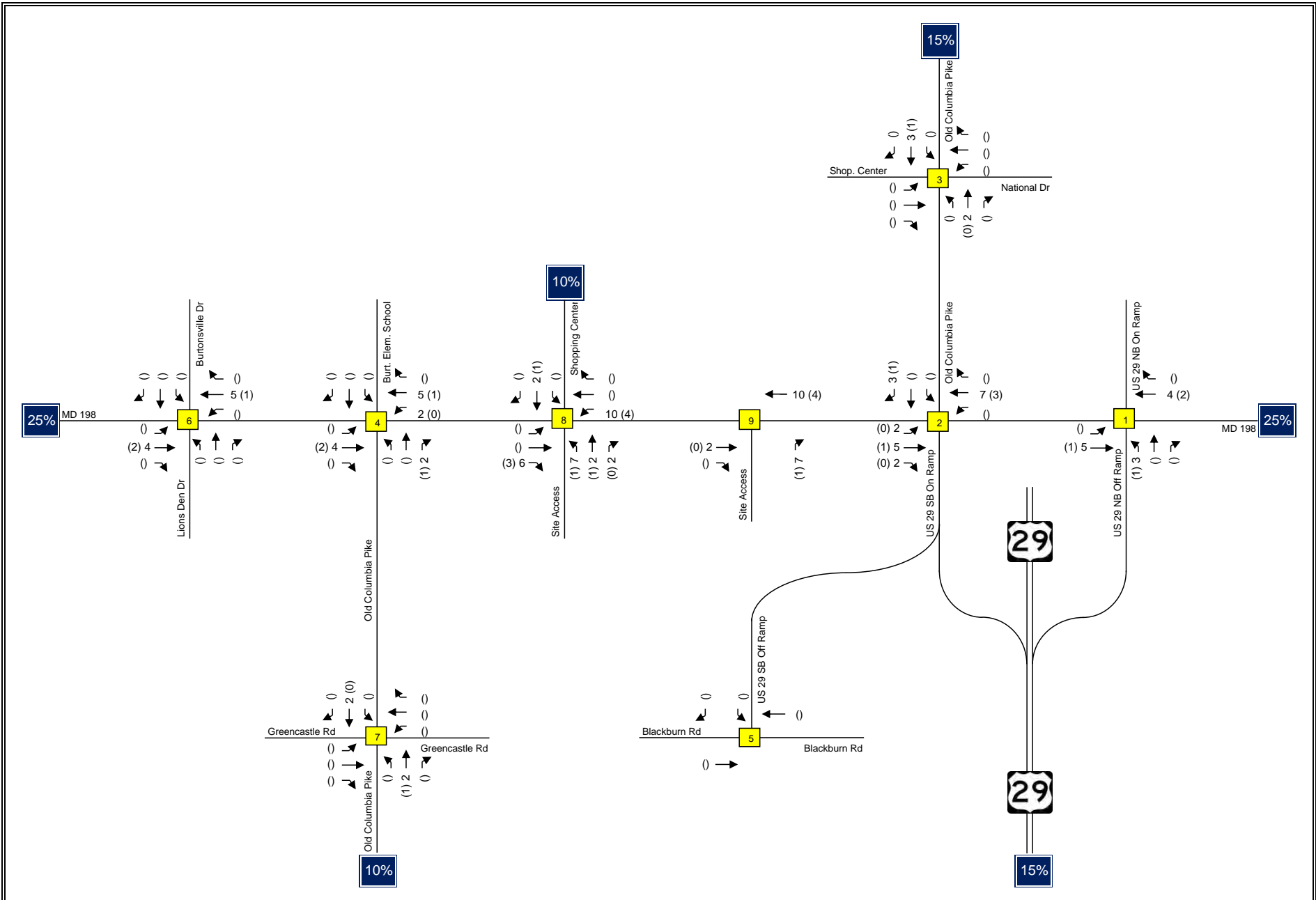

Traffic Impact Analysis
 Lenhart Traffic Consulting, Inc.
 Traffic Engineering & Transportation Planning

Primary Trip Assignment
 for Site

Key: xx = AM Peak Vol's (xx) = PM Peak Vol's

Exhibit
 8a

NOTE:

50% of pass-by trips are assumed along eastbound MD 198 and 50% along westbound MD 198. For inbound trips along eastbound MD 198, 75% are assumed to enter the site at Intersection 8 and 25% at Intersection 9. For outbound trips along eastbound MD 198, 75% are assumed to exit at Intersection 9 and 25% at Intersection 8.

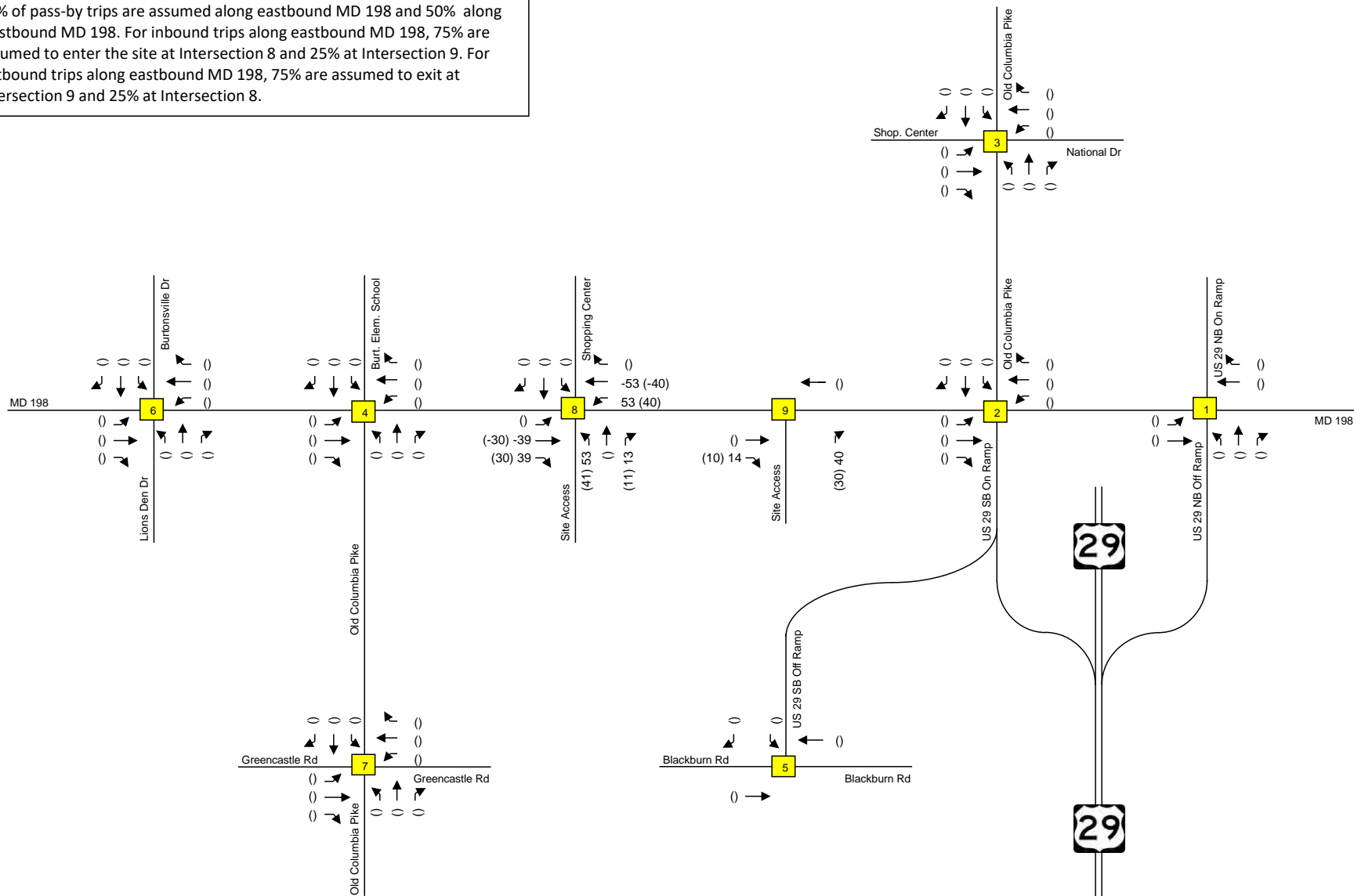

Traffic Impact Analysis

Lenhart Traffic Consulting, Inc.

Traffic Engineering & Transportation Planning

**Primary Trip Assignment
for Site**

Key: xx = AM Peak Vol's (xx) = PM Peak Vol's

**Exhibit
8b**

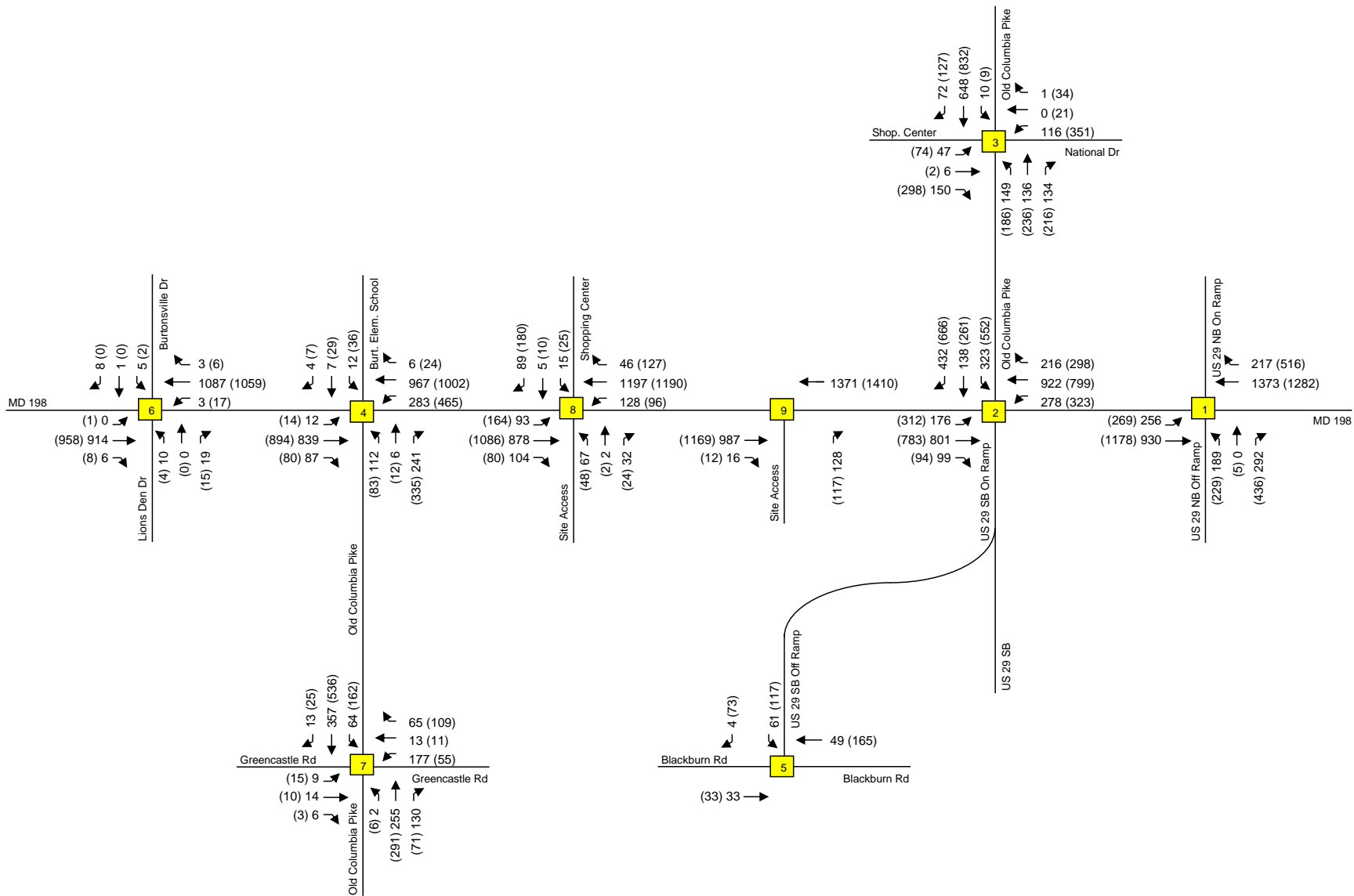

Traffic Impact Analysis

Lenhart Traffic Consulting, Inc.

Traffic Engineering & Transportation Planning

Total Peak Hour Volumes

Key: xx = AM Peak Vol's (xx) = PM Peak Vol's

Exhibit 9

CLV Level-of-Service Results

Morning Peak Hour	Existing CLV	Background CLV	Total CLV	Meets Adequacy?
1). MD 198 & US 29 NB Ramps	A / 957	B / 1009	B / 1013	Y
2). MD 198 & Old Columbia Pike/US 29 SB On Ramp	A / 808	A / 931	A / 937	Y
3). Old Columbia Pike & National Drive	A / 477	A / 581	A / 582	Y
4). MD 198 & Old Columbia Pike	A / 860	A / 911	A / 915	Y
5). US 29 SB Off Ramp & Blackburn Road	A / 114	A / 114	A / 114	Y
6). MD 198 & Lions Den Drive/Burtonsville Drive	B / 1093	B / 1120	B / 1125	Y
7). Old Columbia Pike & Greencastle Road	A / 753	A / 780	A / 782	Y
8). MD 198 & Site Access/Shopping Center	A / 791	A / 821	A / 874	Y
9). MD 198 & Site Access	A / 441	A / 476	A / 529	Y
Evening Peak Hour	Existing CLV	Background CLV	Total CLV	Meets Adequacy?
1). MD 198 & US 29 NB Ramps	B / 1041	B / 1041	B / 1042	Y
2). MD 198 & Old Columbia Pike/US 29 SB On Ramp	A / 916	C / 1197	C / 1198	Y
3). Old Columbia Pike & National Drive	A / 671	A / 981	A / 982	Y
4). MD 198 & Old Columbia Pike	B / 1056	B / 1119	B / 1120	Y
5). US 29 SB Off Ramp & Blackburn Road	A / 355	A / 355	A / 355	Y
6). MD 198 & Lions Den Drive/Burtonsville Drive	B / 1052	B / 1086	B / 1087	Y
7). Old Columbia Pike & Greencastle Road	B / 1052	B / 1087	B / 1087	Y
8). MD 198 & Site Access/Shopping Center	A / 849	A / 887	A / 923	Y
9). MD 198 & Site Access	A / 514	A / 554	A / 589	Y

NOTES:

1. All intersections satisfy LATR Guidelines for the Burtonsville Town Center Policy Area

Transportation Impact Analysis



**Results of CLV
Level-of-Service Analyses**

**Exhibit
10a**

HCM Level-of-Service Results

Morning Peak Hour	Existing Delay	Background Delay	Total Delay	Meets Adequacy?
1). MD 198 & US 29 NB Ramps	C / 24.6	C / 24.4	C / 24.5	Y
2). MD 198 & Old Columbia Pike/US 29 SB On Ramp	D / 35.1	D / 42.5	D / 46.0	Y
3). Old Columbia Pike & National Drive	A / 8.5	B / 11.5	B / 11.5	Y
4). MD 198 & Old Columbia Pike	B / 16.4	B / 17.1	C / 20.5	Y
5). US 29 SB Off Ramp & Blackburn Road	A / 4.1	A / 4.1	A / 4.1	Y
6). MD 198 & Lions Den Drive/Burtonsville Drive	A / 1.5	A / 1.7	A / 1.7	Y
7). Old Columbia Pike & Greencastle Road	B / 10.8	B / 10.8	B / 10.8	Y
8). MD 198 & Site Access/Shopping Center	A / 2.5	A / 2.5	D / 39.0	Y
9). MD 198 & Site Access	A / 0.4	A / 0.4	A / 0.5	Y
Evening Peak Hour	Existing Delay	Background Delay	Total Delay	Meets Adequacy?
1). MD 198 & US 29 NB Ramps	C / 32.3	C / 32.7	C / 32.6	Y
2). MD 198 & Old Columbia Pike/US 29 SB On Ramp	C / 35.0	D / 50.8	D / 53.3	Y
3). Old Columbia Pike & National Drive	B / 12.8	B / 19.2	B / 19.2	Y
4). MD 198 & Old Columbia Pike	C / 24.4	C / 30.0	C / 27.7	Y
5). US 29 SB Off Ramp & Blackburn Road	A / 5.4	A / 5.4	A / 5.4	Y
6). MD 198 & Lions Den Drive/Burtonsville Drive	A / 0.6	A / 0.6	A / 0.6	Y
7). Old Columbia Pike & Greencastle Road	A / 9.6	B / 10.2	B / 10.2	Y
8). MD 198 & Site Access/Shopping Center	A / 5.4	A / 5.9	C / 25.6	Y
9). MD 198 & Site Access	A / 0.4	A / 0.4	A / 0.4	Y

NOTES:

1. All intersections satisfy LATR Guidelines for the Burtonsville Town Center Policy Area

Transportation Impact Analysis



LENHART TRAFFIC CONSULTING, INC.
 645 BALTIMORE ANNAPOLIS BLVD, SUITE 214
 SEVERNA PARK, MD 21146
 www.lenharttraffic.com

Results of HCM
 Level-of-Service Analyses

**Exhibit
 10b**

SimTraffic 95th Percentile Queuing Results

Morning Peak Hour	Background Queue	Total Queue
1). MD 198 & US 29 NB Ramps Eastbound Left	151 feet	141 feet
2). MD 198 & Old Columbia Pike/US 29 SB On Ramp Eastbound Left Westbound Left	193 feet 151 feet	189 feet 123 feet
3). Old Columbia Pike & National Drive Northbound Left Southbound Left	146 feet 19 feet	111 feet 27 feet
4). MD 198 & Old Columbia Pike Eastbound Left Westbound Left Northbound Left	39 feet 212 feet 134 feet	44 feet 213 feet 156 feet
5). US 29 SB Off Ramp & Blackburn Road	--	--
6). MD 198 & Lions Den Drive/Burtonsville Drive Eastbound Left Westbound Left	0 feet 11 feet	0 feet 15 feet
7). Old Columbia Pike & Greencastle Road	--	--
8). MD 198 & Site Access/Shopping Center Eastbound Left Westbound Left	80 feet 36 feet	140 feet 122 feet
9). MD 198 & Site Access	--	--
Evening Peak Hour	Background Queue	Total Queue
1). MD 198 & US 29 NB Ramps Eastbound Left	121 feet	102 feet
2). MD 198 & Old Columbia Pike/US 29 SB On Ramp Eastbound Left Westbound Left	185 feet 136 feet	226 feet 127 feet
3). Old Columbia Pike & National Drive Northbound Left Southbound Left	206 feet 25 feet	193 feet 27 feet
4). MD 198 & Old Columbia Pike Eastbound Left Westbound Left Northbound Left	71 feet 197 feet 118 feet	53 feet 185 feet 113 feet
5). US 29 SB Off Ramp & Blackburn Road	--	--
6). MD 198 & Lions Den Drive/Burtonsville Drive Eastbound Left Westbound Left	4 feet 35 feet	0 feet 40 feet
7). Old Columbia Pike & Greencastle Road	--	--
8). MD 198 & Site Access/Shopping Center Eastbound Left Westbound Left	211 feet 37 feet	199 feet 90 feet
9). MD 198 & Site Access	--	--

NOTES:

1. For movements consisting of multiple lanes, the average storage capacity and queue per lane is reported above.

Transportation Impact Analysis



LENHART TRAFFIC CONSULTING, INC.
645 BALTIMORE ANNAPOLIS BLVD, SUITE 214
SEVERNA PARK, MD 21146
www.lenharttraffic.com

**Results of SimTraffic
95th Percentile Queuing Analyses**

**Exhibit
11**

Section 3 Pedestrian System Adequacy

Section 3.1 – Adequacy Requirements & Study Area

Per the GIP, a pedestrian system adequacy analysis is required as the site will generate more than 50 peak hour person trips. Specifically, as detailed on Exhibit 2, the site will generate 342 AM peak hour person trips and 238 PM peak hour person trips. Table 1 of the LATR Guidelines provides the required study area from the site frontage that is to be analyzed for pedestrian system adequacy based on the peak hour person trips and is provided below. As shown, a 900-foot walkshed from the site frontage must be analyzed.

Table 1. Pedestrian Adequacy Test Scoping

Peak-Hour Person Trips Generated	Red and Orange Policy Area Walkshed*	Yellow and Green Policy Area Walkshed*
50 – 99	400'	250'
100 – 199	750'	400'
200 – 349	900'	500'
350 or more	1,000'	600'

As detailed in the GIP, there are three components for the Pedestrian System Adequacy Test that must be analyzed within this 900-foot study area. They are as follows:

- Pedestrian Level of Comfort (PLOC)
- Street Lighting
- ADA Compliance

The analysis of these components are detailed in the sections below.

Section 3.2 – Pedestrian Level of Comfort (PLOC)

Per the GIP, “Pedestrian system adequacy is defined as providing a “Somewhat Comfortable” or “Very Comfortable” PLOC score on streets and intersections for roads classified as Primary Residential or higher (excluding Controlled Major Highways and Freeways, and their ramps), within a certain walkshed from the site frontage, specified in Table 1. **Exhibit 12** shows the PLOC evaluation area for this project.

The Montgomery County Planning Department publishes a map detailing the PLOC for roadways within Montgomery County. A copy of the PLOC map for the area in the vicinity of the site is provided on **Exhibit 13**. Segments of the study area are indexed on

Exhibit 13 with discussion of the PLOC for these segments contained on **Exhibits 14a-14d**

PLOC Deficiencies

As shown on Exhibits 14a-14d, several sections of pathway and crossings within the 900-foot walkshed do not meet the PLOC standards. Potential improvements are identified that improve the PLOC rating to adequate levels. Recommended improvements to the pedestrian system are discussed in Section 3.5.

Section 3.3 – Street Lighting

Street lighting within the study area was analyzed, with the results contained within Appendix E. While some street lighting barely exceeds the maximum spacing and distance to curb/sidewalk requirements, these discrepancies are typically very minor and the street lighting in the study area appears reasonable. It is therefore recommended that the off-site improvement budget can be more effectively utilized on the improvements recommended in Section 3.5, rather than on street lighting.

Section 3.4 – ADA Compliance

Exhibit 15 provides the ADA compliance evaluation area in the vicinity of the site. Note that Section TL2.3 – Item 3 which discusses the ADA compliance portion of the Pedestrian System Adequacy states that, “The applicant must fix Americans with Disabilities Act (ADA) noncompliance issues within a certain walkshed from the site frontage equivalent to half the walkshed specified in Table T4. Therefore, the required walkshed for which the developer must address ADA noncompliance is 450 feet. The pedestrian facilities, including pathways and curb ramps, located within the 450-foot walkshed were found to meet ADA compliance guidelines.

Section 3.5 – Pedestrian System Adequacy Evaluation

Based on the above analyses of the PLOC, street lighting, and ADA compliance, the offsite pedestrian system improvements identified below should be considered by the applicant. It is recommended that the improvements are focused on pedestrian facilities at the intersection of MD 198 & Old Columbia Pike/US 29 SB Ramps. The applicant is constructing significant improvements along the property frontage, including a separated bike lane, sidepath, and breezeway, and off-site improvements should be made to connect with the new facilities.

Coordination with Montgomery County Staff will be required to determine the scope of specific improvements, but the following improvements could be recommended, provided they can be accomplished within the applicant's cost cap, and pending a detailed review of feasibility. The list of proposed improvements will be further refined, including 10% plans and cost-estimates, in coordination with staff.

- Install high-visibility crosswalks at the intersection of MD 198 & Old Columbia Pike/US 29 SB Ramps for movements that do not currently have high-visibility crossings.
- Extend the planned breezeway along US 29 SB Ramp to the south beyond the property frontage.

In addition to the above improvements, it is recommended that MDOT SHA and/or Montgomery County Staff consider extending the reduced speed limit zone of 25 MPH to the east along MD 198 to the intersection with the US 29 NB ramps. Reducing the speed limit to 25 MPH for this segment will significantly improve pedestrian level of comfort and safety for segments along MD 198 in this area.

Designated as Primary Residential or Higher (excluding Controlled Major Highways and Freeways, and their ramps):

900 Foot Radius from Site along roadways designated:



Transportation Facilities Analysis

Lenhart Traffic Consulting, Inc.

Traffic Engineering & Transportation Planning

Pedestrian Evaluation Area
PLOC

**Exhibit
12**



<p>Transportation Facilities Analysis</p>	<p>PLOC Index</p>	<p>Exhibit 13</p>
<p>Lenhart Traffic Consulting, Inc. Traffic Engineering & Transportation Planning</p>		

Index #	Segment	Road Speed	On-street Parking?	Path Width	Buffer Type	Buffer Width	On-street Separation?	County PLOC Rating	Applicant PLOC Rating	Potential Improvements
1	West Side of US 29 Ramp	45	No	10 feet	Vegetation	>= 8 feet	No	Somewhat Comfortable	Somewhat Comfortable	N/A - Adequate PLOC.
2	West Side of US 29 Ramp	45	No	10 feet	Vegetation	5 to 8 feet	No	Uncomfortable	Uncomfortable	Construct buffer of at least 8 feet.
3	West Side of US 29 Ramp	45	No	10 feet	Vegetation	3 to 5 feet	No	Undesirable	Undesirable	The section of pathway along the property frontage is planned to be reconstructed with a 16 foot breezeway. Design will be coordinated with M-NCPPC Staff.
11	South Side of MD 198 East of Old Columbia Pike	25	No	8 feet	Vegetation	6 feet	No	Uncomfortable	Very Comfortable	PLOC database incorrectly designates the speed along MD 198. The posted speed limit has recently been reduced to 25 MPH.
13	South Side of MD 198 East of Driveway	35	No	8 feet	Vegetation	6 feet	No	Uncomfortable	Uncomfortable	Construct 8 foot buffer. Staff should consider extending the 25 MPH posted speed limit to the intersection with US 29 NB Ramps.
14	South Side of MD 198 East of Driveway	35	No	10 feet	N/A	N/A	No	Undesirable	Undesirable	Construct 8 foot buffer. Staff should consider extending the 25 MPH posted speed limit to the intersection with US 29 NB Ramps.
15	North Side of MD 198 East of Old Columbia Pike	35	No	7.5 feet	N/A	N/A	No	Undesirable	Undesirable	Construct 8 foot buffer. Staff should consider extending the 25 MPH posted speed limit to the intersection with US 29 NB Ramps.
16	North Side of MD 198 East of National Drive	35	No	8 feet	N/A	N/A	No	Undesirable	Undesirable	Construct 8 foot buffer. Staff should consider extending the 25 MPH posted speed limit to the intersection with US 29 NB Ramps.
17	East Side of Old Columbia Pike North of MD 198	45	No	6 feet	Vegetation	2 feet	No	Undesirable	Undesirable	Construct 8 foot buffer. Staff should consider reducing the speed limit along Old Columbia Pike to improve PLOC.
18	West Side of Old Columbia Pike North of MD 198	N/A	No	8 feet	Vegetation	>8 feet	No	Very Comfortable	Very Comfortable	N/A - Adequate PLOC.
19	West Side of Old Columbia Pike North of MD 198	45	No	6 feet	Vegetation	2 feet	No	Undesirable	Undesirable	Construct 8 foot buffer. Staff should consider reducing the speed limit along Old Columbia Pike to improve PLOC.

Transportation Facilities Analysis



Pedestrian Level of Comfort
Pathways Evaluation

Exhibit
14a

Index #	Segment	Road Speed	On-street Parking?	Path Width	Buffer Type	Buffer Width	On-street Separation?	County PLOC Rating	Applicant PLOC Rating	Potential Improvements
20	West Side of Old Columbia Pike North of MD 198	45	No	6 feet	Guard Rail	2 feet	No	Uncomfortable	Uncomfortable	Construct 8 foot buffer. Staff should consider reducing the speed limit along Old Columbia Pike to improve PLOC.
21	West Side of Old Columbia Pike South of National Drive	45	No	6 feet	Vegetation	2 to 5 feet	No	Undesirable	Undesirable	Construct 8 foot buffer. Staff should consider reducing the speed limit along Old Columbia Pike to improve PLOC.
22	West Side of Old Columbia Pike South of National Drive	45	No	6 feet	Vegetation	5 to 8 feet	No	Uncomfortable	Uncomfortable	Construct 8 foot buffer. Staff should consider reducing the speed limit along Old Columbia Pike to improve PLOC.
23	West Side of Old Columbia Pike South of National Drive	45	No	8 to 15 feet	Vegetation	10+ feet	No	Somewhat Comfortable	Somewhat Comfortable	N/A - Adequate PLOC.
28	North Side of MD 198 West of Old Columbia Pike	35 / 25	No	6 feet	Vegetation	2 feet	No	Undesirable	Uncomfortable	Construct 5 foot buffer. Montgomery County should consider extending the 25 MPH posted speed limit to the intersection with US 29 NB Ramps.

Transportation Facilities Analysis

Pedestrian Level of Comfort
Pathways Evaluation

Exhibit
14b



Index #	Segment	Intersection Control	Crosswalk Type	Median Type	Right Turn on Red Permitted?	Hot Right Turn?	Ramps?	Crossing Road Speed	Parallel Road Speed	Number of Lanes Crossed	County PLOC Rating	Applicant PLOC Rating	Potential Improvements
4	Intersection of MD 198 & Old Columbia Pike/US 29 SB Ramp: Eastbound Hot Right Turn	None	High Visibility	None	Yes	Yes	Both Sides	45	25	1	Undesirable	Undesirable	The channelized eastbound right-turn will be removed with the redevelopment of the site. The eastbound approach is proposed to consist of a left-turn lane, two through lanes, and a shared through/right-turn lane.
5	Intersection of MD 198 & Old Columbia Pike/US 29 SB Ramp: South Leg Crossing	Signalized	Standard	None	No	No	Both Sides	45	25	2	Uncomfortable	Uncomfortable	The channelized eastbound right-turn will be removed with the redevelopment of the site. The crossing at this location will be reconstructed. The speed limit along Old Columbia Pike should be reduced.
6	Intersection of MD 198 & Old Columbia Pike/US 29 SB Ramp: East Leg Crossing	Signalized	None	Raised Median	No	No	None	25	45	6+	Undesirable	Undesirable	No crossing is required at this location as a high-visibility crossing is provided to cross the west leg.
7	Intersection of MD 198 & Old Columbia Pike/US 29 SB Ramp: North Leg Crossing	Signalized	High Visibility	Pedestrian Refuge	No	No	Both Sides	45	25	6+	Uncomfortable	Uncomfortable	The speed limit along Old Columbia Pike should be reduced to at least 30 MPH to achieve adequate PLOC.
8	Intersection of MD 198 & Old Columbia Pike/US 29 SB Ramp: West Leg Crossing	Signalized	Standard	Pedestrian Refuge	No	No	Both Sides	25	45	6+	Uncomfortable	Uncomfortable	The speed limit along Old Columbia Pike should be reduced to at least 30 MPH to achieve adequate PLOC.
9	Intersection of MD 198 & Old Columbia Pike/US 29 SB Ramp: Southbound Hot Right Turn	None	High Visibility	None	Yes	Yes	Both Sides	45	25	1	Undesirable	Undesirable	Based on PLOC methodology, hot right turns automatically score Undesirable. Raised crosswalks, vehicle-slowng geometry, or other treatments to reduce speed or improve visibility can improve score to Uncomfortable.
10	Intersection of MD 198 & Old Columbia Pike/US 29 SB Ramp: Westbound Hot Right Turn	None	High Visibility	None	Yes	Yes	Both Sides	45	25	1	Undesirable	Undesirable	Based on PLOC methodology, hot right turns automatically score Undesirable. Raised crosswalks, vehicle-slowng geometry, or other treatments to reduce speed or improve visibility can improve score to Uncomfortable.

Transportation Facilities Analysis



Pedestrian Level of Comfort
Crossings Evaluation

Exhibit
14c

Index #	Segment	Intersection Control	Crosswalk Type	Median Type	Right Turn on Red Permitted?	Hot Right Turn?	Ramps?	Crossing Road Speed	Parallel Road Speed	Number of Lanes Crossed	County PLOC Rating	Applicant PLOC Rating	Potential Improvements
12	Intersection of MD 198 & Driveway: South Leg Crossing	Stop	None	None	N/A	No	Both Sides	25	35	2	Uncomfortable	Uncomfortable	Construct high visibility crosswalk. Montgomery County should consider extending the 25 MPH posted speed limit to the intersection with US 29 NB Ramps
25	Intersection of Old Columbia Pike & National Drive: West Leg Crossing	Signalized	Standard	Raised Median	Yes	No	Both Sides	25	45	4	Undesirable	Undesirable	Construct high visibility crosswalk. Montgomery County should consider reducing the speed limit along Old Columbia Pike.
26	Intersection of Old Columbia Pike & National Drive: South Leg Crossing	Signalized	Standard	Raised Median	Yes	No	Both Sides	45	25	6+	Undesirable	Undesirable	It is understood that this segment is being improved as part of the Burtonsville Crossing development.
27	Intersection of Old Columbia Pike & National Drive: East Leg Crossing	Signalized	Standard	None	Yes	No	Both Sides	25	45	3	Undesirable	Undesirable	It is understood that this segment is being improved as part of the Burtonsville Crossing development.
29	Intersection of MD 198 & Driveway: North Leg Crossing	Stop	None	None	N/A	No	Both Sides	25	25	2	Undesirable	Somewhat Comfortable	N/A - Adequate PLOC. Note, PLOC database incorrectly designates the posted speed limit along MD 198 at this location.

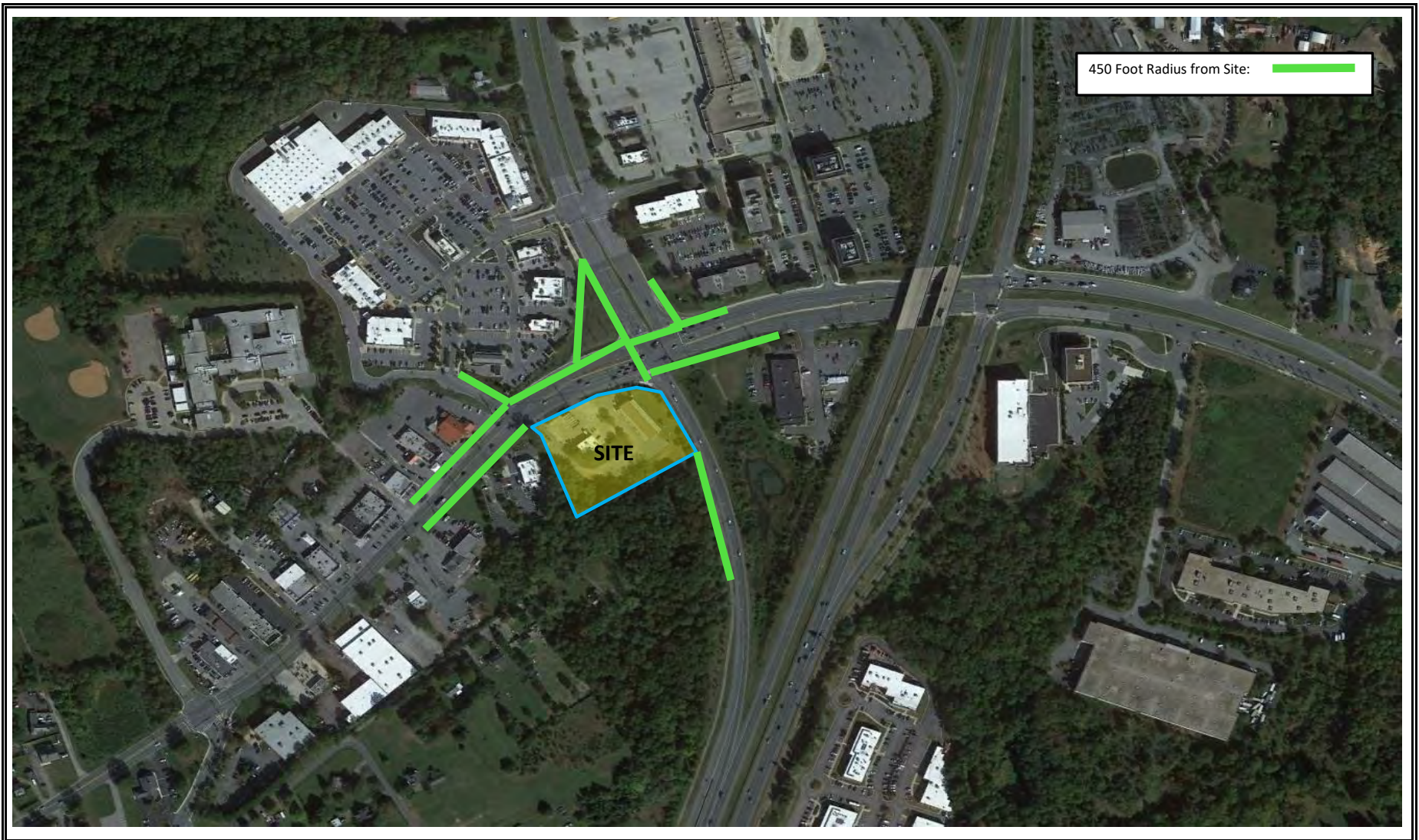

<p>Transportation Facilities Analysis</p>	<p>Pedestrian Evaluation Area ADA</p>	<p>Exhibit 15</p>
<p>Lenhart Traffic Consulting, Inc. Traffic Engineering & Transportation Planning</p>		

Section 4 Bicycle System Adequacy

Section 4.1 – Adequacy Requirements & Study Area

Per the GIP, a bicycle system adequacy analysis is required as the site will generate more than 50 peak hour person trips. Specifically, the site will generate 342 peak hour person trips during the AM peak hour and 238 peak hour person trips during the PM peak hour. Table 2 of the LATR Guidelines provides the required study area from the site frontage that is to be analyzed for bicycle system adequacy based on the peak hour person trips and is provided below. **Exhibit 16** shows the extent of the 900-foot study area.

Table 2. Bicycle Adequacy Test Scoping

Peak-Hour Person Trips Generated	Red and Orange Policy Areas	Yellow and Green Policy Areas
50 – 99	400'	250'
100 – 199	750'	400'
200 – 349	900'	500'
350 or more	1,000'	600'

As detailed in the GIP, bicycle system adequacy is defined as providing a low Level of Traffic Stress (LTS-2) for bicyclists. Per the above table, this LTS-2 must be maintained within the 900-foot walkshed of the site frontage with the consideration of both current or programmed bicycle infrastructure. If the existing and programmed bicycle infrastructure is not expected to ensure LTS-2, the developer must improve bicycle facilities in accordance with the Montgomery County Bicycle Master Plan within the study area.

Section 4.2 – Bicycle Master Plan

Exhibit 17 details the current Montgomery County Bicycle Master Plan in the vicinity of the site. A separated bike lane is planned along MD 198 between Old Columbia Pike to the west and the US 29 NB ramps. A separated bike lane is also planned along Old Columbia Pike throughout the study area.

Section 4.3 – Bicycle Level of Traffic Stress

Exhibit 18 details the Bicycle Level of Stress for the roadways in the vicinity of the site. As shown, Old Columbia Pike, MD 198, and the Burtonsville Town Center shopping center driveway are considered high level of traffic stress. **Exhibit 19** details the existing and planned bicycle facilities throughout the study area.

The applicant is proposing to construct a separated bike lane, sidepath, and breezeway along the property frontage along MD 198 and US 29 SB On Ramp.

Section 4.4 - Bicycle System Adequacy Analysis & Discussion

With the limitations of the maximum cost of off-site improvements for the project, it is unlikely that the applicant can construct significant portions of off-site bicycle facilities. However, it is recommended that the applicant pursues extending the breezeway to the south along the US 29 SB On Ramp beyond the site frontage, provided this can be accomplished within the applicant's cost cap, and pending a detailed review of feasibility. The list of proposed improvements will be further refined, including 10% plans and cost-estimates, in coordination with staff.

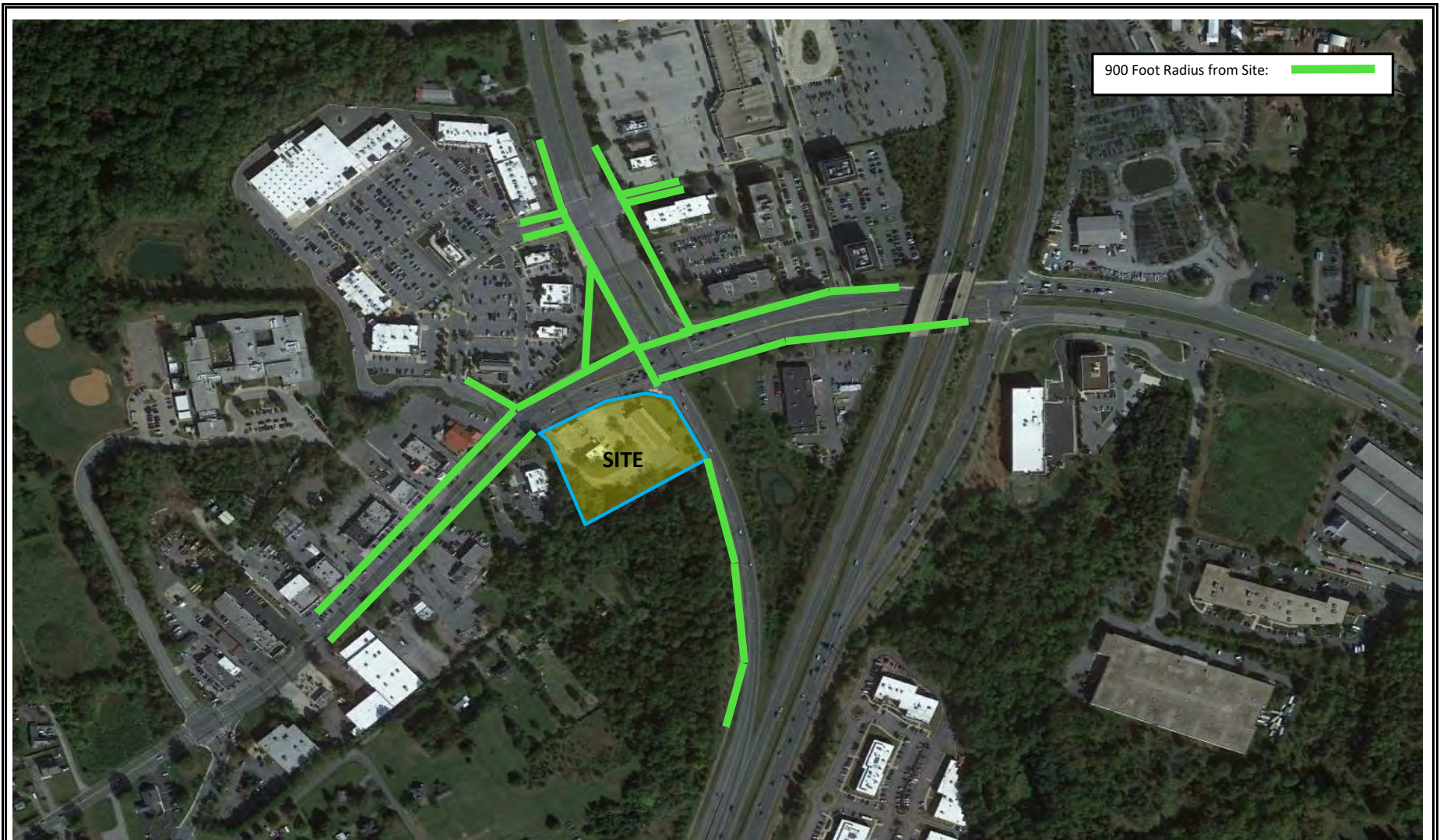

<p>Transportation Facilities Analysis</p>	<p>Bicycle Evaluation Area</p>	<p>Exhibit 16</p>
<p>Lenhart Traffic Consulting, Inc. Traffic Engineering & Transportation Planning</p>		

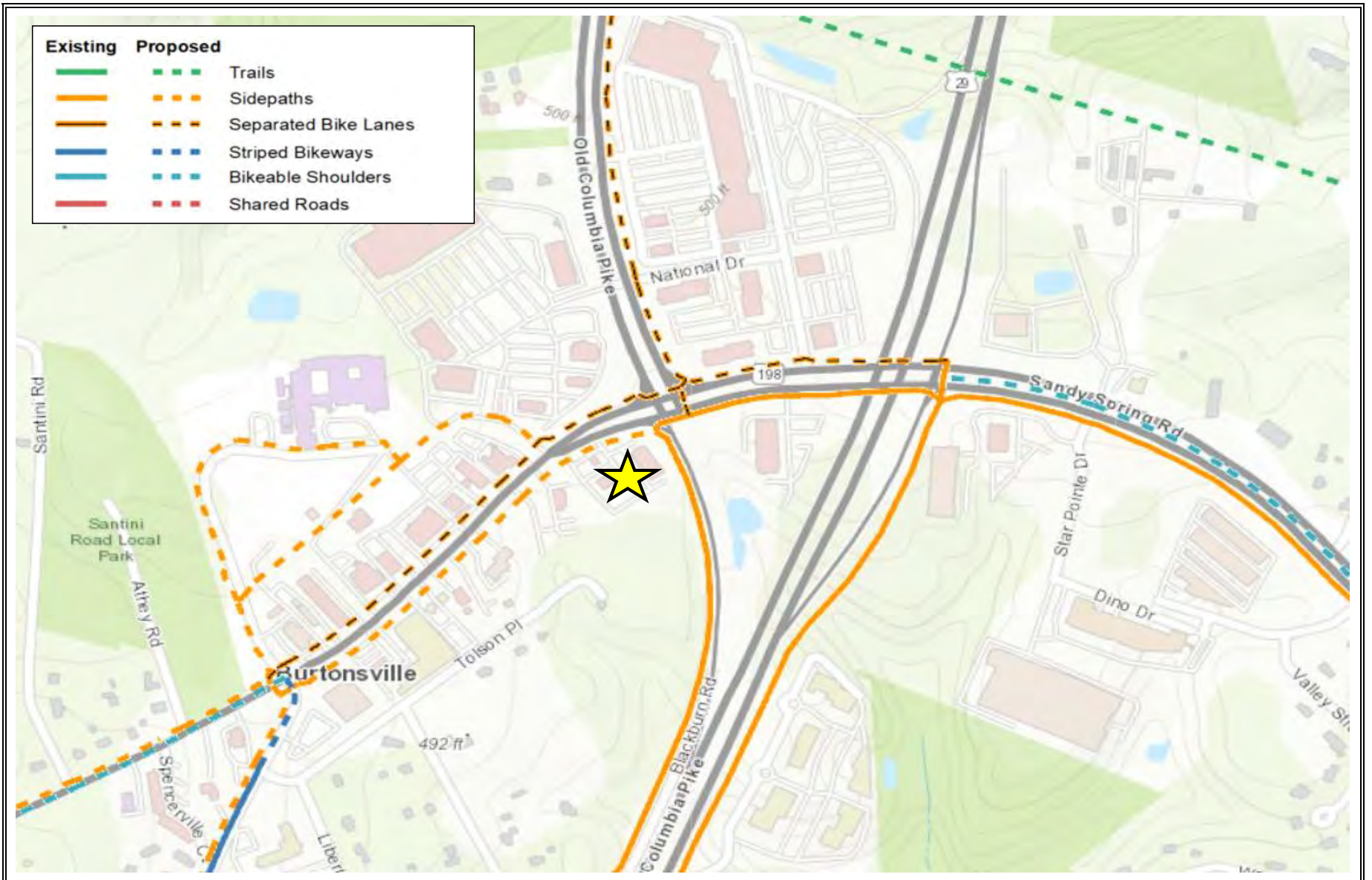

Transportation Facilities Analysis

Lenhart Traffic Consulting, Inc.
Traffic Engineering & Transportation Planning

Bicycle
Evaluation Area

**Exhibit
17**

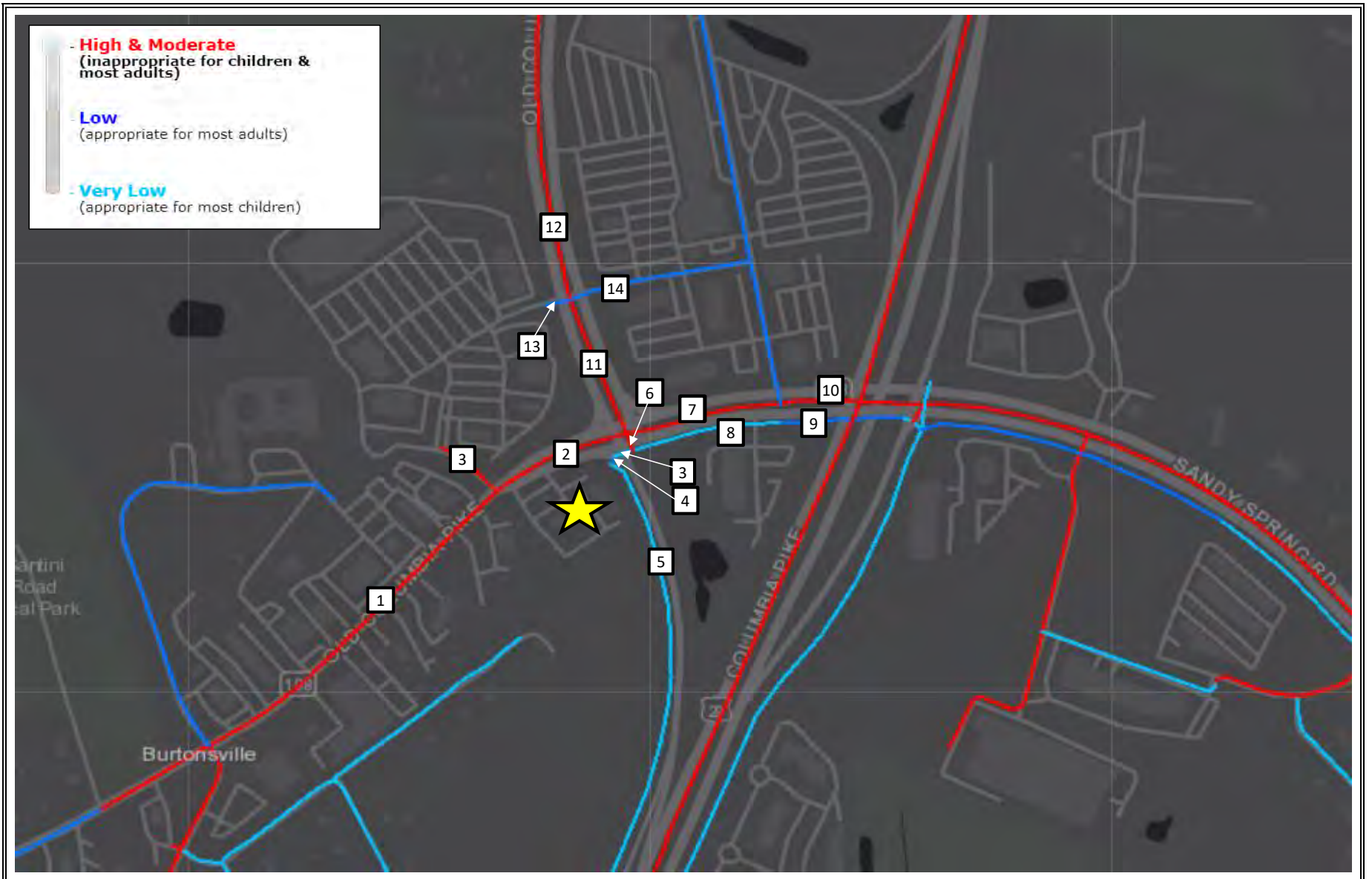

Transportation Facilities Analysis	Bicycle Evaluation Area	Exhibit 18
Lenhart Traffic Consulting, Inc. Traffic Engineering & Transportation Planning		

Segment Number	Segment	Bicycle Stress Level	Existing Bicycle Facility	Planned Bicycle Facility	Notes
1	MD 198 West of Site	High / Moderate	None	Separated Bike Lane along the north side. Sidepath along the south side.	Off-site improvements are unlikely to be constructed due to the limitations of the proportionality guide for this project.
2	MD 198 Along Site Frontage	High / Moderate	None	Separated Bike Lane along the north side. Sidepath along the south side.	The applicant is constructing a sidepath and seperated bike lane along the site frontage.
3	South side of MD 198	Very Low	Sidepath	None	The applicant is constructing a breezeway along the site frontage along US 29 ramps
4	South side of MD 198	Low	Sidepath	None	The applicant is reconstructing the southwest quadrant of the intersection of MD 198 & US 29 SB Ramps to remove the hot right turn.
5	West side of US 29 SB Ramp	Very Low	Sidepath	None	The applicant is constructing a breezeway along the site frontage along US 29 ramps
6	Old Columbia Pike at intersection with MD 198	High / Moderate	None	Separated Bike Lane	Off-site improvements are unlikely to be constructed due to the limitations of the proportionality guide for this project.
7	North side of MD 198 East of Old Columbia Pike	High / Moderate	None	Separated Bike Lane	Off-site improvements are unlikely to be constructed due to the limitations of the proportionality guide for this project.
8	South side of MD 198 East of Old Columbia Pike	Very Low	Sidepath	None	No improvements required. Adequate LTS with existing facilities.
9	South side of MD 198 East of Old Columbia Pike	Low	Sidepath	None	No improvements required. Adequate LTS with existing facilities.
10	North side of MD 198 East of National Drive	High / Moderate	None	Separated Bike Lane	Off-site improvements are unlikely to be constructed due to the limitations of the proportionality guide for this project.
11	Old Columbia Pike North of MD 198	High / Moderate	None	Separated Bike Lane	Off-site improvements are unlikely to be constructed due to the limitations of the proportionality guide for this project.
12	Old Columbia Pike North of National Drive	High / Moderate	None	Separated Bike Lane	Off-site improvements are unlikely to be constructed due to the limitations of the proportionality guide for this project.
13	National Drive West of Old Columbia Pike	Low	None	None	No improvements required. Adequate LTS with existing facilities.
14	National Drive East of Old Columbia Pike	Low	None	None	No improvements required. Adequate LTS with existing facilities.

Transportation Facilities Analysis	Bicycle Infrastructure Analysis	Exhibit 19
Lenhart Traffic Consulting, Inc. Traffic Engineering & Transportation Planning		

Section 5 Bus Transit System Adequacy

Section 5.1 – Adequacy Requirements & Study Area

Per the GIP, a Bus Transit System Adequacy analysis is required as the site will generate more than 50 peak hour person trips. Specifically, the site will generate 342 peak hour person trips during the AM peak hour and 238 peak hour person trips during the PM peak hour. Table 3 of the LATR Guidelines provides the required study area from the site frontage that is to be analyzed for bus transit system adequacy based on the peak hour person trips and is provided below. As shown, a 1,300-foot study area from the site frontage must be analyzed and up to two shelters / amenities must be constructed.

Table 3. Bus Transit Adequacy Test Scoping

Peak-Hour Person Trips Generated	Red and Orange Policy Areas	Yellow Policy Areas
50 – 99	2 shelters within 500'	1 shelter within 500'
100 – 199	2 shelters within 1,000'	2 shelters within 1,000'
200 – 349	3 shelters within 1,300'	2 shelters within 1,300'
350 or more	4 shelters within 1,500'	3 shelters within 1,500'

As detailed in the GIP, a bus stop is considered adequate if it includes a shelter outfitted with real-time travel information displays and other standard amenities.

Section 5.2 – Bus Transit System Inventory

An inventory of the bus stops in the 1,300-foot study area is detailed on **Exhibit 20**. As shown, there are two bus stop locations in the study area. Neither bus stop is equipped with shelters, benches, or real-time travel information.

Section 5.3 – Bus Transit System Recommendations

Given the limitations of the maximum cost of off-site improvements, it is recommended that pedestrian and bicycle facilities are prioritized rather than improvements to the bus transit system. However, the use of the off-site improvement budget will be coordinated with Montgomery County Staff.

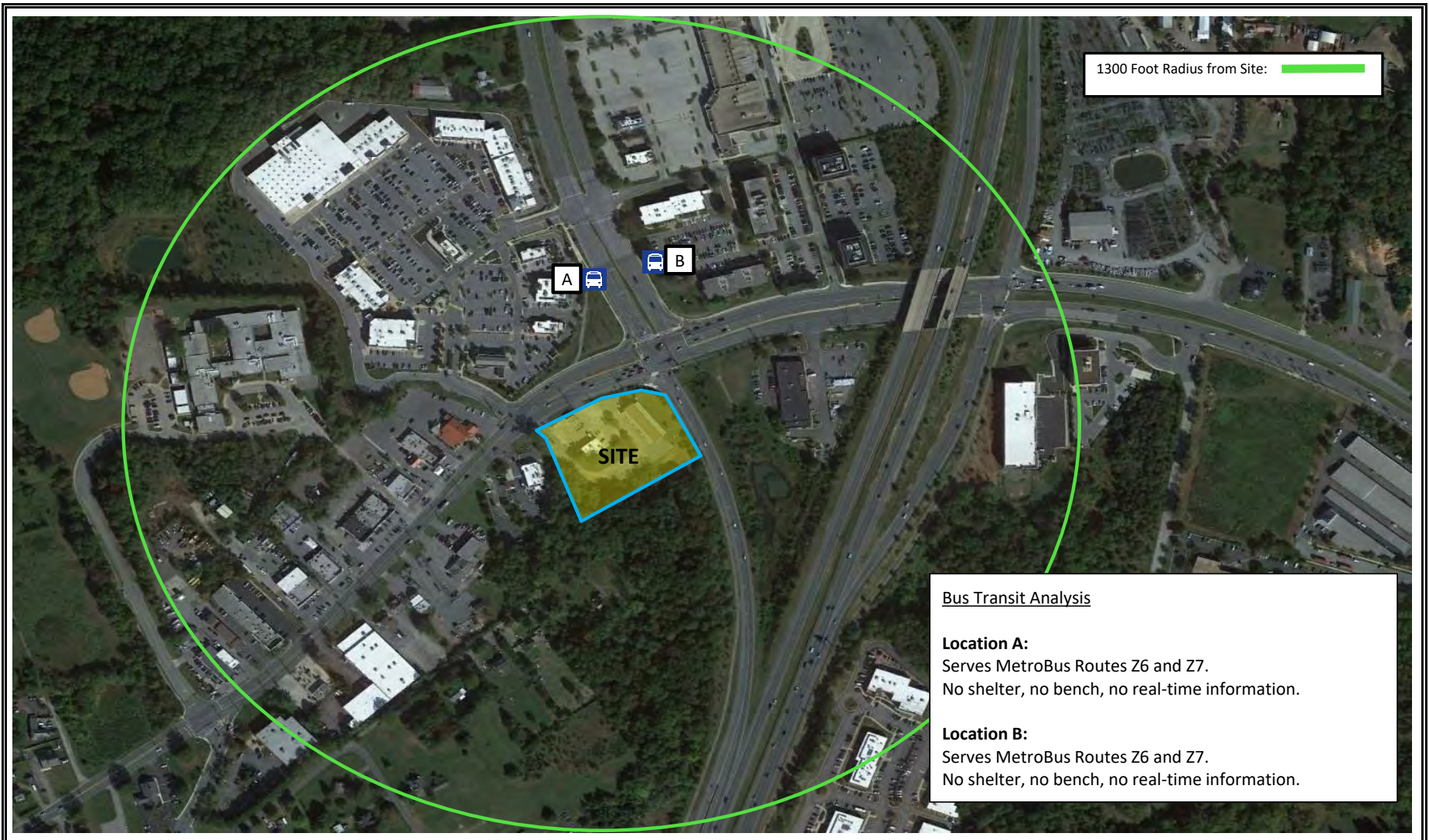

Transportation Facilities Analysis	<h2>Bus Transit System Evaluation</h2>	<h2>Exhibit 20</h2>
Lenhart Traffic Consulting, Inc. Traffic Engineering & Transportation Planning		

Section 6 Vision Zero Statement

Section 6.1 – Overview

Per the GIP, a Vision Zero Statement must be provided for the site since it generates more than 50 peak hour person trips. A Vision Zero Statement must assess and propose solutions to high injury networks and safety issues, review traffic speeds, and describe in detail how safe site access will be provided.

A review of the current High Injury Networks (HIN) per the Montgomery County Vision Zero website indicated that the portion of MD 198 within the study area is included in the MD 198 Speed Limit Reduction project, which has reduced the speed limit along MD 198 between Dino Drive and Piney Orchard Road by 5 MPH. The speed limit along MD 198 between the two intersections with Old Columbia Pike has been reduced to 25 MPH.

Section 6.2 – Safety Considerations

Crash data from 2015-2022 was obtained from Montgomery County Vision Zero Data Explorer tool to identify any severe or fatal bicycle or pedestrian crashes in the general vicinity of the site. An overview of the crash data is included on **Exhibit 21**. As shown, there are very few crashes involving bicyclists or pedestrians. In fact, these crash types combine to make up only 1.74% of all crashes in the study network. Thirteen crashes considered severe have occurred since 2015. However, the data indicates that the reduced speed limit along MD 198, specifically in the 25 MPH section, has been successful as all severe crashes except for three occurred prior to 2019, and no severe crashes have occurred in the 25 MPH section since the reduction in speed limit. Based on this data, it is recommended that MDOT SHA and/or Montgomery County consider extending the 25 MPH reduced speed limit section along MD 198.

Site Access & Circulation

The site is currently accessed along MD 198 with a full movement access on the western side of the property, opposite the Burtonsville Town Center shopping center driveway, and a right-in/right-out access approximately 125 feet east of the full movement access. The access configuration is proposed to remain unchanged with the proposed development. However, the western full movement access point is proposed to be signalized with the redevelopment, as described in greater detail in Section 2.4.

In preliminary conversations with staff during the scoping process, there has been discussion regarding the necessity of maintaining the easternmost right-in/right out site

access point. This access point is critical to the site's operation and operates safely, and it is, therefore, recommended that it be maintained with the redevelopment of the site. The following provides additional support for maintaining the eastern driveway:

- The proposed land use with the redevelopment is consistent with the existing land use, i.e. a convenience store with gas station. These types of establishments nearly always have multiple access points in order to accommodate the circulation of large fuel trucks making deliveries. In fact, a review of available aerials of nearby gas stations indicated that every station within several miles of the site had at least two access points.
- In order to understand site circulation patterns today, a 13-hour turning movement count with heavy-vehicle classification was conducted at each of the site access points on May 4, 2023. The data is included in Appendix A for reference. A summary of the findings from that data is as follows:
 - Based on the overall traffic data:
 - The vast majority of inbound traffic utilizes the western access point. Out of a total of 1,387 vehicles entering the site, 1,360 entered at the western access point.
 - Approximately 76% of outbound traffic utilizes the eastern access point. Out of 1,285 vehicles exiting the site, 984 exited at the eastern access point.
 - The above indicates a natural circulation through the site, with most traffic entering at the western access and exiting at the eastern access point. Note that all left-turns into and out of the site occurred at the western access point due to the restriction of the median along MD 198.
 - Based on the heavy vehicle traffic data:
 - The site circulation observed for heavy vehicles is consistent with overall traffic.
 - Most heavy vehicles enter at the west access. Out of 65 heavy vehicles entering the site, 63 entered at the western access point.
 - Most heavy vehicles exited at the east access. Out of 67 heavy vehicles exiting the site, 57 vehicles (or 85%) exited at the eastern access point.

Based on the above, the eastern site access operates as the primary egress for the property, with most vehicles exiting the site destined east along MD 198. Retaining the eastern access point allows the property to maintain its natural circulation pattern.

- The existing site access operates safely, as shown in the crash data from the Montgomery County Interactive Crash Map. Specifically, although the eastern site access point handles more than 75% of the site’s outbound traffic, which equates to more than 1,000 vehicles per day, the Montgomery County Interactive Crash Map does not indicate a single crash at the site access point over the course of eight years of available data, between 2015 and 2022.



Screenshot from Montgomery County Interactive Crash Map showing eight years of crash data (2015-2022). As shown, there are no crashes at the eastern site access point, circled in red, above.

- Transportation improvements proposed with the redevelopment will further enhance safety at the site access point due to changes in traffic flow along eastbound MD 198 in the vicinity of the site:
 - The proposed redevelopment includes signalization of the western full movement site access point along MD 198. A traffic signal at this location will interrupt traffic flow along MD 198, thereby creating more gaps and lower speeds for vehicles exiting at the eastern right-in/right-out access, thus enhancing the safety of the egress at this location.
 - In addition, the eastbound approach of the intersection of MD 198 & Old Columbia Pike/US 29 SB On Ramp, immediately east of the site, is proposed to be reconstructed to consist of a left-turn lane, two through lanes, and a shared through/right-turn lane. Importantly, the existing channelized right-turn to US 29 southbound is proposed to be removed with the reconstruction. This will enhance safety at the site access point in two ways:
 - First, vehicles destined from eastbound MD 198 to southbound US 29 will no longer be able to maintain a high speed through the

intersection. As such, speeds in front of the site access point are likely to be reduced.

- Second, the existing deceleration lane for the eastbound right turn onto the US 29 ramp is proposed to be removed, which will eliminate one lane that traffic leaving the eastern access point must cross today.
- With respect to speeds in the area, speed studies conducted along eastbound MD 198 near the project site show that vehicle speeds are within the 25 MPH posted speed limit, with very few vehicles exceeding 20% of the posted 25 MPH speed limit. Combined with the improvements proposed along MD 198, vehicle speeds can be expected to remain similar, or even decrease across the site frontage, thus allowing for safe egress from the site.
- The level of service analyses indicate that both site access points will operate well within the adequacy requirements of the Burtonsville Town Center Policy Area.
- Maintaining the right-in/right-out access point with the redevelopment will reduce the queue for vehicles exiting the site at the westmost access point. If the right-in/right-out access point is removed, all vehicles will be required to utilize the signalized access point, thus resulting in larger queues internal to the site, which has the potential to result in more-risky behavior for drivers exiting the site, as well as circulation issues within the site.
- Finally, if the eastern site access point were not to be permitted, the lack of this second access point would require large fuel trucks to make challenging turns within the site, and to traverse the parking lot in close proximity to pedestrians and parked passenger cars. These maneuvers would occur in highly-trafficked areas surrounding the building and/or fuel canopy, as opposed to directing large vehicles directly back out onto a roadway designed for them via a second access point. The number of pedestrians likely to be encountered during these maneuvers on site, within a busy parking lot of a convenience store with gas station is likely to be far more than the number encountered when turning out of the site, thereby creating a greater safety hazard, overall.

In short, the existing site access configuration operates safely and effectively and will continue to do so/be enhanced by proposals put forth as part of the redevelopment of the site. The existing traffic volumes show a natural site circulation between the two access points, with the west site access point primarily utilized by inbound vehicles and the eastern right-in/right-out site access primarily utilized by outbound vehicles. There is no existing crash pattern at the site access point. Based on all relevant data and considerations, this existing access pattern should be maintained with the redevelopment of the site, as discussed above.

Section 6.3 – Speed Studies

During the scoping process, M-NCPPC Staff requested speed studies at the following locations:

- MD 198, west of project site (25 MPH speed limit)
- MD 198, east of project site (35 MPH speed limit)
- Old Columbia Pike, north of National Drive (45 MPH speed limit)

Speed studies were conducted and the results are included in Appendix E. As shown in Appendix E, the speeds are generally within 20% of the posted speed limit, with the exception of vehicles along westbound MD 198, west of the project site. It should be noted, however, that the location of the speed study is nearby the transition from 35 MPH to 25 MPH in the westbound direction, and the speed studies do show a reduction in westbound speeds along MD 198 from the study conducted east of the site to the study conducted west of the site.

Note:

Small gray icons with a dark square interior represent minor crashes with no/minimal injury. Icons with a large purple square represent severe crashes.

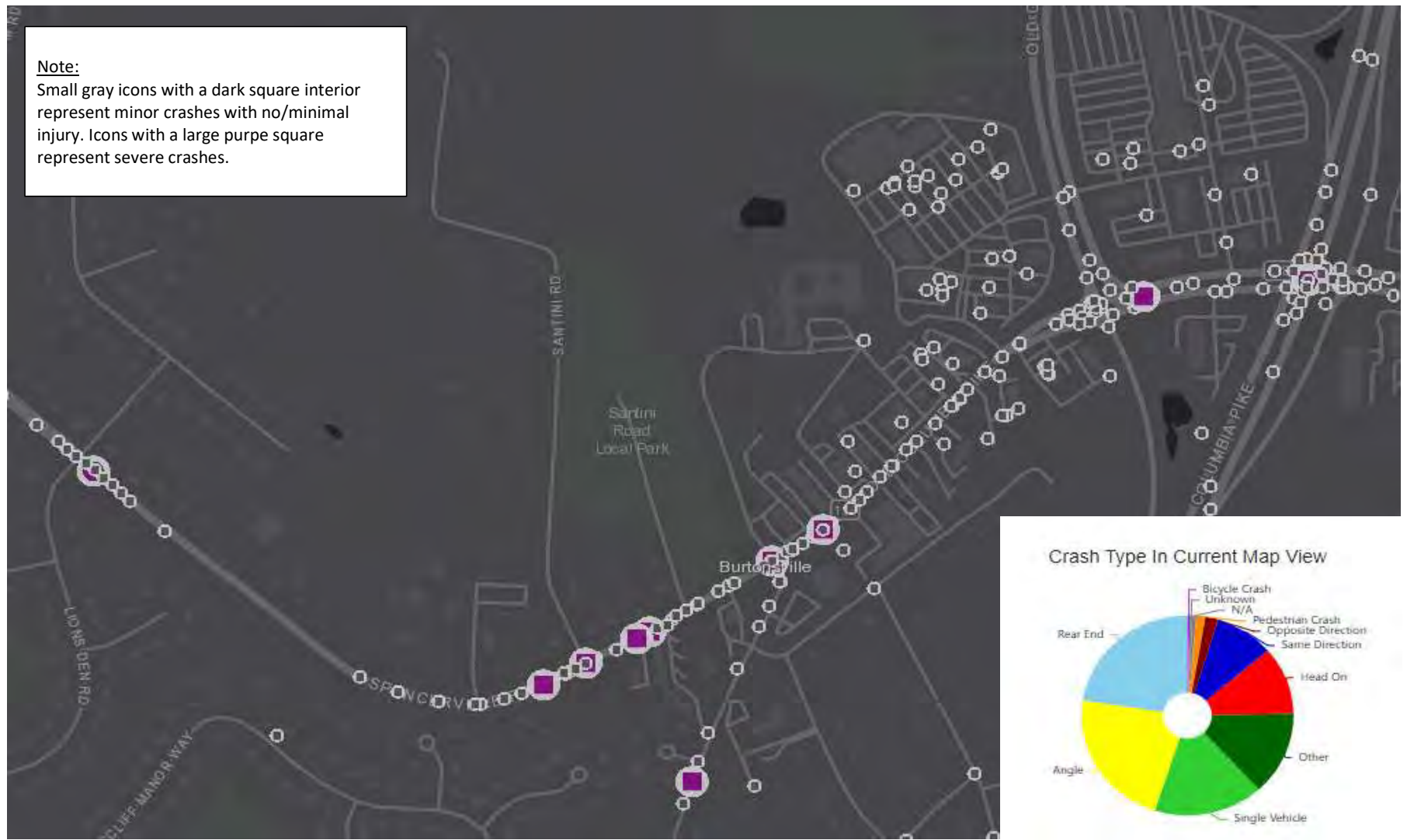

Transportation Facilities Analysis
Lenhart Traffic Consulting, Inc.
Traffic Engineering & Transportation Planning

Crash Data: 2015 - 2022
(Source: Montgomery County Interactive Crash Map)

**Exhibit
20**

Section 7 Conclusions

As detailed in this report, the conclusions and findings of this study yielded the following results:

- The redevelopment of the site will generate 342 net AM peak hour person trips and 238 net PM peak hour person trips based on the ITE Trip Generation Manual, 11th Edition and applicable Montgomery County adjustment factors.
 - The proposed redevelopment generates only 34 additional primary vehicle trips during the AM peak hour and 10 additional primary vehicle trips during the evening peak hour.
- The project has a maximum cost of offsite improvements of \$29,151.00 based on the LATR Proportionality Guide.
- The results of the Motor Vehicle Adequacy Test (Section 3) found that all of the study intersections will operate well within adequacy thresholds for the Burtonsville Town Center Policy Area.
 - The applicant is proposing significant road improvements, including removing the eastbound channelized right-turn at MD 198 & Old Columbia Pike/US 29 SB On Ramp and installing a traffic signal at the westmost site access point along MD 198.
- Based on the results of the Pedestrian, Bicycle, and Transit Adequacy Tests, the following transportation system improvements may be recommended, provided they can be accomplished within the applicant's cost cap, and pending a detailed review of feasibility:
 - Construct pedestrian system improvements at the intersection of MD 198 & Old Columbia Pike/US 29 SB On Ramp such as high-visibility crosswalks at locations with standard crossings.
 - Extend the proposed breezeway along US 29 SB On Ramp beyond the site frontage.
- The Vision Zero Statement indicates the following:
 - Crash data for the years 2015-2022 indicates the reduced speed limit along MD 198 has reduced the number of severe crashes within the study network. Speeds within the study network were generally found to be within 20% of the posted speed limit, with the exception of westbound MD 198, west of the project site. However, the speed study was conducted near the transition from 35 MPH to 25 MPH posted speed limits and the studies show that vehicle speed decreases in the westbound direction from east of the project site to west of the project site.
 - The site currently has two access points: one full movement access on the western side of the property and one right-in/right-out access. The site access configuration is proposed to be maintained with the redevelopment of the

site.

- The western full movement access is proposed to be signaled with the redevelopment of the site.
- Questions have been raised regarding the need to maintain the eastern right-in/right-out access. It is recommended that the right-in/right-out access is maintained based on the extensive discussion included in Section 6.2.

Appendix A

Supplemental Information
Turning Movement Counts





MONTGOMERY COUNTY PLANNING DEPARTMENT
THE MARYLAND-NATIONAL CAPITAL PARK AND PLANNING COMMISSION

Local Area Transportation Review

TRANSPORTATION IMPACT STUDY SCOPE OF WORK AGREEMENT

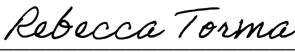
September 2021

<p>Scoping Approval - Prior to initiating a Local Area Transportation Review study or supplemental traffic study, scoping <i>must be approved</i> by relevant agencies, including the Planning Department, the Montgomery County Department of Transportation, and the State Highway Administration (where relevant). It is the responsibility of the Applicant to obtain approval, which is demonstrated below via signature or electronic signature of the relevant agency representatives. Generally, the Applicant should anticipate a turnaround time of ten (10) business days for form review. Substantially large projects may require additional time and/or may warrant a scoping meeting.</p>			
<p>Montgomery County Planning Department Name (print): <u>Chris Van Alstyne</u> Signature: <u></u> Date: <u>9/12/2023</u></p>			
<p>Montgomery County Department of Transportation Name (print): _____ Signature: <u></u> Date: _____</p>			
<p>State Highway Administration (where relevant) Name (print): <u>Kwesi Woodroffe</u> Signature: <u></u> Date: <u>9/12/2023</u></p>			
<p>Applicant Contact Information</p>			
<p>Transportation Consultant (company, contact name, email, and phone number)</p>			
<p>Name of Applicant / Developer</p>			
<p>Project Information <i>Include Tables/Graphics, As Needed</i></p>			
<p>Project Name (include plan no. if known)</p>			
<p>Project Location (include address if known)</p>			
<p>Policy Area(s) (See Growth & Infrastructure Policy Area map T1¹)</p>		<p>Master Plan(s) / Sector Plan Area(s)</p>	

¹ <https://montgomeryplanning.org/wp-content/uploads/2020/11/20210101-Text-of-the-2020-2024-Growth-and-Infrastructure-Policy-with-Maps.pdf>

Application Type(s)	<input type="checkbox"/> Preliminary Plan	<input type="checkbox"/> Site Plan	<input type="checkbox"/> Sketch/Concept/Pre-Preliminary (Optional)	<input type="checkbox"/> Amendment
	<input type="checkbox"/> Conditional Use (formerly special exception)	<input type="checkbox"/> Local Map Amendment	<input type="checkbox"/> APF at Building Permit	<input type="checkbox"/> Other:
Project Description & Previous Approvals (proposed land uses, zoning, no. of units, square footage, construction phasing, prior approvals and proposals, existing uses, site operations, year built, status of Adequate Public Facilities [APF], other relevant info)				
1.Site Access (proposed access location(s), existing/adjacent/opposite curb cuts, interparcel connections, access configurations and restrictions, internal circulation, private roads, parking/loading areas, other relevant info)				
2.Transportation Analysis Requirement	<input type="checkbox"/> Transportation Impact Study Generates <u>50 or more</u> total weekday peak-hour person trips (vehicular, transit, bicycle, and/or pedestrian) with no reductions other than a credit for existing developments over 12 years old, <u>AND</u> is outside of the White Flint and White Oak Policy Areas. Fill out remainder of this form and include in transportation impact study appendix.		<input type="checkbox"/> Transportation Impact Study Exemption Statement Generates <u>49 or fewer</u> total weekday peak-hour person trips (vehicular, transit, bicycle, and/or pedestrian) with no reductions other than a credit for existing developments over 12 years old, <u>OR</u> within White Flint and White Oak Policy Areas.	
3.Project-based Transportation Demand Management Plan Required? (see Chapter 42, Articles I and II)	<input type="checkbox"/> No	<input type="checkbox"/> Yes (In Transportation Management District [TMD])	<input type="checkbox"/> Amend Existing Project-based TDM Plan	
4.Established Transportation Management District	<input type="checkbox"/> No	<input type="checkbox"/> Yes TMD Name: _____		

(TMD)?		
Transportation Impact Study Assumptions <i>Include Tables/Graphics, As Needed</i>		
5. Study Years / Phases	Existing Year:	Phases / Build-out Year(s):
6. Study Periods	<input type="checkbox"/> AM <input type="checkbox"/> PM <input type="checkbox"/> Mid-day <input type="checkbox"/> Saturday <input type="checkbox"/> Sunday <input type="checkbox"/> Other: _____	
7. Study Intersections (For projects generating 50 or more weekday peak-hour person trips, list all signalized & significant unsignalized intersections, and site driveways traffic counts must be collected within 12 months of completed and accepted application)	# of tiers of intersections to study (refer to current LATR Guidelines): _____ <i>For the purpose of determining the number of tiers of study intersections, trip calculation for the subject site should also include nearby unbuilt properties in common ownership. No trip reductions should be taken in this calculation other than a credit for existing developments over 12 years old.</i>	
	1)	7)
	2)	8)
	3)	9)
	4)	10)
	5)	11)
	6)	attach more rows if necessary
8. Trip Generation (Clearly cite sources and methodology including use of ITE average trip rates vs. equations, ITE land use code(s); include trip generation for existing site, current approvals, proposed uses, and net changes. Show calculations in the cells to the right of this box.)	Vehicle Trips* (AM) (Auto Driver)	Total Person Trips* (AM)

	Vehicle Trips* (PM) (Auto Driver)	Total Person Trips* (PM)
	<p><i>* Only required if total peak hour person trips are 50 or more in either the AM or PM peak hour. Sum of all vehicle, transit, and non-motorized trips shall be the equivalent of total person trips. . Show all calculations for vehicle and person trips in the cells immediately above.</i></p>	
<p>9. Multi-modal Intersection Counts</p>	<p>Are new counts being collected in support of this study?*</p> <p>Are historical counts being used in support of this study?</p> <p>N/A - No Counts Required; Red Policy Area</p> <p><i>*Refer to the LATR Guidelines for the procedures pertaining to the collection of multi-modal (i.e., motor vehicle, bicycle and pedestrian) intersection counts. Generally, counts are acceptable when they are less than one year old at the time a transportation study is submitted.</i></p>	
<p>10. Trip Reductions</p> <p>(include justification and supporting documentation for internal capture, pass-by, diverted, Transportation Demand Management)</p>		
<p>11. Trip Distribution %</p> <p>(include a map of the proposed project in addition to a list or table)</p>	<p><input type="checkbox"/> A map is attached.</p>	

<p>12. Pipeline Developments to be considered as background traffic</p> <p>(include name, plan #, land uses, and sizes for approved but unbuilt developments or concurrently pending applications; info can be obtained from the M-NCPPC Pipeline website: - website is updated quarterly)</p>	
<p>13. Pipeline Transportation Projects to be considered as background condition</p> <p>(fully funded for construction in County Capital Improvement Program, State Consolidated Transportation Program, developer projects, etc. within the next 6 years)</p>	
<p>14. Vision Zero Statement</p> <p>(Include maps depicting the scope of the various Vision Zero Statement scoping requirements.)</p>	<ul style="list-style-type: none"> • Trigger: All LATR studies for a site that generates 50 or more weekday peak-hour person trips must develop a Vision Zero Statement. • Requirements: The Vision Zero Statement consists of four components: <ol style="list-style-type: none"> 1. Review High Injury Network segments: Document any segments on the High Injury Network (HIN) that are within a certain distance of the site frontage. 2. Assess proximate safety issues: Review the crash history for all segments and crossings within a certain distance of the site frontage. 3. Review traffic speeds: Conduct speed studies within a certain distance from the site frontage. 4. Describe site access: Address the safety issues identified in steps 1 through 3 and describe how site circulation promotes safety, outlining how safe access will be provided to the site. <p>The applicant should refer to the <i>LATR Guidelines</i> to determine the applicable scoping distance pertaining to steps 1 through 3 and requirements pertaining to steps 1 through 4 above.</p> <p><input type="checkbox"/> Maps are attached.</p>

Preliminary Mitigation Analysis	<i>*Refer to the LATR Guidelines for details on how to mitigate</i>
---------------------------------	---

<p>15.Vehicular Analysis</p> <p>(Include a map depicting the location of the study area intersections.)</p>	<p><input type="checkbox"/> Vehicular Analysis Anticipated (Vehicular mitigation to be determined after study)</p> <p><input type="checkbox"/> A map is attached</p> <ul style="list-style-type: none"> • TEST: The motor vehicle adequacy test will not be applied in "Red" policy areas and these areas will not be subject to LATR motor vehicle mitigation requirements. If the plan generates 50 or more net new weekday peak-hour person trips, HCM Analysis is required to be provided for all intersections analyzed in studies for: 1) "Orange" policy areas, and 2) intersections with a CLV of more than 1,350 in "Yellow" & "Green" policy areas. 3) With the exception of intersections located within "Red" policy areas, CLV analysis required for all intersections regardless of policy area. CLV assessment and signal timing worksheets are to be included in the study appendix. • MITIGATION: The applicant must mitigate its impact on vehicle delay or down to the applicable policy area standard, whichever is less.
<p>16.Pedestrian Analysis</p> <p>(Include a map depicting the scope of the applicable walkshed distance requirement.)</p>	<p><input type="checkbox"/> Pedestrian Mitigation Anticipated</p> <p><input type="checkbox"/> A map is attached</p> <ul style="list-style-type: none"> • TEST: If the plan generates 50 or more net new weekday peak hour person trips, mitigation of surrounding pedestrian conditions is required. MITIGATION: Mitigation consists of three components: (1) Pedestrian Level of Comfort (PLOC). Pedestrian system adequacy is defined by providing a "Somewhat Comfortable" or "Very Comfortable PLOC score on streets and intersections for roads classified as Primary Residential or higher within a certain walkshed from the site. (2) Street Lighting. The applicant must evaluate existing street lighting based on MCDOT standards along roadways and paths from the development within a certain walkshed from the site frontage. Where standards are not met, the applicant must upgrade the street lighting to meet the applicable standard. (3) ADA Compliance. The applicant must fix ADA noncompliance issues within a certain walkshed from the site frontage equivalent to half the walkshed specified in the required scoping distance. <p>The applicant should refer to the <i>LATR Guidelines</i> to determine the applicable scoping walkshed distance requirement for each component described above.</p> <p>Record walkshed distance here _____ feet</p>
<p>17.Bicycle Analysis</p> <p>(Include a map depicting the scope of the applicable bicycle scoping requirement.)</p>	<p><input type="checkbox"/> Bicycle Mitigation Anticipated</p> <p><input type="checkbox"/> A map is attached</p> <ul style="list-style-type: none"> • TEST: If the plan generates 50 or more net new peak hour weekday person trips, mitigation of surrounding bicycle conditions is required • MITIGATION: Required to ensure a low Level of Traffic Stress (LTS-2) on all existing transportation rights-of-way within a certain distance of the site frontage; Alternatively, the project may provide a master planned improvement that provides an equivalent improvement in the level of traffic stress for cyclists within a certain distance of the site frontage. <p>The applicant should refer to the <i>LATR Guidelines</i> to determine the applicable scoping distance requirement.</p> <p>Record scoping distance here _____ feet</p>

<p>18. Bus Transit Analysis</p> <p>(Include a map depicting the scope of the bus transit scoping requirement.)</p>	<p><input type="checkbox"/> Transit Mitigation Anticipated</p> <p><input type="checkbox"/> A map is attached</p> <ul style="list-style-type: none"> • TEST: If the plan generates 50 or more net new peak hour person trips, mitigation of surrounding transit conditions is required. Projects located within "Green" policy areas are exempt from the bus transit adequacy test. • MITIGATION: Required to ensure that there are bus shelters outfitted with realtime traveler information displays and other standard amenities, along with a safe, efficient, and accessible path between the site and a bus stop, at a certain number of bus stops within a certain distance from the site. <p>The applicant should refer to the <i>LATR Guidelines</i> to determine the applicable scoping distance requirement and the applicable number of bus shelters.</p> <p>Record scoping distance here <u>1,300</u> feet</p> <p>Record the applicable number of bus shelters here _____</p>
<p>Additional Analysis or Software Required</p>	<p><input type="checkbox"/> Queuing Analysis <input type="checkbox"/> Crash Analysis <input type="checkbox"/> VISSIM</p> <p><input type="checkbox"/> Signal Warrant Analysis <input type="checkbox"/> Synchro <input type="checkbox"/> CORSIM</p> <p><input type="checkbox"/> Weaving/Merge Analysis <input type="checkbox"/> SIDRA <input type="checkbox"/> Other _____</p>
<p>M-NCPPC Clarifications</p>	<p>Additional Assumptions & Special Circumstances for Discussion</p>
<ul style="list-style-type: none"> • Transportation impact study will comply with all other requirements of the LATR Guidelines not listed on this form. • If physical improvements are proposed as mitigation, the transportation impact study will demonstrate feasibility with regards to right-of-way and utility relocation (at a minimum). • If the development proposal significantly changes after this transportation impact study scope has been agreed to, the Applicant will work with M-NCPPC staff to amend the scope to accurately reflect the new proposal. • A receipt from MCDOT showing that the transportation impact study review fee has been paid will be provided to M-NCPPC IRC Division at the time the development application is submitted. • An electronic copy of the transportation impact study and appendices will be provided to Planning Department and MCDOT in electronic format.* <p>* At the time of this document's publication, the Planning Department is accepting plan applications electronically using the E-Plans platform: (https://montgomeryplanning.org/resources/eplans-applicant-user-guide/)</p>	

Montgomery Planning

LATR PROPORTIONALITY GUIDE CALCULATOR

Status: INCOMPLETE

Step 1: Select the Adjustment Factor Geography						
Burtonsville Town Center PA	LATR Proportionality Guide Adjustment Factor Map					
Step 2: Enter "Extent of Development" *						
Residential Uses **	Rate	Adjustment Factor	Total # of Units	# of MPDUs	Total	MPDU Share
	valid thru 6/30/2025	as of 9/26/2022				
Single-Family Detached (per unit)	\$24,151	25%			\$0	\$0
Single-Family Attached (per unit)	\$19,761	25%			\$0	\$0
Multifamily Low Rise (per unit)	\$15,366	25%			\$0	\$0
Multifamily High Rise (per unit)	\$10,976	25%			\$0	\$0
Senior Residential (per unit)	\$4,391	25%			\$0	\$0
Subtotal			0	0	\$0	\$0
Commercial Uses	Rate	Adjustment Factor	Total SF GFA			
	valid thru 6/30/2025	as of 9/26/2022				
Office (per SF GFA)	\$22.10	25%			\$0	
Retail (per SF GFA)	\$19.70	25%	5,919		\$29,151	
Private School and Daycare (per SF GFA)	\$1.80	25%			\$0	
Place of Worship (per SF GFA)	\$0.00	25%			\$0	
Other Nonresidential (per SF GFA)	\$10.95	25%			\$0	
Subtotal			5,919		\$29,151	
LATR PROPORTIONALITY GUIDE TOTAL					\$29,151	\$0

Step 3: Identify Cost of Off-Site Mitigation, Mitigation to be Constructed and Mitigation Payments						
Enter Cost of Improvements Identified through LATR Study that do not Exceed the LATR Proportionality Guide Total***						<- Enter Amount
Enter Cost of Improvements to Be Constructed ****						<- Enter Amount
Unadjusted Mitigation Payment					\$0	
Credit for MPDUs	0.0%	= MPDU share of LATR Proportionality Guide			\$0	
Mitigation Payment					\$0	

Step 4: Outputs for Staff Report						
LATR Proportionality Guide Total					\$29,151	
LATR Mitigation: Value of Improvements to Be Constructed					\$0	
LATR Mitigation: Mitigation Payment					\$0	
Value of Additional Improvements to Be Constructed					\$0	
Sum of Constructed Improvements and Mitigation Payments					\$0	

(1) For more information on the LATR Proportionality Guide, see the 2022 LATR Guidelines at: <https://montgomeryplanning.org/planning/transportation/latr-guidelines/>
 (2) Rates are to be adjusted biennially, effective July 1 of odd-numbered years.

Notes:

- * Extent of Development refers to the number of residential units and/or commercial square footage as approved by the Planning Board.
- ** Residential uses are defined in Section 52-39 of the county code.
- *** Include estimated costs for mitigation projects in order of priority and continue to do so until the total cost of the projects reaches the LATR Proportionality Guide or there are no additional projects on the list that will sum to a cost that is less than or equal to the LATR Proportionality Guide Total.
- **** Mitigation payments are only permitted if the Planning Board and MCDOT agree that constructing all or part of the required mitigation may not be practicable due to unattainable right-of-way, an existing CIP project, other operational conditions outside the applicant's control, or otherwise not considered practicable by the Planning Board and MCDOT, an applicant may meet this requirement with a mitigation payment to MCDOT that is reasonably related to MCDOT's estimated cost of constructing the required facilities.

Weekday Morning Peak Hour (6:30 am - 9:30 am)																					
Time:	US 29 Ramps Northbound					US 29 Ramps Southbound					MD 198 Eastbound					MD 198 Westbound					Total
	U-Turn	Left	Thru	Right	Peds	U-Turn	Left	Thru	Right	Peds	U-Turn	Left	Thru	Right	Peds	U-Turn	Left	Thru	Right	Peds	
6:30-6:45	0	30	0	47	0	0	0	0	0	1	0	46	137	0	0	0	0	254	19	1	533
6:45-7:00	0	46	0	55	0	0	0	0	0	1	0	32	160	0	0	0	0	273	46	1	612
7:00-7:15	0	33	0	68	0	0	0	0	0	1	0	37	159	0	0	0	0	281	37	1	615
7:15-7:30	0	49	0	64	0	0	0	0	0	1	1	65	206	0	0	0	0	292	51	1	728
7:30-7:45	0	37	0	77	0	0	0	0	0	0	1	61	233	0	0	0	0	340	50	0	799
7:45-8:00	0	45	0	75	0	0	0	0	0	0	2	65	221	0	0	0	0	327	61	0	796
8:00-8:15	0	55	0	76	0	0	0	0	0	0	4	57	238	0	0	0	0	281	55	0	766
8:15-8:30	0	30	1	71	0	0	0	0	0	0	2	73	185	0	0	0	0	236	54	0	652
8:30-8:45	0	39	0	61	0	0	0	0	0	1	2	51	190	0	0	0	0	223	47	1	613
8:45-9:00	0	41	0	95	0	0	0	0	0	1	2	48	185	0	1	0	0	247	55	0	673
9:00-9:15	0	42	0	78	0	0	0	0	0	4	4	39	169	0	0	0	0	214	54	3	600
9:15-9:30	0	47	0	69	0	0	0	0	0	1	2	49	202	0	0	0	0	219	60	0	648

Hourly Totals																					
6:30-7:30	0	158	0	234	0	0	0	0	0	4	1	180	662	0	0	0	0	1100	153	4	2496
6:45-7:45	0	165	0	264	0	0	0	0	0	3	2	195	758	0	0	0	0	1186	184	3	2760
7:00-8:00	0	164	0	284	0	0	0	0	0	2	4	228	819	0	0	0	0	1240	199	2	2942
7:15-8:15	0	186	0	292	0	0	0	0	0	1	8	248	898	0	0	0	0	1240	217	1	3091
7:30-8:30	0	167	1	299	0	0	0	0	0	0	9	256	877	0	0	0	0	1184	220	0	3013
7:45-8:45	0	169	1	283	0	0	0	0	0	1	10	246	834	0	0	0	0	1067	217	1	2829
8:00-9:00	0	165	1	303	0	0	0	0	0	2	10	229	798	0	1	0	0	987	211	1	2708
8:15-9:15	0	152	1	305	0	0	0	0	0	6	10	211	729	0	1	0	0	920	210	4	2549
8:30-9:30	0	169	0	303	0	0	0	0	0	7	10	187	746	0	1	0	0	903	216	4	2546

AM	Northbound					Southbound					Eastbound					Westbound					Total
Peak Hour	U-Turn	Left	Thru	Right	Peds	U-Turn	Left	Thru	Right	Peds	U-Turn	Left	Thru	Right	Peds	U-Turn	Left	Thru	Right	Peds	Total
7:15-8:15	0	186	0	292	0	0	0	0	0	0	8	248	898	0	0	0	0	1240	217	0	3091

Weekday Evening Peak Hour (4 pm - 7 pm)																					
Time:	US 29 Ramps Northbound					US 29 Ramps Southbound					MD 198 Eastbound					MD 198 Westbound					Total
	U-Turn	Left	Thru	Right	Peds	U-Turn	Left	Thru	Right	Peds	U-Turn	Left	Thru	Right	Peds	U-Turn	Left	Thru	Right	Peds	
4:00-4:15	0	48	0	90	1	0	0	0	0	0	2	48	273	0	0	0	0	272	164	0	897
4:15-4:30	0	61	0	93	0	0	0	0	0	0	2	57	253	0	0	0	0	261	96	0	823
4:30-4:45	0	55	0	107	0	0	0	0	0	2	6	49	277	0	0	0	0	292	108	1	894
4:45-5:00	0	60	1	137	1	0	0	0	0	0	2	55	248	0	0	0	0	265	120	0	888
5:00-5:15	0	46	2	104	0	0	0	0	0	0	4	70	271	0	0	0	0	311	123	0	931
5:15-5:30	0	70	2	108	0	0	0	0	0	1	7	75	295	0	0	0	0	255	139	0	951
5:30-5:45	0	51	0	89	0	0	0	0	0	1	2	46	298	0	0	0	0	284	158	1	928
5:45-6:00	0	61	1	135	0	0	0	0	0	1	6	59	259	0	0	0	0	277	96	1	894
6:00-6:15	0	52	1	88	1	0	0	0	0	0	1	43	274	0	0	0	0	283	59	0	801
6:15-6:30	0	55	1	91	1	0	0	0	0	1	5	63	248	0	0	0	0	240	48	0	751
6:30-6:45	0	46	0	72	2	0	0	0	0	0	8	57	224	0	0	1	0	243	52	0	703
6:45-7:00	0	72	0	121	0	0	0	0	0	1	3	47	187	0	1	0	0	224	38	1	692

Hourly Totals																					
4:00-5:00	0	224	1	427	2	0	0	0	0	2	12	209	1051	0	0	0	0	1090	488	1	3507
4:15-5:15	0	222	3	441	1	0	0	0	0	2	14	231	1049	0	0	0	0	1129	447	1	3540
4:30-5:30	0	231	5	456	1	0	0	0	0	3	19	249	1091	0	0	0	0	1123	490	1	3669
4:45-5:45	0	227	5	438	1	0	0	0	0	2	15	246	1112	0	0	0	0	1115	540	1	3702
5:00-6:00	0	228	5	436	0	0	0	0	0	3	19	250	1123	0	0	0	0	1127	516	2	3709
5:15-6:15	0	234	4	420	1	0	0	0	0	3	16	223	1126	0	0	0	0	1099	452	2	3580
5:30-6:30	0	219	3	403	2	0	0	0	0	3	14	211	1079	0	0	0	0	1084	361	2	3381
5:45-6:45	0	214	3	386	4	0	0	0	0	2	20	222	1005	0	0	1	0	1043	255	1	3156
6:00-7:00	0	225	2	372	4	0	0	0	0	2	17	210	933	0	1	1	0	990	197	1	2955

PM	Northbound					Southbound					Eastbound					Westbound					Total
Peak Hour	U-Turn	Left	Thru	Right	Peds	U-Turn	Left	Thru	Right	Peds	U-Turn	Left	Thru	Right	Peds	U-Turn	Left	Thru	Right	Peds	Total
5:00-6:00	0	228	5	436	0	0	0	0	0	3	19	250	1123	0	0	0	0	1127	516	3	3709

Peak Hour
Turning Movement Count



LENHART TRAFFIC CONSULTING, INC.
645 BALTIMORE ANNAPOLIS BLVD, SUITE 214
SEVERNA PARK, MD 21146
www.lenharttraffic.com

Intersection: MD 198 & US 29 Ramps
Weather: Clear
Count by: CountCAM - DSS
Count Day/Date: Tuesday, May 23, 2023
County: Montgomery

Weekday Morning Peak Hour (6:30 am - 9:30 am)																					
Time:	US 29 Ramps Northbound					Old Columbia Pike Southbound					MD 198 Eastbound					MD 198 Westbound					Total
	U-Turn	Left	Thru	Right	Peds	U-Turn	Left	Thru	Right	Peds	U-Turn	Left	Thru	Right	Peds	U-Turn	Left	Thru	Right	Peds	
6:30-6:45	0	0	0	0	1	0	38	14	51	0	0	18	150	22	0	1	67	192	18	0	571
6:45-7:00	0	0	0	0	0	0	58	19	63	0	0	21	128	20	1	1	57	182	42	0	591
7:00-7:15	0	0	0	0	0	0	48	18	87	1	1	12	166	27	1	2	58	216	28	0	663
7:15-7:30	0	0	0	0	2	0	81	27	98	0	1	16	173	15	0	4	61	196	40	0	712
7:30-7:45	0	0	0	0	0	0	71	20	94	0	0	16	207	29	0	8	62	249	36	0	792
7:45-8:00	0	0	0	0	0	0	64	30	99	0	1	25	211	24	0	6	62	247	38	0	807
8:00-8:15	0	0	0	0	1	0	80	21	84	0	1	28	205	29	0	6	55	223	38	0	770
8:15-8:30	0	0	0	0	0	0	78	31	70	0	2	28	175	21	1	1	65	166	25	0	662
8:30-8:45	0	0	0	0	0	0	65	26	68	0	1	20	189	27	0	4	53	164	24	0	641
8:45-9:00	0	0	0	0	2	0	80	24	84	0	2	30	126	31	1	2	53	170	30	0	632
9:00-9:15	0	0	0	0	0	0	64	27	56	0	0	17	149	23	2	4	41	181	26	0	588
9:15-9:30	0	0	0	0	0	0	71	34	51	0	2	18	161	36	0	6	36	179	32	0	626

Hourly Totals																					
6:30-7:30	0	0	0	0	3	0	225	78	299	1	2	67	617	84	2	8	243	786	128	0	2543
6:45-7:45	0	0	0	0	2	0	258	84	342	1	2	65	674	91	2	15	238	843	146	0	2763
7:00-8:00	0	0	0	0	2	0	264	95	378	1	3	69	757	95	1	20	243	908	142	0	2978
7:15-8:15	0	0	0	0	3	0	296	98	375	0	3	85	796	97	0	24	240	915	152	0	3084
7:30-8:30	0	0	0	0	1	0	293	102	347	0	4	97	798	103	1	21	244	885	137	0	3033
7:45-8:45	0	0	0	0	1	0	287	108	321	0	5	101	780	101	1	17	235	800	125	0	2882
8:00-9:00	0	0	0	0	3	0	303	102	306	0	6	106	695	108	2	13	226	723	117	0	2710
8:15-9:15	0	0	0	0	2	0	287	108	278	0	5	95	639	102	4	11	212	681	105	0	2529
8:30-9:30	0	0	0	0	2	0	280	111	259	0	5	85	625	117	3	16	183	694	112	0	2492

AM Peak Hour	Northbound					Southbound					Eastbound					Westbound					Total
7:15-8:15	0	0	0	0	3	0	296	98	375	0	3	85	796	97	0	24	240	915	152	0	3084

Weekday Evening Peak Hour (4 pm - 7 pm)																					
Time:	US 29 Ramps Northbound					Old Columbia Pike Southbound					MD 198 Eastbound					MD 198 Westbound					Total
	U-Turn	Left	Thru	Right	Peds	U-Turn	Left	Thru	Right	Peds	U-Turn	Left	Thru	Right	Peds	U-Turn	Left	Thru	Right	Peds	
4:00-4:15	0	0	0	0	2	0	108	44	75	0	0	34	197	33	0	4	51	202	35	0	783
4:15-4:30	0	0	0	0	0	0	93	48	99	0	1	36	207	26	0	6	74	206	41	1	837
4:30-4:45	0	0	0	0	1	0	94	40	88	0	0	31	221	25	0	7	70	212	44	0	832
4:45-5:00	0	0	0	0	0	0	95	39	67	2	4	29	180	29	0	13	69	204	38	0	767
5:00-5:15	0	0	0	0	0	0	102	44	99	0	3	24	226	23	0	12	77	214	45	0	869
5:15-5:30	0	0	0	0	0	0	112	49	102	0	1	25	223	26	0	9	74	206	44	0	871
5:30-5:45	0	0	0	0	0	0	111	45	120	1	0	41	230	26	1	7	64	192	48	0	884
5:45-6:00	0	0	0	0	1	0	91	34	147	0	2	31	205	20	1	10	70	212	46	0	868
6:00-6:15	0	0	0	0	1	0	99	51	187	1	0	30	204	22	0	6	56	226	43	0	924
6:15-6:30	0	0	0	0	0	0	97	36	139	0	1	26	202	28	1	5	53	189	36	0	812
6:30-6:45	0	0	0	0	1	0	92	43	102	0	1	21	183	31	1	6	60	192	42	0	773
6:45-7:00	0	0	0	0	1	0	65	33	82	0	2	16	164	23	1	5	61	174	56	0	681

Hourly Totals																					
4:00-5:00	0	0	0	0	3	0	390	171	329	2	5	130	805	113	0	30	264	824	158	1	3225
4:15-5:15	0	0	0	0	1	0	384	171	353	2	8	120	834	103	0	38	290	836	168	1	3309
4:30-5:30	0	0	0	0	1	0	403	172	356	2	8	109	850	103	0	41	290	836	171	0	3342
4:45-5:45	0	0	0	0	0	0	420	177	388	3	8	119	859	104	1	41	284	816	175	0	3395
5:00-6:00	0	0	0	0	1	0	416	172	468	1	6	121	884	95	2	38	285	824	183	0	3496
5:15-6:15	0	0	0	0	2	0	413	179	556	2	3	127	862	94	2	32	264	836	181	0	3553
5:30-6:30	0	0	0	0	2	0	398	166	593	2	3	128	841	96	3	28	243	819	173	0	3495
5:45-6:45	0	0	0	0	3	0	379	164	575	1	4	108	794	101	3	27	239	819	167	0	3384
6:00-7:00	0	0	0	0	3	0	353	163	510	1	4	93	753	104	3	22	230	781	177	0	3197

PM Peak Hour	Northbound					Southbound					Eastbound					Westbound					Total
5:15-6:15	0	0	0	0	2	0	413	179	556	2	3	127	862	94	2	32	264	836	181	2	3553

Peak Hour
Turning Movement Count

Intersection: MD 198 & US 29 Ramps
Weather: Clear
Count by: CountCAM - DSS
Count Day/Date: Tuesday, May 23, 2023
County: Montgomery



LENHART TRAFFIC CONSULTING, INC.
645 BALTIMORE ANNAPOLIS BLVD, SUITE 214
SEVERNA PARK, MD 21146
www.lenharttraffic.com

Weekday Morning Peak Hour (6:30 am - 9:30 am)																					
Time:	Old Columbia Pike Northbound					Old Columbia Pike Southbound					National Drive Eastbound					National Drive Westbound					Total
	U-Turn	Left	Thru	Right	Peds	U-Turn	Left	Thru	Right	Peds	U-Turn	Left	Thru	Right	Peds	U-Turn	Left	Thru	Right	Peds	
6:30-6:45	1	12	23	6	1	1	2	86	12	0	0	1	0	21	0	0	3	0	1	0	169
6:45-7:00	0	25	31	11	0	1	4	115	12	0	0	6	1	22	0	0	3	1	3	0	235
7:00-7:15	0	21	21	6	1	0	1	121	12	0	0	7	0	33	0	0	1	0	2	0	225
7:15-7:30	0	39	20	7	0	0	2	153	20	0	0	7	1	44	0	0	6	0	0	0	299
7:30-7:45	1	28	22	3	0	1	1	153	15	0	0	15	0	27	0	0	7	0	0	0	273
7:45-8:00	1	43	25	7	3	0	1	164	27	0	0	8	2	37	1	0	6	0	1	1	322
8:00-8:15	2	35	29	5	0	1	4	146	10	0	0	17	3	42	0	0	5	0	0	0	299
8:15-8:30	1	31	16	10	0	0	3	119	18	0	0	13	1	40	0	0	9	0	1	0	262
8:30-8:45	1	27	16	6	1	0	0	121	20	0	0	11	1	37	0	0	4	2	3	1	249
8:45-9:00	1	32	24	5	0	1	8	137	17	0	0	9	3	43	0	0	3	2	4	0	289
9:00-9:15	1	29	17	9	3	1	1	100	15	0	0	9	3	47	1	0	2	2	1	0	237
9:15-9:30	0	25	19	3	1	3	4	98	19	0	0	9	1	40	0	0	7	5	0	0	233

Hourly Totals																					
6:30-7:30	1	97	95	30	2	2	9	475	56	0	0	21	2	120	0	0	13	1	6	0	930
6:45-7:45	1	113	94	27	1	2	8	542	59	0	0	35	2	126	0	0	17	1	5	0	1033
7:00-8:00	2	131	88	23	4	1	5	591	74	0	0	37	3	141	1	0	20	0	3	1	1125
7:15-8:15	4	145	96	22	3	2	8	616	72	0	0	47	6	150	1	0	24	0	1	1	1198
7:30-8:30	5	137	92	25	3	2	9	582	70	0	0	53	6	146	1	0	27	0	2	1	1161
7:45-8:45	5	136	86	28	4	1	8	550	75	0	0	49	7	156	1	0	24	2	5	2	1139
8:00-9:00	5	125	85	26	1	2	15	523	65	0	0	50	8	162	0	0	21	4	8	1	1101
8:15-9:15	4	119	73	30	4	2	12	477	70	0	0	42	8	167	1	0	18	6	9	1	1043
8:30-9:30	3	113	76	23	5	5	13	456	71	0	0	38	8	167	1	0	16	11	8	1	1015

AM	Northbound					Southbound					Eastbound					Westbound					Total
Peak Hour	U-Turn	Left	Thru	Right	Peds	U-Turn	Left	Thru	Right	Peds	U-Turn	Left	Thru	Right	Peds	U-Turn	Left	Thru	Right	Peds	
7:15-8:15	4	145	96	22	3	2	8	616	72	1	0	47	6	150	1	0	24	0	1	1	1198

Weekday Evening Peak Hour (4 pm - 7 pm)																					
Time:	Old Columbia Pike Northbound					Old Columbia Pike Southbound					National Drive Eastbound					National Drive Westbound					Total
	U-Turn	Left	Thru	Right	Peds	U-Turn	Left	Thru	Right	Peds	U-Turn	Left	Thru	Right	Peds	U-Turn	Left	Thru	Right	Peds	
4:00-4:15	3	33	37	7	4	0	3	137	29	0	0	21	3	62	3	0	16	2	12	0	365
4:15-4:30	0	35	39	4	0	1	4	138	15	0	0	15	0	82	0	0	25	3	10	0	371
4:30-4:45	0	56	31	5	1	0	4	124	18	0	0	10	1	68	1	0	22	3	8	0	350
4:45-5:00	0	41	30	5	1	0	1	131	19	0	1	19	3	72	0	0	14	3	9	0	348
5:00-5:15	0	47	32	4	1	0	1	146	24	0	0	18	2	80	0	0	13	5	12	0	384
5:15-5:30	0	42	31	7	0	0	1	173	29	0	0	21	1	84	0	0	10	4	9	0	412
5:30-5:45	0	46	47	4	0	0	3	194	40	0	0	17	0	63	0	0	10	1	8	0	433
5:45-6:00	0	44	29	7	0	0	3	205	29	0	0	17	1	75	1	0	15	6	9	0	440
6:00-6:15	0	54	26	2	1	0	2	224	29	0	0	19	0	76	0	0	20	10	8	0	470
6:15-6:30	0	43	31	2	0	0	1	174	26	0	0	13	0	86	0	0	18	8	1	0	403
6:30-6:45	1	45	18	5	1	0	3	151	30	0	0	21	2	69	1	0	7	3	6	0	361
6:45-7:00	0	55	23	3	1	0	0	108	21	1	0	21	1	70	0	0	11	1	3	0	317

Hourly Totals																					
4:00-5:00	3	165	137	21	6	1	12	530	81	0	1	65	7	284	4	0	77	11	39	0	1444
4:15-5:15	0	179	132	18	3	1	10	539	76	0	1	62	6	302	1	0	74	14	39	0	1457
4:30-5:30	0	186	124	21	3	0	7	574	90	0	1	68	7	304	1	0	59	15	38	0	1498
4:45-5:45	0	176	140	20	2	0	6	644	112	0	1	75	6	299	0	0	47	13	38	0	1579
5:00-6:00	0	179	139	22	1	0	8	718	122	0	0	73	4	302	1	0	48	16	38	0	1671
5:15-6:15	0	186	133	20	1	0	9	796	127	0	0	74	2	298	1	0	55	21	34	0	1757
5:30-6:30	0	187	133	15	1	0	9	797	124	0	0	66	1	300	1	0	63	25	26	0	1748
5:45-6:45	1	186	104	16	2	0	9	754	114	0	0	70	3	306	2	0	60	27	24	0	1678
6:00-7:00	1	197	98	12	3	0	6	657	106	1	0	74	3	301	1	0	56	22	18	0	1556

PM	Northbound					Southbound					Eastbound					Westbound					Total
Peak Hour	U-Turn	Left	Thru	Right	Peds	U-Turn	Left	Thru	Right	Peds	U-Turn	Left	Thru	Right	Peds	U-Turn	Left	Thru	Right	Peds	
5:15-6:15	0	186	133	20	1	0	9	796	127	0	0	74	2	298	1	0	55	21	34	0	1757

Peak Hour
Turning Movement Count

Intersection: National Drive & Old Columbia Pike

Weather: Clear

Count by: CountCAM - DSS

Count Day/Date: Tuesday, May 23, 2023

County: Montgomery



LENHART TRAFFIC CONSULTING, INC.
645 BALTIMORE ANNAPOLIS BLVD, SUITE 214
SEVERNA PARK, MD 21146
www.lenharttraffic.com

Weekday Morning Peak Hour (6:30 am - 9:30 am)																					
Time:	Old Columbia Pike Northbound					Driveway Southbound					MD 198 Eastbound					MD 198 Westbound					Total
	U-Turn	Left	Thru	Right	Peds	U-Turn	Left	Thru	Right	Peds	U-Turn	Left	Thru	Right	Peds	U-Turn	Left	Thru	Right	Peds	
6:30-6:45	0	9	0	28	0	0	0	3	0	0	0	1	147	4	0	0	27	191	0	0	410
6:45-7:00	0	9	0	24	0	0	0	0	0	0	0	0	143	12	0	0	33	193	0	0	414
7:00-7:15	0	12	1	28	0	0	0	3	0	0	0	4	166	13	0	0	49	217	0	0	493
7:15-7:30	0	18	1	32	0	0	0	1	2	0	0	3	175	18	0	0	64	228	1	1	543
7:30-7:45	0	33	0	50	0	0	7	1	1	0	0	4	192	28	0	0	79	234	1	0	630
7:45-8:00	0	35	2	69	0	0	2	0	0	1	0	2	222	22	1	0	51	260	2	0	667
8:00-8:15	0	26	3	45	0	0	3	5	1	0	0	3	203	19	0	0	60	213	2	0	583
8:15-8:30	0	17	2	47	0	0	1	1	1	0	0	1	199	25	0	0	40	165	2	0	501
8:30-8:45	0	16	4	39	0	0	2	3	0	0	0	2	160	15	0	0	28	159	1	0	429
8:45-9:00	0	11	4	47	0	0	4	1	2	0	0	1	169	26	0	0	40	186	2	0	493
9:00-9:15	0	8	14	55	3	0	15	15	4	0	0	4	147	10	5	0	29	153	4	1	458
9:15-9:30	0	11	13	39	0	0	46	24	9	0	0	4	155	11	0	0	37	123	3	0	475

Hourly Totals																					
Time:	U-Turn	Left	Thru	Right	Peds	U-Turn	Left	Thru	Right	Peds	U-Turn	Left	Thru	Right	Peds	U-Turn	Left	Thru	Right	Peds	Total
6:30-7:30	0	48	2	112	0	0	0	7	2	0	0	8	631	47	0	0	173	829	1	1	1861
6:45-7:45	0	72	2	134	0	0	7	5	3	0	0	11	676	71	0	0	225	872	2	1	2081
7:00-8:00	0	98	4	179	0	0	9	5	3	1	0	13	755	81	1	0	243	939	4	1	2336
7:15-8:15	0	112	6	196	0	0	12	7	4	1	0	12	792	87	1	0	254	935	6	1	2426
7:30-8:30	0	111	7	211	0	0	13	7	3	1	0	10	816	94	1	0	230	872	7	0	2383
7:45-8:45	0	94	11	200	0	0	8	9	2	1	0	8	784	81	1	0	179	797	7	0	2182
8:00-9:00	0	70	13	178	0	0	10	10	4	0	0	7	731	85	0	0	168	723	7	0	2006
8:15-9:15	0	52	24	188	3	0	22	20	7	0	0	8	675	76	5	0	137	663	9	1	1890
8:30-9:30	0	46	35	180	3	0	67	43	15	0	0	11	631	62	5	0	134	621	10	1	1864
AM Peak Hour	Northbound					Southbound					Eastbound					Westbound					Total
7:15-8:15	0	112	6	196	0	0	12	7	4	1	0	12	792	87	1	0	254	935	6	1	2426

Weekday Evening Peak Hour (4 pm - 7 pm)																					
Time:	Old Columbia Pike Northbound					Driveway Southbound					MD 198 Eastbound					MD 198 Westbound					Total
	U-Turn	Left	Thru	Right	Peds	U-Turn	Left	Thru	Right	Peds	U-Turn	Left	Thru	Right	Peds	U-Turn	Left	Thru	Right	Peds	
4:00-4:15	0	24	2	76	0	0	14	6	5	0	0	2	196	18	0	0	66	198	2	0	609
4:15-4:30	0	24	1	73	0	0	13	7	1	0	0	0	226	17	0	0	60	226	2	0	650
4:30-4:45	0	27	2	62	0	0	9	2	3	0	0	1	216	18	0	0	67	231	1	0	639
4:45-5:00	0	13	2	76	0	0	4	0	5	0	0	1	214	23	0	0	54	199	0	0	591
5:00-5:15	0	17	2	80	0	0	7	3	3	0	0	2	207	22	0	0	52	240	4	0	639
5:15-5:30	0	12	8	91	0	0	15	5	0	0	0	8	227	23	1	0	65	221	7	0	682
5:30-5:45	0	31	2	77	0	0	19	8	2	0	0	10	211	23	0	0	60	240	7	0	690
5:45-6:00	0	14	5	73	0	0	6	5	2	1	0	1	209	19	0	0	90	229	8	0	661
6:00-6:15	0	20	3	63	0	0	5	11	2	0	0	3	214	18	0	0	145	244	5	0	733
6:15-6:30	0	18	2	70	0	0	6	5	1	1	0	0	207	20	1	0	135	254	4	0	722
6:30-6:45	0	11	0	66	0	0	2	0	1	0	0	1	152	16	0	0	85	190	0	1	524
6:45-7:00	0	13	0	52	0	0	2	3	2	0	0	2	172	16	0	0	57	191	0	0	510

Hourly Totals																					
Time:	U-Turn	Left	Thru	Right	Peds	U-Turn	Left	Thru	Right	Peds	U-Turn	Left	Thru	Right	Peds	U-Turn	Left	Thru	Right	Peds	Total
4:00-5:00	0	88	7	287	0	0	40	15	14	0	0	4	852	76	0	0	247	854	5	0	2489
4:15-5:15	0	81	7	291	0	0	33	12	12	0	0	4	863	80	0	0	233	896	7	0	2519
4:30-5:30	0	69	14	309	0	0	35	10	11	0	0	12	864	86	1	0	238	891	12	0	2552
4:45-5:45	0	73	14	324	0	0	45	16	10	0	0	21	859	91	1	0	231	900	18	0	2603
5:00-6:00	0	74	17	321	0	0	47	21	7	1	0	21	854	87	1	0	267	930	26	0	2674
5:15-6:15	0	77	18	304	0	0	45	29	6	1	0	22	861	83	1	0	360	934	27	0	2768
5:30-6:30	0	83	12	283	0	0	36	29	7	2	0	14	841	80	1	0	430	967	24	0	2809
5:45-6:45	0	63	10	272	0	0	19	21	6	2	0	5	782	73	1	0	455	917	17	1	2644
6:00-7:00	0	62	5	251	0	0	15	19	6	1	0	6	745	70	1	0	422	879	9	1	2492
PM Peak Hour	Northbound					Southbound					Eastbound					Westbound					Total
5:30-6:30	0	83	12	283	0	0	36	29	7	2	0	14	841	80	1	0	430	967	24	2	2809

Peak Hour
Turning Movement Count



LENHART TRAFFIC CONSULTING, INC.
645 BALTIMORE ANNAPOLIS BLVD, SUITE 214
SEVERNA PARK, MD 21146
www.lenharttraffic.com

Intersection: MD 198 & Old Columbia Pike
Weather: Clear
Count by: CountCAM - DSS
Count Day/Date: Tuesday, May 23, 2023
County: Montgomery

Weekday Morning Peak Hour (6:30 am - 9:30 am)																					
N/A Northbound		US 29 Ramps Southbound					Blackburn Rd Eastbound					Blackburn Rd Westbound					Total				
Time:	U-Turn	Left	Thru	Right	Peds	U-Turn	Left	Thru	Right	Peds	U-Turn	Left	Thru	Right	Peds	U-Turn	Left	Thru	Right	Peds	Total
6:30-6:45					0	0	5		0	0	0	0	0	1	0	0		5	0	0	11
6:45-7:00					0	0	9		2	2	0	0	4		0	0		3	0	1	18
7:00-7:15					0	0	11		1	2	0	0	5		0	0		10	0	0	27
7:15-7:30					0	0	9		0	1	0	0	7		0	0		13	0	0	29
7:30-7:45					0	0	13		1	0	0	0	7		0	0		16	0	0	37
7:45-8:00					0	0	16		2	1	0	0	11		0	0		11	0	0	40
8:00-8:15					0	0	14		0	1	0	0	7		0	0		13	0	0	34
8:15-8:30					0	0	18		1	1	0	0	8		0	0		9	0	0	36
8:30-8:45					0	0	19		2	0	0	0	7		0	0		9	0	0	37
8:45-9:00					0	0	14		3	1	0	0	7		0	0		3	0	0	27
9:00-9:15					0	0	18		0	3	0	0	4		0	0		11	0	0	33
9:15-9:30					0	0	16		0	1	0	0	9		0	0		10	0	0	35

Hourly Totals																					
6:30-7:30	0	0	0	0	0	0	34	0	3	5	0	0	17	0	0	0	0	31	0	1	91
6:45-7:45	0	0	0	0	0	0	42	0	4	5	0	0	23	0	0	0	0	42	0	1	117
7:00-8:00	0	0	0	0	0	0	49	0	4	4	0	0	30	0	0	0	0	50	0	0	137
7:15-8:15	0	0	0	0	0	0	52	0	3	3	0	0	32	0	0	0	0	53	0	0	143
7:30-8:30	0	0	0	0	0	0	61	0	4	3	0	0	33	0	0	0	0	49	0	0	150
7:45-8:45	0	0	0	0	0	0	67	0	5	3	0	0	33	0	0	0	0	42	0	0	150
8:00-9:00	0	0	0	0	0	0	65	0	6	3	0	0	29	0	0	0	0	34	0	0	137
8:15-9:15	0	0	0	0	0	0	69	0	6	5	0	0	26	0	0	0	0	32	0	0	138
8:30-9:30	0	0	0	0	0	0	67	0	5	5	0	0	27	0	0	0	0	33	0	0	137

AM	Northbound					Southbound					Eastbound					Westbound					Total
Peak Hour	U-Turn	Left	Thru	Right	Peds	U-Turn	Left	Thru	Right	Peds	U-Turn	Left	Thru	Right	Peds	U-Turn	Left	Thru	Right	Peds	Total
7:30-8:30	0	0	0	0	0	0	61	0	4	0	0	0	33	0	0	0	0	49	0	0	150

Weekday Evening Peak Hour (4 pm - 7 pm)																					
N/A Northbound		US 29 Ramps Southbound					Blackburn Rd Eastbound					Blackburn Rd Westbound					Total				
Time:	U-Turn	Left	Thru	Right	Peds	U-Turn	Left	Thru	Right	Peds	U-Turn	Left	Thru	Right	Peds	U-Turn	Left	Thru	Right	Peds	Total
4:00-4:15					0	0	29		3	0	0	0	22		0	0		8	0	0	62
4:15-4:30					0	0	17		5	1	0	0	13		0	0		9	0	0	44
4:30-4:45					0	0	17		4	1	0	0	7		0	0		7	0	0	35
4:45-5:00					0	0	26		0	0	0	0	10		0	0		6	0	0	42
5:00-5:15					0	0	24		7	0	0	0	7		0	0		8	0	0	46
5:15-5:30					0	0	36		5	0	0	0	7		0	0		11	0	0	59
5:30-5:45					0	0	19		8	2	0	0	9		0	0		43	0	0	79
5:45-6:00					0	0	37		20	0	0	0	6		0	0		43	0	0	106
6:00-6:15					0	0	38		16	0	0	0	6		0	0		51	0	0	111
6:15-6:30					0	0	23		29	1	0	0	12		0	0		28	0	0	92
6:30-6:45					0	0	24		7	1	0	0	4		0	0		16	0	0	51
6:45-7:00					0	0	16		1	0	0	0	5		0	0		5	0	0	27

Hourly Totals																					
4:00-5:00	0	0	0	0	0	0	89	0	12	2	0	0	52	0	0	0	0	30	0	0	185
4:15-5:15	0	0	0	0	0	0	84	0	16	2	0	0	37	0	0	0	0	30	0	0	169
4:30-5:30	0	0	0	0	0	0	103	0	16	1	0	0	31	0	0	0	0	32	0	0	183
4:45-5:45	0	0	0	0	0	0	105	0	20	2	0	0	33	0	0	0	0	68	0	0	228
5:00-6:00	0	0	0	0	0	0	116	0	40	2	0	0	29	0	0	0	0	105	0	0	292
5:15-6:15	0	0	0	0	0	0	130	0	49	2	0	0	28	0	0	0	0	148	0	0	357
5:30-6:30	0	0	0	0	0	0	117	0	73	3	0	0	33	0	0	0	0	165	0	0	391
5:45-6:45	0	0	0	0	0	0	122	0	72	2	0	0	28	0	0	0	0	138	0	0	362
6:00-7:00	0	0	0	0	0	0	101	0	53	2	0	0	27	0	0	0	0	100	0	0	283

PM	Northbound					Southbound					Eastbound					Westbound					Total
Peak Hour	U-Turn	Left	Thru	Right	Peds	U-Turn	Left	Thru	Right	Peds	U-Turn	Left	Thru	Right	Peds	U-Turn	Left	Thru	Right	Peds	Total
5:30-6:30	0	0	0	0	0	0	117	0	73	3	0	0	33	0	0	0	0	165	0	3	391

Peak Hour
Turning Movement Count

Intersection: Blackburn Rd & N/A
Weather: Clear
Count by: CountCAM - DSS
Count Day/Date: Tuesday, May 23, 2023
County: Montgomery



Weekday Morning Peak Hour (6:30 am - 9:30 am)																					
Lions Den Rd Northbound						Burtonsville Dr Southbound					MD 198 Eastbound					MD 198 Westbound					
Time:	U-Turn	Left	Thru	Right	Peds	U-Turn	Left	Thru	Right	Peds	U-Turn	Left	Thru	Right	Peds	U-Turn	Left	Thru	Right	Peds	Total
6:30-6:45	0	1	1	1	0	0	2	0	2	0	0	0	157	0	0	0	1	191	0	0	356
6:45-7:00	0	2	0	3	0	0	1	0	1	0	0	0	157	0	0	0	0	210	0	0	374
7:00-7:15	0	1	0	1	0	0	2	0	0	0	0	0	174	0	0	1	0	225	0	0	404
7:15-7:30	0	1	0	1	1	0	1	0	2	0	0	0	202	0	0	0	0	237	0	0	444
7:30-7:45	0	5	0	7	2	0	1	0	2	0	0	0	210	4	0	0	0	286	1	0	516
7:45-8:00	0	2	0	6	0	0	1	1	2	0	0	0	241	0	0	0	3	275	2	0	533
8:00-8:15	0	2	0	5	0	0	2	0	2	0	0	0	214	2	0	0	0	257	0	0	484
8:15-8:30	0	1	0	3	0	0	2	0	1	0	0	0	217	3	0	0	0	183	1	0	411
8:30-8:45	0	0	0	2	0	0	0	0	1	0	0	0	192	2	0	1	1	174	1	0	374
8:45-9:00	0	0	0	3	1	0	4	0	1	0	0	0	167	2	0	0	1	198	0	0	376
9:00-9:15	0	2	0	4	0	0	0	0	0	0	0	0	161	1	0	0	3	158	0	0	329
9:15-9:30	0	1	0	2	0	0	3	0	0	0	0	0	149	4	0	0	2	145	1	0	307

Hourly Totals																					
6:30-7:30	0	5	1	6	1	0	6	0	5	0	0	0	690	0	0	1	1	863	0	0	1579
6:45-7:45	0	9	0	12	3	0	5	0	5	0	0	0	743	4	0	1	0	958	1	0	1741
7:00-8:00	0	9	0	15	3	0	5	1	6	0	0	0	827	4	0	1	3	1023	3	0	1900
7:15-8:15	0	10	0	19	3	0	5	1	8	0	0	0	867	6	0	0	3	1055	3	0	1980
7:30-8:30	0	10	0	21	2	0	6	1	7	0	0	0	882	9	0	0	3	1001	4	0	1946
7:45-8:45	0	5	0	16	0	0	5	1	6	0	0	0	864	7	0	1	4	889	4	0	1802
8:00-9:00	0	3	0	13	1	0	8	0	5	0	0	0	790	9	0	1	2	812	2	0	1646
8:15-9:15	0	3	0	12	1	0	6	0	3	0	0	0	737	8	0	1	5	713	2	0	1491
8:30-9:30	0	3	0	11	1	0	7	0	2	0	0	0	669	9	0	1	7	675	2	0	1387

AM	Northbound					Southbound					Eastbound					Westbound					Total
Peak Hour	U-Turn	Left	Thru	Right	Peds	U-Turn	Left	Thru	Right	Peds	U-Turn	Left	Thru	Right	Peds	U-Turn	Left	Thru	Right	Peds	Total
7:15-8:15	0	10	0	19	3	0	5	1	8	0	0	0	867	6	0	0	3	1055	3	0	1980

Weekday Evening Peak Hour (4 pm - 7 pm)																					
Lions Den Rd Northbound						Burtonsville Dr Southbound					MD 198 Eastbound					MD 198 Westbound					
Time:	U-Turn	Left	Thru	Right	Peds	U-Turn	Left	Thru	Right	Peds	U-Turn	Left	Thru	Right	Peds	U-Turn	Left	Thru	Right	Peds	Total
4:00-4:15	0	2	0	0	0	0	2	0	1	0	0	1	228	1	0	0	4	214	1	0	454
4:15-4:30	0	1	0	0	0	0	2	0	0	0	0	1	233	4	0	0	2	246	0	0	489
4:30-4:45	0	2	0	3	0	0	1	0	2	0	0	2	241	2	0	0	0	266	2	0	521
4:45-5:00	0	0	0	1	1	0	0	0	1	0	0	0	229	2	0	0	2	212	5	0	452
5:00-5:15	0	2	0	2	0	0	1	1	0	0	0	2	233	1	0	0	5	264	0	0	511
5:15-5:30	0	1	0	4	0	0	0	0	1	0	0	0	231	3	2	0	3	223	0	0	466
5:30-5:45	0	0	0	1	0	0	0	0	0	0	0	0	239	2	0	0	3	282	0	0	527
5:45-6:00	0	2	0	2	2	0	1	0	0	0	0	0	223	1	0	0	0	228	3	0	460
6:00-6:15	0	1	0	7	0	0	1	0	0	0	0	1	242	4	2	0	5	261	1	0	523
6:15-6:30	0	1	0	5	0	0	0	0	0	0	0	0	201	1	0	0	9	253	2	0	472
6:30-6:45	0	1	0	2	0	0	0	0	0	0	0	1	187	0	0	0	2	218	3	0	414
6:45-7:00	0	2	0	1	0	0	1	0	0	1	0	3	171	2	0	0	4	188	3	0	375

Hourly Totals																					
4:00-5:00	0	5	0	4	1	0	5	0	4	0	0	4	931	9	0	0	8	938	8	0	1917
4:15-5:15	0	5	0	6	1	0	4	1	3	0	0	5	936	9	0	0	9	988	7	0	1974
4:30-5:30	0	5	0	10	1	0	2	1	4	0	0	4	934	8	2	0	10	965	7	0	1953
4:45-5:45	0	3	0	8	1	0	1	1	2	0	0	2	932	8	2	0	13	981	5	0	1959
5:00-6:00	0	5	0	9	2	0	2	1	1	0	0	2	926	7	2	0	11	997	3	0	1968
5:15-6:15	0	4	0	14	2	0	2	0	1	0	0	1	935	10	4	0	11	994	4	0	1982
5:30-6:30	0	4	0	15	2	0	2	0	0	0	0	1	905	8	2	0	17	1024	6	0	1986
5:45-6:45	0	5	0	16	2	0	2	0	0	0	0	2	853	6	2	0	16	960	9	0	1873
6:00-7:00	0	5	0	15	0	0	2	0	0	1	0	5	801	7	2	0	20	920	9	0	1787

PM	Northbound					Southbound					Eastbound					Westbound					Total
Peak Hour	U-Turn	Left	Thru	Right	Peds	U-Turn	Left	Thru	Right	Peds	U-Turn	Left	Thru	Right	Peds	U-Turn	Left	Thru	Right	Peds	Total
5:30-6:30	0	4	0	15	2	0	2	0	0	0	0	1	905	8	2	0	17	1024	6	0	1986

Peak Hour
Turning Movement Count

Intersection: MD 198 & Lions Den Rd
Weather: Clear
Count by: CountCAM - DSS
Count Day/Date: Tuesday, May 23, 2023
County: Montgomery



Weekday Morning Peak Hour (6:30 am - 9:30 am)																					
Time:	Old Columbia Pike Northbound					Old Columbia Pike Southbound					Greencastle Rd Eastbound					Greencastle Rd Westbound					Total
	U-Turn	Left	Thru	Right	Peds	U-Turn	Left	Thru	Right	Peds	U-Turn	Left	Thru	Right	Peds	U-Turn	Left	Thru	Right	Peds	
6:30-6:45	0	0	11	6	0	0	10	22	3	0	0	1	2	1	0	0	5	0	6	1	67
6:45-7:00	0	0	13	10	0	0	12	39	0	0	0	1	1	1	0	0	14	2	8	0	101
7:00-7:15	0	0	21	10	0	0	20	57	0	0	0	4	4	0	0	0	20	2	12	2	150
7:15-7:30	0	1	30	20	0	0	13	85	0	0	0	2	4	2	2	0	40	1	12	1	210
7:30-7:45	0	0	61	30	0	0	18	103	2	0	0	0	5	2	0	0	66	2	14	3	303
7:45-8:00	0	0	65	39	0	0	15	69	1	0	0	3	3	2	2	0	40	3	18	3	258
8:00-8:15	0	1	54	41	0	0	18	71	10	0	0	4	2	0	0	0	31	7	21	3	260
8:15-8:30	0	0	42	23	0	0	19	45	3	0	0	3	3	2	1	0	11	0	12	1	163
8:30-8:45	0	0	36	14	0	0	11	32	3	0	0	2	8	1	0	0	19	1	13	1	140
8:45-9:00	0	1	46	11	0	0	13	31	4	0	0	1	2	1	1	0	9	0	21	1	140
9:00-9:15	0	1	32	15	0	0	10	29	4	0	0	3	4	2	3	0	9	0	28	1	137
9:15-9:30	0	0	39	15	0	0	25	42	4	0	0	3	3	0	1	0	8	1	18	1	158

Hourly Totals																					
6:30-7:30	0	1	75	46	0	0	55	203	3	0	0	8	11	4	2	0	79	5	38	4	534
6:45-7:45	0	1	125	70	0	0	63	284	2	0	0	7	14	5	2	0	140	7	46	6	772
7:00-8:00	0	1	177	99	0	0	66	314	3	0	0	9	16	6	4	0	166	8	56	9	934
7:15-8:15	0	2	210	130	0	0	64	328	13	0	0	9	14	6	4	0	177	13	65	10	1045
7:30-8:30	0	1	222	133	0	0	70	288	16	0	0	10	13	6	3	0	148	12	65	10	997
7:45-8:45	0	1	197	117	0	0	63	217	17	0	0	12	16	5	3	0	101	11	64	8	832
8:00-9:00	0	2	178	89	0	0	61	179	20	0	0	10	15	4	2	0	70	8	67	6	711
8:15-9:15	0	2	156	63	0	0	53	137	14	0	0	9	17	6	5	0	48	1	74	4	589
8:30-9:30	0	2	153	55	0	0	59	134	15	0	0	9	17	4	5	0	45	2	80	4	584

AM	Northbound					Southbound					Eastbound					Westbound					Total
Peak Hour	U-Turn	Left	Thru	Right	Peds	U-Turn	Left	Thru	Right	Peds	U-Turn	Left	Thru	Right	Peds	U-Turn	Left	Thru	Right	Peds	
7:15-8:15	0	2	210	130	0	0	64	328	13	4	0	9	14	6	4	0	177	13	65	4	1045

Weekday Evening Peak Hour (4 pm - 7 pm)																					
Time:	Old Columbia Pike Northbound					Old Columbia Pike Southbound					Greencastle Rd Eastbound					Greencastle Rd Westbound					Total
	U-Turn	Left	Thru	Right	Peds	U-Turn	Left	Thru	Right	Peds	U-Turn	Left	Thru	Right	Peds	U-Turn	Left	Thru	Right	Peds	
4:00-4:15	0	3	68	9	0	0	17	50	1	0	0	3	1	3	1	0	7	1	24	0	187
4:15-4:30	0	1	62	22	0	0	20	51	2	0	0	2	4	0	0	0	7	2	27	1	200
4:30-4:45	0	1	54	13	0	0	25	51	3	0	0	2	0	1	1	0	11	2	19	0	182
4:45-5:00	0	0	75	12	0	0	21	43	0	0	0	0	1	1	0	0	13	2	39	0	207
5:00-5:15	0	0	67	13	0	0	20	60	3	0	0	1	3	0	1	0	12	3	31	1	213
5:15-5:30	0	1	85	21	0	0	26	60	5	0	1	5	2	2	0	0	10	3	35	0	256
5:30-5:45	0	2	60	24	0	0	33	64	5	0	0	7	4	1	1	0	10	2	29	2	241
5:45-6:00	0	2	75	15	0	0	33	118	7	1	0	2	3	1	0	0	15	3	24	4	298
6:00-6:15	0	2	53	15	2	0	56	171	6	0	0	2	1	1	4	0	15	3	29	1	354
6:15-6:30	0	0	51	17	0	0	40	148	7	0	0	4	2	0	3	0	15	3	27	2	314
6:30-6:45	0	0	47	8	0	0	25	78	3	0	0	2	2	1	0	0	17	4	21	1	208
6:45-7:00	0	1	47	7	0	0	25	43	5	0	0	0	2	1	0	0	21	7	25	0	184

Hourly Totals																					
4:00-5:00	0	5	259	56	0	0	83	195	6	0	0	7	6	5	2	0	38	7	109	1	779
4:15-5:15	0	2	258	60	0	0	86	205	8	0	0	5	8	2	2	0	43	9	116	2	806
4:30-5:30	0	2	281	59	0	0	92	214	11	0	1	8	6	4	2	0	46	10	124	1	861
4:45-5:45	0	3	287	70	0	0	100	227	13	0	1	13	10	4	2	0	45	10	134	3	922
5:00-6:00	0	5	287	73	0	0	112	302	20	1	1	15	12	4	2	0	47	11	119	7	1018
5:15-6:15	0	7	273	75	2	0	148	413	23	1	1	16	10	5	5	0	50	11	117	7	1164
5:30-6:30	0	6	239	71	2	0	162	501	25	1	0	15	10	3	8	0	55	11	109	9	1227
5:45-6:45	0	4	226	55	2	0	154	515	23	1	0	10	8	3	7	0	62	13	101	8	1192
6:00-7:00	0	3	198	47	2	0	146	440	21	0	0	8	7	3	7	0	68	17	102	4	1073

PM	Northbound					Southbound					Eastbound					Westbound					Total
Peak Hour	U-Turn	Left	Thru	Right	Peds	U-Turn	Left	Thru	Right	Peds	U-Turn	Left	Thru	Right	Peds	U-Turn	Left	Thru	Right	Peds	
5:30-6:30	0	6	239	71	2	0	162	501	25	1	0	15	10	3	8	0	55	11	109	1	1227

Peak Hour
Turning Movement Count

Intersection: Greencastle Rd & Old Columbia Pike
Weather: Clear
Count by: CountCAM - DSS
Count Day/Date: Tuesday, May 23, 2023
County: Montgomery



Weekday Morning Peak Hour (6:30 am - 9:30 am)																					
Time:	West Site Access Northbound					Shopping Center Southbound					MD 198 Eastbound					MD 198 Westbound					Total
	U-Turn	Left	Thru	Right	Peds	U-Turn	Left	Thru	Right	Peds	U-Turn	Left	Thru	Right	Peds	U-Turn	Left	Thru	Right	Peds	
6:30-6:45	0	0	0	1	0	0	5	0	8	1	0	10	184	11	0	0	21	218	3	0	461
6:45-7:00	0	0	0	0	0	0	3	0	9	0	0	15	150	9	0	0	22	195	7	0	410
7:00-7:15	0	0	0	5	0	0	0	0	15	0	0	16	143	14	1	0	27	263	21	0	504
7:15-7:30	0	3	0	5	1	0	7	0	15	0	0	12	185	14	0	0	19	275	9	0	544
7:30-7:45	0	1	0	3	0	0	2	0	27	0	0	17	219	12	0	0	25	335	5	0	646
7:45-8:00	0	1	0	7	2	0	1	0	25	0	0	29	215	21	0	0	12	291	15	0	617
8:00-8:15	0	2	0	2	1	0	5	3	22	0	0	35	212	12	0	0	9	295	17	0	614
8:15-8:30	0	2	0	3	0	0	4	0	24	1	0	35	222	16	0	0	7	208	15	0	536
8:30-8:45	0	2	0	4	0	0	2	1	20	0	0	23	190	9	0	0	10	220	17	0	498
8:45-9:00	0	3	0	2	0	0	0	1	20	1	0	34	204	12	1	0	8	212	16	0	512
9:00-9:15	0	4	0	3	0	0	5	0	24	1	0	31	142	14	0	0	15	203	25	0	466
9:15-9:30	0	2	0	4	4	0	3	1	28	0	0	39	212	17	0	0	12	180	16	0	514

Hourly Totals																					
Time:	Northbound					Southbound					Eastbound					Westbound					Total
	U-Turn	Left	Thru	Right	Peds	U-Turn	Left	Thru	Right	Peds	U-Turn	Left	Thru	Right	Peds	U-Turn	Left	Thru	Right	Peds	
6:30-7:30	0	3	0	11	1	0	15	0	47	1	0	53	662	48	1	0	89	951	40	0	1922
6:45-7:45	0	4	0	13	1	0	12	0	66	0	0	60	697	49	1	0	93	1068	42	0	2106
7:00-8:00	0	5	0	20	3	0	10	0	82	0	0	74	762	61	1	0	83	1164	50	0	2315
7:15-8:15	0	7	0	17	4	0	15	3	89	0	0	93	831	59	0	0	65	1196	46	0	2425
7:30-8:30	0	6	0	15	3	0	12	3	98	1	0	116	868	61	0	0	53	1129	52	0	2417
7:45-8:45	0	7	0	16	3	0	12	4	91	1	0	122	839	58	0	0	38	1014	64	0	2269
8:00-9:00	0	9	0	11	1	0	11	5	86	2	0	127	828	49	1	0	34	935	65	0	2164
8:15-9:15	0	11	0	12	0	0	11	2	88	3	0	123	758	51	1	0	40	843	73	0	2016
8:30-9:30	0	11	0	13	4	0	10	3	92	2	0	127	748	52	1	0	45	815	74	0	1997
AM Peak Hour	Northbound					Southbound					Eastbound					Westbound					Total
7:15-8:15	0	7	0	17	4	0	15	3	89	0	0	93	831	59	0	0	65	1196	46	0	2425

Weekday Evening Peak Hour (4 pm - 7 pm)																					
Time:	West Site Access Northbound					Shopping Center Southbound					MD 198 Eastbound					MD 198 Westbound					Total
	U-Turn	Left	Thru	Right	Peds	U-Turn	Left	Thru	Right	Peds	U-Turn	Left	Thru	Right	Peds	U-Turn	Left	Thru	Right	Peds	
4:00-4:15	0	3	1	2	0	0	4	2	41	0	0	58	263	13	0	0	21	277	38	0	723
4:15-4:30	0	2	0	4	1	0	8	2	45	4	0	33	263	10	0	0	11	245	30	0	653
4:30-4:45	0	0	1	6	1	0	10	1	45	0	0	32	249	11	0	0	12	256	36	0	659
4:45-5:00	0	2	0	3	0	0	12	1	46	0	0	44	234	13	0	0	7	264	36	0	662
5:00-5:15	0	1	0	4	0	0	8	3	50	0	0	42	264	13	0	0	12	291	26	0	714
5:15-5:30	0	2	0	2	0	0	7	2	44	0	0	30	233	11	0	0	13	290	36	0	670
5:30-5:45	0	0	1	6	0	0	5	3	39	3	0	37	262	13	0	0	18	289	29	1	702
5:45-6:00	0	3	0	1	0	0	5	1	47	0	0	55	255	10	0	0	9	291	36	0	713
6:00-6:15	0	0	0	4	0	0	6	0	47	1	0	41	243	19	0	0	12	249	44	0	665
6:15-6:30	0	1	1	5	1	0	5	2	50	0	0	42	218	12	0	0	11	222	24	0	593
6:30-6:45	0	5	1	2	1	0	7	4	54	0	0	44	210	9	0	0	10	218	37	0	601
6:45-7:00	0	0	2	4	2	0	11	2	54	0	0	35	193	10	0	0	5	209	25	0	550

Hourly Totals																					
Time:	Northbound					Southbound					Eastbound					Westbound					Total
	U-Turn	Left	Thru	Right	Peds	U-Turn	Left	Thru	Right	Peds	U-Turn	Left	Thru	Right	Peds	U-Turn	Left	Thru	Right	Peds	
4:00-5:00	0	7	2	15	2	0	34	6	177	4	0	167	1009	47	0	0	51	1042	140	0	2703
4:15-5:15	0	5	1	17	2	0	38	7	186	4	0	151	1010	47	0	0	42	1056	128	0	2694
4:30-5:30	0	5	1	15	1	0	37	7	185	0	0	148	980	48	0	0	44	1101	134	0	2706
4:45-5:45	0	5	1	15	0	0	32	9	179	3	0	153	993	50	0	0	50	1134	127	1	2752
5:00-6:00	0	6	1	13	0	0	25	9	180	3	0	164	1014	47	0	0	52	1161	127	1	2803
5:15-6:15	0	5	1	13	0	0	23	6	177	4	0	163	993	53	0	0	52	1119	145	1	2755
5:30-6:30	0	4	2	16	1	0	21	6	183	4	0	175	978	54	0	0	50	1051	133	1	2679
5:45-6:45	0	9	2	12	2	0	23	7	198	1	0	182	926	50	0	0	42	980	141	0	2575
6:00-7:00	0	6	4	15	4	0	29	8	205	1	0	162	864	50	0	0	38	898	130	0	2414
PM Peak Hour	Northbound					Southbound					Eastbound					Westbound					Total
5:00-6:00	0	6	1	13	0	0	25	9	180	3	0	164	1014	47	0	0	52	1161	127	3	2803

Peak Hour
Turning Movement Count



Intersection: MD 198 & West Site Access
Weather: Clear
Count by: CountCAM - DSS
Count Day/Date: Thursday, May 4, 2023
County: Montgomery

Weekday Morning Peak Hour (6:30 am - 9:30 am)																					
Time:	East Site Access Northbound					N/A Southbound					MD 198 Eastbound					MD 198 Westbound					Total
	U-Turn	Left	Thru	Right	Peds	U-Turn	Left	Thru	Right	Peds	U-Turn	Left	Thru	Right	Peds	U-Turn	Left	Thru	Right	Peds	
6:30-6:45	0	0	0	19	0	0	0	0	0	1	0	0	213	0	0	0	0	243	0	0	475
6:45-7:00	0	0	0	22	0	0	0	0	0	0	0	0	159	0	0	0	0	222	0	1	403
7:00-7:15	0	0	0	34	0	0	0	0	0	0	0	0	160	0	0	0	0	304	0	1	498
7:15-7:30	0	0	0	15	0	0	0	0	0	0	0	0	200	1	0	0	0	299	0	0	515
7:30-7:45	0	0	0	25	0	0	0	0	0	0	0	0	237	0	0	0	0	367	0	0	629
7:45-8:00	0	0	0	21	0	0	0	0	0	0	0	0	235	0	0	0	0	322	0	0	578
8:00-8:15	0	0	0	20	0	0	0	0	0	0	0	0	227	1	0	0	0	319	0	0	567
8:15-8:30	0	0	0	28	0	0	0	0	0	1	0	0	234	1	0	0	0	236	0	0	499
8:30-8:45	0	0	0	16	0	0	0	0	0	0	0	0	204	0	0	0	0	244	0	0	464
8:45-9:00	0	0	0	10	0	0	0	0	0	0	0	0	217	0	0	0	0	239	0	0	466
9:00-9:15	0	0	0	20	1	0	0	0	0	0	0	0	152	0	0	0	0	244	0	0	416
9:15-9:30	0	0	0	23	0	0	0	0	0	3	0	0	222	1	0	0	0	206	0	0	452

Hourly Totals																					
Time:	U-Turn	Left	Thru	Right	Peds	U-Turn	Left	Thru	Right	Peds	U-Turn	Left	Thru	Right	Peds	U-Turn	Left	Thru	Right	Peds	Total
6:30-7:30	0	0	0	90	0	0	0	0	0	1	0	0	732	1	0	0	0	1068	0	2	1894
6:45-7:45	0	0	0	96	0	0	0	0	0	0	0	0	756	1	0	0	0	1192	0	2	2047
7:00-8:00	0	0	0	95	0	0	0	0	0	0	0	0	832	1	0	0	0	1292	0	1	2221
7:15-8:15	0	0	0	81	0	0	0	0	0	0	0	0	899	2	0	0	0	1307	0	0	2289
7:30-8:30	0	0	0	94	0	0	0	0	0	1	0	0	933	2	0	0	0	1244	0	0	2274
7:45-8:45	0	0	0	85	0	0	0	0	0	1	0	0	900	2	0	0	0	1121	0	0	2109
8:00-9:00	0	0	0	74	0	0	0	0	0	1	0	0	882	2	0	0	0	1038	0	0	1997
8:15-9:15	0	0	0	74	1	0	0	0	0	1	0	0	807	1	0	0	0	963	0	0	1847
8:30-9:30	0	0	0	69	1	0	0	0	0	3	0	0	795	1	0	0	0	933	0	0	1802

AM	Northbound					Southbound					Eastbound					Westbound					Total
Peak Hour	U-Turn	Left	Thru	Right	Peds	U-Turn	Left	Thru	Right	Peds	U-Turn	Left	Thru	Right	Peds	U-Turn	Left	Thru	Right	Peds	
7:15-8:15	0	0	0	81	0	0	0	0	0	0	0	0	899	2	0	0	0	1307	0	0	2289

Weekday Evening Peak Hour (4 pm - 7 pm)																					
Time:	East Site Access Northbound					N/A Southbound					MD 198 Eastbound					MD 198 Westbound					Total
	U-Turn	Left	Thru	Right	Peds	U-Turn	Left	Thru	Right	Peds	U-Turn	Left	Thru	Right	Peds	U-Turn	Left	Thru	Right	Peds	
4:00-4:15	0	0	0	28	0	0	0	0	0	0	0	0	276	1	0	0	1	336	0	1	642
4:15-4:30	0	0	0	21	0	0	0	0	0	2	0	0	280	1	0	0	0	289	0	0	591
4:30-4:45	0	0	0	24	1	0	0	0	0	0	0	0	266	0	0	0	0	303	0	0	593
4:45-5:00	0	0	0	16	0	0	0	0	0	0	0	0	252	0	0	0	0	309	0	0	577
5:00-5:15	0	0	0	19	0	0	0	0	0	0	0	0	281	0	0	0	0	330	0	0	630
5:15-5:30	0	0	0	25	0	0	0	0	0	0	0	0	246	1	1	0	0	336	0	0	608
5:30-5:45	0	0	0	23	0	0	0	0	0	3	0	0	279	0	1	0	0	336	0	1	638
5:45-6:00	0	0	0	19	0	0	0	0	0	0	0	0	261	1	0	0	0	335	0	0	616
6:00-6:15	0	0	0	25	0	0	0	0	0	0	0	0	254	0	0	0	0	305	0	0	584
6:15-6:30	0	0	0	19	0	0	0	0	0	0	0	0	233	1	0	0	0	257	0	0	510
6:30-6:45	0	0	0	13	0	0	0	0	0	0	0	0	218	0	0	0	0	263	0	0	494
6:45-7:00	0	0	0	18	0	0	0	0	0	0	0	0	206	0	0	0	0	244	0	0	468

Hourly Totals																					
Time:	U-Turn	Left	Thru	Right	Peds	U-Turn	Left	Thru	Right	Peds	U-Turn	Left	Thru	Right	Peds	U-Turn	Left	Thru	Right	Peds	Total
4:00-5:00	0	0	0	89	1	0	0	0	0	2	0	0	1074	2	0	0	1	1237	0	1	2407
4:15-5:15	0	0	0	80	1	0	0	0	0	2	0	0	1079	1	0	0	0	1231	0	0	2394
4:30-5:30	0	0	0	84	1	0	0	0	0	0	0	0	1045	1	1	0	0	1278	0	0	2410
4:45-5:45	0	0	0	83	0	0	0	0	0	3	0	0	1058	1	2	0	0	1311	0	1	2459
5:00-6:00	0	0	0	86	0	0	0	0	0	3	0	0	1067	2	2	0	0	1337	0	1	2498
5:15-6:15	0	0	0	92	0	0	0	0	0	3	0	0	1040	2	2	0	0	1312	0	1	2452
5:30-6:30	0	0	0	86	0	0	0	0	0	3	0	0	1027	2	1	0	0	1233	0	1	2353
5:45-6:45	0	0	0	76	0	0	0	0	0	0	0	0	966	2	0	0	0	1160	0	0	2204
6:00-7:00	0	0	0	75	0	0	0	0	0	0	0	0	911	1	0	0	0	1069	0	0	2056

PM	Northbound					Southbound					Eastbound					Westbound					Total
Peak Hour	U-Turn	Left	Thru	Right	Peds	U-Turn	Left	Thru	Right	Peds	U-Turn	Left	Thru	Right	Peds	U-Turn	Left	Thru	Right	Peds	
5:00-6:00	0	0	0	86	0	0	0	0	0	3	0	0	1067	2	2	0	0	1337	0	3	2498

Peak Hour
Turning Movement Count



LENHART TRAFFIC CONSULTING, INC.
645 BALTIMORE ANNAPOLIS BLVD, SUITE 214
SEVERNA PARK, MD 21146
www.lenharttraffic.com

Intersection: MD 198 & East Site Access
Weather: Clear
Count by: CountCAM - DSS
Count Day/Date: Thursday, May 4, 2023
County: Montgomery

13-Hour Turning Movement Count (6:00 am - 7:00 pm)

Time:	West Site Access Northbound				Shopping Center Access Southbound				MD 198 Eastbound				MD 198 Westbound				Total
	Left	Thru	Right	Peds	Left	Thru	Right	Peds	Left	Thru	Right	Peds	Left	Thru	Right	Peds	
6:00-6:15	0	0	2	1	1	0	6	0	8	101	17	0	15	140	7	1	299
6:15-6:30	1	0	1	4	1	0	10	0	12	116	14	0	21	133	5	0	318
6:30-6:45	0	0	1	0	5	0	8	1	10	184	11	0	21	218	3	0	462
6:45-7:00	0	0	0	0	3	0	9	0	15	150	9	0	22	195	7	0	410
7:00-7:15	0	0	5	0	0	0	15	0	16	143	14	1	27	263	21	0	505
7:15-7:30	3	0	5	1	7	0	15	0	12	185	14	0	19	275	9	0	545
7:30-7:45	1	0	3	0	2	0	27	0	17	219	12	0	25	335	5	0	646
7:45-8:00	1	0	7	2	1	0	25	0	29	215	21	0	12	291	15	0	619
8:00-8:15	2	0	2	1	5	3	22	0	35	212	12	0	9	295	17	0	615
8:15-8:30	2	0	3	0	4	0	24	1	35	222	16	0	7	208	15	0	537
8:30-8:45	2	0	4	0	2	1	20	0	23	190	9	0	10	220	17	0	498
8:45-9:00	3	0	2	0	0	1	20	1	34	204	12	1	8	212	16	0	514
9:00-9:15	4	0	3	0	5	0	24	1	31	142	14	0	15	203	25	0	467
9:15-9:30	2	0	4	4	3	1	28	0	39	212	17	0	12	180	16	0	518
9:30-9:45	2	1	3	0	0	0	30	0	30	197	11	0	8	169	15	0	466
9:45-10:00	3	0	0	0	5	1	21	0	38	160	9	0	10	140	21	0	408
10:00-10:15	3	0	4	1	4	1	19	1	32	125	10	0	10	141	16	1	368
10:15-10:30	2	1	1	0	5	2	29	0	32	148	9	0	6	122	21	0	378
10:30-10:45	2	0	5	0	3	2	35	0	33	130	12	0	11	134	23	1	391
10:45-11:00	2	0	2	1	6	2	28	0	29	139	7	0	10	120	21	0	367
11:00-11:15	3	0	4	5	3	2	24	0	24	133	12	0	14	140	33	0	397
11:15-11:30	4	0	4	0	4	1	40	0	42	139	11	0	12	120	37	0	414
11:30-11:45	2	0	5	0	2	1	41	0	37	147	16	0	14	136	29	0	430
11:45-12:00	0	0	3	2	11	0	38	0	49	135	10	0	10	136	29	0	423
12:00-12:15	3	0	4	0	10	1	50	0	48	168	12	0	12	143	32	0	483
12:15-12:30	2	0	6	1	5	1	43	1	33	148	12	0	16	148	34	0	450
12:30-12:45	0	0	4	1	4	2	36	1	39	154	8	0	9	158	41	0	457
12:45-1:00	4	3	4	0	12	3	38	0	43	169	21	0	11	139	49	0	496
1:00-1:15	1	1	6	0	6	0	50	0	43	164	9	0	20	158	39	0	497
1:15-1:30	4	0	7	0	5	1	33	1	41	158	15	0	9	172	18	0	464
1:30-1:45	4	1	2	1	8	1	44	1	31	167	12	1	7	154	39	0	473
1:45-2:00	0	0	3	1	5	1	38	2	26	141	7	2	10	144	34	0	414
2:00-2:15	1	1	5	0	6	5	49	1	30	146	7	0	14	167	32	0	464
2:15-2:30	2	1	2	0	5	3	44	2	40	153	13	0	11	183	19	0	478
2:30-2:45	2	4	6	1	13	1	30	2	31	179	11	0	14	208	25	0	527
2:45-3:00	1	0	4	0	3	3	33	0	36	216	16	1	9	214	30	0	566
3:00-3:15	3	0	4	1	3	2	38	0	32	208	12	0	15	221	31	0	570
3:15-3:30	0	0	6	1	7	2	40	0	34	242	9	0	15	237	26	0	619
3:30-3:45	0	1	4	1	3	0	28	3	46	225	8	0	11	228	39	0	597
3:45-4:00	4	0	3	0	4	1	52	0	48	286	12	0	13	216	27	0	666
4:00-4:15	3	1	2	0	4	2	41	0	58	263	13	0	21	277	38	0	723
4:15-4:30	2	0	4	1	8	2	45	4	33	263	10	0	11	245	30	0	658
4:30-4:45	0	1	6	1	10	1	45	0	32	249	11	0	12	256	36	0	660
4:45-5:00	2	0	3	0	12	1	46	0	44	234	13	0	7	264	36	0	662
5:00-5:15	1	0	4	0	8	3	50	0	42	264	13	0	12	291	26	0	714
5:15-5:30	2	0	2	0	7	2	44	0	30	233	11	0	13	290	36	0	670
5:30-5:45	0	1	6	0	5	3	39	3	37	262	13	0	18	289	29	1	706
5:45-6:00	3	0	1	0	5	1	47	0	55	255	10	0	9	291	36	0	713
6:00-6:15	0	0	4	0	6	0	47	1	41	243	19	0	12	249	44	0	666
6:15-6:30	1	1	5	1	5	2	50	0	42	218	12	0	11	222	24	0	594
6:30-6:45	5	1	2	1	7	4	54	0	44	210	9	0	10	218	37	0	602
6:45-7:00	0	2	4	2	11	2	54	0	35	193	10	0	5	209	25	0	552

	West Site Access Northbound				Shopping Center Access Southbound				MD 198 Eastbound				MD 198 Westbound				Total
	Left	Thru	Right	Peds	Left	Thru	Right	Peds	Left	Thru	Right	Peds	Left	Thru	Right	Peds	
Hourly Totals																	
6:00-7:00	1	0	4	5	10	0	33	1	45	551	51	0	79	686	22	1	1489
7:00-8:00	5	0	20	3	10	0	82	0	74	762	61	1	83	1164	50	0	2315
8:00-9:00	9	0	11	1	11	5	86	2	127	828	49	1	34	935	65	0	2164
9:00-10:00	11	1	10	4	13	2	103	1	138	711	51	0	45	692	77	0	1859
10:00-11:00	9	1	12	2	18	7	111	1	126	542	38	0	37	517	81	2	1504
11:00-12:00	9	0	16	7	20	4	143	0	152	554	49	0	50	532	128	0	1664
12:00-1:00	9	3	18	2	31	7	167	2	163	639	53	0	48	588	156	0	1886
1:00-2:00	9	2	18	2	24	3	165	4	141	630	43	3	46	628	130	0	1848
2:00-3:00	6	6	17	1	27	12	156	5	137	694	47	1	48	772	106	0	2035
3:00-4:00	7	1	17	3	17	5	158	3	160	961	41	0	54	902	123	0	2452
4:00-5:00	7	2	15	2	34	6	177	4	167	1009	47	0	51	1042	140	0	2703
5:00-6:00	6	1	13	0	25	9	180	3	164	1014	47	0	52	1161	127	1	2803
6:00-7:00	6	4	15	4	29	8	205	1	162	864	50	0	38	898	130	0	2414

Peak Hour
Turning Movement Count

Intersection: MD 198 & West Site Access/Shopping Center Access

Weather: Clear

Count by: Count Cam

Count Day/Date: Wednesday, May 4, 2022

County: Montgomery



LENHART TRAFFIC CONSULTING, INC.
645 BALTIMORE ANNAPOLIS BLVD, SUITE 214
SEVERNA PARK, MD 21146
www.lenharttraffic.com

13-Hour Turning Movement Count (6:00 am - 7:00 pm)

Time:	East Site Access Northbound				N/A Southbound				MD 198 Eastbound				MD 198 Westbound				Total
	Left	Thru	Right	Peds	Left	Thru	Right	Peds	Left	Thru	Right	Peds	Left	Thru	Right	Peds	
6:00-6:15	0	0	25	0	0	0	0	1	0	108	0	1	0	161	0	0	296
6:15-6:30	0	0	20	1	0	0	0	0	0	131	0	0	0	160	0	1	313
6:30-6:45	0	0	19	0	0	0	0	1	0	213	0	0	0	243	0	0	476
6:45-7:00	0	0	22	0	0	0	0	0	0	159	0	0	0	222	0	1	404
7:00-7:15	0	0	34	0	0	0	0	0	0	160	0	0	0	304	0	1	499
7:15-7:30	0	0	15	0	0	0	0	0	0	200	1	0	0	299	0	0	515
7:30-7:45	0	0	25	0	0	0	0	0	0	237	0	0	0	367	0	0	629
7:45-8:00	0	0	21	0	0	0	0	0	0	235	0	0	0	322	0	0	578
8:00-8:15	0	0	20	0	0	0	0	0	0	227	1	0	0	319	0	0	567
8:15-8:30	0	0	28	0	0	0	0	1	0	234	1	0	0	236	0	0	500
8:30-8:45	0	0	16	0	0	0	0	0	0	204	0	0	0	244	0	0	464
8:45-9:00	0	0	10	0	0	0	0	0	0	217	0	0	0	239	0	0	466
9:00-9:15	0	0	20	1	0	0	0	0	0	152	0	0	0	244	0	0	417
9:15-9:30	0	0	23	0	0	0	0	3	0	222	1	0	0	206	0	0	455
9:30-9:45	0	0	13	0	0	0	0	0	0	200	0	0	0	194	0	4	411
9:45-10:00	0	0	16	0	0	0	0	1	0	170	0	0	0	171	0	0	358
10:00-10:15	0	0	14	0	0	0	0	0	0	132	3	2	0	166	0	0	317
10:15-10:30	0	0	9	0	0	0	0	0	0	160	0	0	0	151	0	0	320
10:30-10:45	0	0	13	5	0	0	0	1	0	138	0	1	0	169	0	0	327
10:45-11:00	0	0	18	1	0	0	0	0	0	147	2	1	0	151	0	0	320
11:00-11:15	0	0	17	2	0	0	0	0	0	147	2	0	0	181	0	0	349
11:15-11:30	0	0	21	0	0	0	0	0	0	148	0	0	0	169	0	0	338
11:30-11:45	0	0	16	0	0	0	0	0	0	160	0	0	0	183	0	0	359
11:45-12:00	0	0	21	0	0	0	0	0	0	148	0	0	0	178	0	0	347
12:00-12:15	0	0	13	0	0	0	0	0	0	186	1	0	0	182	0	0	382
12:15-12:30	0	0	20	1	0	0	0	1	0	159	0	0	0	199	0	0	380
12:30-12:45	0	0	19	1	0	0	0	0	0	167	0	0	0	214	0	0	401
12:45-1:00	0	0	20	2	0	0	0	0	0	184	0	0	0	198	0	0	404
1:00-1:15	0	0	24	0	0	0	0	0	0	181	0	0	0	216	0	0	421
1:15-1:30	0	0	10	0	0	0	0	3	0	178	0	0	0	202	0	0	393
1:30-1:45	0	0	21	1	0	0	0	0	0	181	0	1	0	197	0	1	402
1:45-2:00	0	0	10	1	0	0	0	0	0	150	0	2	0	190	0	0	353
2:00-2:15	0	0	16	0	0	0	0	2	0	158	1	0	0	217	0	0	394
2:15-2:30	0	0	15	0	0	0	0	1	0	166	3	0	0	211	0	0	396
2:30-2:45	0	0	22	0	0	0	0	3	0	197	4	0	0	245	0	0	471
2:45-3:00	0	0	17	0	0	0	0	0	0	224	0	0	0	254	0	0	495
3:00-3:15	0	0	20	1	0	0	0	0	0	221	0	0	0	265	0	0	507
3:15-3:30	0	0	22	0	0	0	0	1	0	261	1	1	0	286	0	0	572
3:30-3:45	0	0	16	0	0	0	0	0	0	235	0	0	0	275	0	0	526
3:45-4:00	0	0	13	0	0	0	0	0	0	295	0	0	0	260	0	0	568
4:00-4:15	0	0	28	0	0	0	0	0	0	276	1	0	1	336	0	1	643
4:15-4:30	0	0	21	0	0	0	0	2	0	280	1	0	0	289	0	0	593
4:30-4:45	0	0	24	1	0	0	0	0	0	266	0	0	0	303	0	0	594
4:45-5:00	0	0	16	0	0	0	0	0	0	252	0	0	0	309	0	0	577
5:00-5:15	0	0	19	0	0	0	0	0	0	281	0	0	0	330	0	0	630
5:15-5:30	0	0	25	0	0	0	0	0	0	246	1	1	0	336	0	0	609
5:30-5:45	0	0	23	0	0	0	0	3	0	279	0	1	0	336	0	1	643
5:45-6:00	0	0	19	0	0	0	0	0	0	261	1	0	0	335	0	0	616
6:00-6:15	0	0	25	0	0	0	0	0	0	254	0	0	0	305	0	0	584
6:15-6:30	0	0	19	0	0	0	0	0	0	233	1	0	0	257	0	0	510
6:30-6:45	0	0	13	0	0	0	0	0	0	218	0	0	0	263	0	0	494
6:45-7:00	0	0	18	0	0	0	0	0	0	206	0	0	0	244	0	0	468

	East Site Access Northbound				N/A Southbound				MD 198 Eastbound				MD 198 Westbound				Total
	Left	Thru	Right	Peds	Left	Thru	Right	Peds	Left	Thru	Right	Peds	Left	Thru	Right	Peds	
Hourly Totals																	
6:00-7:00	0	0	86	1	0	0	0	2	0	611	0	1	0	786	0	2	1489
7:00-8:00	0	0	95	0	0	0	0	0	0	832	1	0	0	1292	0	1	2221
8:00-9:00	0	0	74	0	0	0	0	1	0	882	2	0	0	1038	0	0	1997
9:00-10:00	0	0	72	1	0	0	0	4	0	744	1	0	0	815	0	4	1641
10:00-11:00	0	0	54	6	0	0	0	1	0	577	5	4	0	637	0	0	1284
11:00-12:00	0	0	75	2	0	0	0	0	0	603	2	0	0	711	0	0	1393
12:00-1:00	0	0	72	4	0	0	0	1	0	696	1	0	0	793	0	0	1567
1:00-2:00	0	0	65	2	0	0	0	3	0	690	0	3	0	805	0	1	1569
2:00-3:00	0	0	70	0	0	0	0	6	0	745	8	0	0	927	0	0	1756
3:00-4:00	0	0	71	1	0	0	0	1	0	1012	1	1	0	1086	0	0	2173
4:00-5:00	0	0	89	1	0	0	0	2	0	1074	2	0	1	1237	0	1	2407
5:00-6:00	0	0	86	0	0	0	0	3	0	1067	2	2	0	1337	0	1	2498
6:00-7:00	0	0	75	0	0	0	0	0	0	911	1	0	0	1069	0	0	2056

Peak Hour
Turning Movement Count

Intersection: MD 198 & East Site Access

Weather: Clear

Count by: Count Cam

Count Day/Date: Wednesday, May 4, 2022

County: Montgomery



LENHART TRAFFIC CONSULTING, INC.

645 BALTIMORE ANNAPOLIS BLVD, SUITE 214
SEVERNA PARK, MD 21146
www.lenharttraffic.com

13-Hour Turning Movement Count (6:00 am - 7:00 pm) HEAVY VEHICLES

Time:	West Site Access Northbound				Shopping Center Access Southbound				MD 198 Eastbound				MD 198 Westbound				Total
	Left	Thru	Right	Peds	Left	Thru	Right	Peds	Left	Thru	Right	Peds	Left	Thru	Right	Peds	
6:00-6:15	0	0	0	1	0	0	0	0	0	6	2	0	0	5	1	1	16
6:15-6:30	0	0	0	4	0	0	0	0	1	11	1	0	0	6	0	0	23
6:30-6:45	0	0	0	0	1	0	0	1	0	15	4	0	0	18	0	0	39
6:45-7:00	0	0	0	0	0	0	0	0	0	10	1	0	2	8	0	0	21
7:00-7:15	0	0	0	0	0	0	0	0	1	16	1	1	3	16	1	0	39
7:15-7:30	0	0	0	1	0	0	0	0	1	12	4	0	2	14	1	0	35
7:30-7:45	0	0	0	0	0	0	0	0	0	13	1	0	2	20	0	0	36
7:45-8:00	0	0	0	2	0	0	1	0	1	14	4	0	2	16	1	0	41
8:00-8:15	1	0	0	1	0	1	1	0	2	9	0	0	0	7	1	0	23
8:15-8:30	0	0	0	0	0	0	3	1	0	10	0	0	2	8	0	0	24
8:30-8:45	0	0	0	0	1	0	0	0	0	7	0	0	1	7	0	0	16
8:45-9:00	1	0	0	0	0	0	0	1	0	8	1	1	0	11	1	0	24
9:00-9:15	0	0	0	0	1	0	0	1	1	9	0	0	1	11	0	0	24
9:15-9:30	0	0	0	4	0	0	1	0	0	14	0	0	3	13	1	0	36
9:30-9:45	1	0	0	0	0	0	0	0	0	6	0	0	0	12	0	0	19
9:45-10:00	0	0	0	0	0	0	0	0	0	9	1	0	1	7	1	0	19
10:00-10:15	0	0	1	1	0	0	0	1	1	1	1	0	0	14	0	1	21
10:15-10:30	0	0	0	0	0	0	1	0	1	9	0	0	0	6	0	0	17
10:30-10:45	0	0	0	0	0	0	1	0	2	9	0	0	0	4	1	1	18
10:45-11:00	0	0	0	1	1	0	0	0	0	4	0	0	2	4	0	0	12
11:00-11:15	0	0	0	5	0	0	3	0	0	11	0	0	0	7	0	0	26
11:15-11:30	1	0	0	0	0	0	0	0	0	7	1	0	1	8	1	0	19
11:30-11:45	0	0	0	0	0	0	0	0	0	9	2	0	0	5	3	0	19
11:45-12:00	0	0	0	2	1	0	0	0	0	10	0	0	0	5	0	0	18
12:00-12:15	0	0	0	0	2	0	0	0	0	16	0	0	0	10	1	0	29
12:15-12:30	0	0	0	1	0	0	3	1	2	9	0	0	0	7	0	0	23
12:30-12:45	0	0	0	1	0	0	1	1	3	11	0	0	0	12	0	0	29
12:45-1:00	0	0	0	0	0	0	0	0	0	10	2	0	1	6	0	0	19
1:00-1:15	0	0	0	0	0	0	1	0	0	9	0	0	1	7	0	0	18
1:15-1:30	0	0	0	0	0	0	0	1	2	8	1	0	0	9	0	0	21
1:30-1:45	0	0	0	1	1	0	1	1	1	9	1	1	0	10	0	0	26
1:45-2:00	0	0	0	1	0	0	2	2	1	9	0	2	0	8	1	0	26
2:00-2:15	0	0	0	0	0	0	1	1	0	10	0	0	1	11	0	0	24
2:15-2:30	0	0	0	0	0	0	1	2	0	9	0	0	0	6	0	0	18
2:30-2:45	0	1	0	1	0	0	0	2	0	10	1	0	0	16	0	0	31
2:45-3:00	0	0	0	0	0	0	0	0	0	7	0	1	1	10	0	0	19
3:00-3:15	0	0	1	1	0	0	0	0	0	9	1	0	1	16	0	0	29
3:15-3:30	0	0	1	1	0	0	0	0	0	8	0	0	0	12	1	0	23
3:30-3:45	0	0	0	1	0	0	0	3	0	7	0	0	1	12	2	0	26
3:45-4:00	0	0	0	0	0	0	0	0	0	9	0	0	0	12	0	0	21
4:00-4:15	1	0	0	0	0	0	0	0	1	13	0	0	0	11	0	0	26
4:15-4:30	0	0	0	1	0	0	0	4	0	8	0	0	0	16	0	0	29
4:30-4:45	0	0	0	1	0	0	0	0	0	4	0	0	0	5	0	0	10
4:45-5:00	0	0	0	0	1	0	0	0	0	8	0	0	0	8	0	0	17
5:00-5:15	0	0	0	0	0	0	0	0	0	4	0	0	0	13	1	0	18
5:15-5:30	0	0	0	0	0	0	0	0	0	6	0	0	0	6	0	0	12
5:30-5:45	0	0	0	0	0	0	1	3	0	4	1	0	0	7	0	1	17
5:45-6:00	0	0	0	0	0	0	1	0	0	5	0	0	0	10	0	0	16
6:00-6:15	0	0	0	0	0	0	0	1	0	4	0	0	1	5	0	0	11
6:15-6:30	0	0	0	1	0	0	0	0	0	3	0	0	0	3	1	0	8
6:30-6:45	1	0	0	1	0	0	0	0	0	7	1	0	0	8	0	0	18
6:45-7:00	0	0	0	2	1	0	1	0	0	1	0	0	1	4	0	0	10

	West Site Access Northbound				Shopping Center Access Southbound				MD 198 Eastbound				MD 198 Westbound				Total
	Left	Thru	Right	Peds	Left	Thru	Right	Peds	Left	Thru	Right	Peds	Left	Thru	Right	Peds	
Hourly Totals																	
6:00-7:00	0	0	0	5	1	0	0	1	1	42	8	0	2	37	1	1	99
7:00-8:00	0	0	0	3	0	0	1	0	3	55	10	1	9	66	3	0	151
8:00-9:00	2	0	0	1	1	1	4	2	2	34	1	1	3	33	2	0	87
9:00-10:00	1	0	0	4	1	0	1	1	1	38	1	0	5	43	2	0	98
10:00-11:00	0	0	1	2	1	0	2	1	4	23	1	0	2	28	1	2	68
11:00-12:00	1	0	0	7	1	0	3	0	0	37	3	0	1	25	4	0	82
12:00-1:00	0	0	0	2	2	0	4	2	5	46	2	0	1	35	1	0	100
1:00-2:00	0	0	0	2	1	0	4	4	4	35	2	3	1	34	1	0	91
2:00-3:00	0	1	0	1	0	0	2	5	0	36	1	1	2	43	0	0	92
3:00-4:00	0	0	2	3	0	0	0	3	0	33	1	0	2	52	3	0	99
4:00-5:00	1	0	0	2	1	0	0	4	1	33	0	0	0	40	0	0	82
5:00-6:00	0	0	0	0	0	0	2	3	0	19	1	0	0	36	1	1	63
6:00-7:00	1	0	0	4	1	0	1	1	0	15	1	0	2	20	1	0	47

Peak Hour
Turning Movement Count

Intersection: MD 198 & West Site Access/Shopping Center Access (Heavy Vehicles)

Weather: Clear

Count by: Count Cam

Count Day/Date: Wednesday, May 4, 2022

County: Montgomery



LENHART TRAFFIC CONSULTING, INC.

645 BALTIMORE ANNAPOLIS BLVD, SUITE 214
SEVERNA PARK, MD 21146
www.lenharttraffic.com

13-Hour Turning Movement Count (6:00 am - 7:00 pm) HEAVY VEHICLES

Time:	East Site Access Northbound				N/A Southbound				MD 198 Eastbound				MD 198 Westbound				Total
	Left	Thru	Right	Peds	Left	Thru	Right	Peds	Left	Thru	Right	Peds	Left	Thru	Right	Peds	
6:00-6:15	0	0	2	0	0	0	0	1	0	6	0	1	0	6	0	0	16
6:15-6:30	0	0	2	1	0	0	0	0	0	12	0	0	0	7	0	1	23
6:30-6:45	0	0	0	0	0	0	0	1	0	18	0	0	0	17	0	0	36
6:45-7:00	0	0	5	0	0	0	0	0	0	10	0	0	0	10	0	1	26
7:00-7:15	0	0	4	0	0	0	0	0	0	15	0	0	0	22	0	1	42
7:15-7:30	0	0	2	0	0	0	0	0	0	12	0	0	0	17	0	0	31
7:30-7:45	0	0	5	0	0	0	0	0	0	16	0	0	0	25	0	0	46
7:45-8:00	0	0	5	0	0	0	0	0	0	14	0	0	0	21	0	0	40
8:00-8:15	0	0	2	0	0	0	0	0	0	9	0	0	0	8	0	0	19
8:15-8:30	0	0	2	0	0	0	0	1	0	11	0	0	0	10	0	0	24
8:30-8:45	0	0	2	0	0	0	0	0	0	11	0	0	0	8	0	0	21
8:45-9:00	0	0	0	0	0	0	0	0	0	8	0	0	0	12	0	0	20
9:00-9:15	0	0	1	1	0	0	0	0	0	10	0	0	0	13	0	0	25
9:15-9:30	0	0	3	0	0	0	0	3	0	14	1	0	0	17	0	0	38
9:30-9:45	0	0	0	0	0	0	0	0	0	6	0	0	0	14	0	4	24
9:45-10:00	0	0	1	0	0	0	0	1	0	10	0	0	0	8	0	0	20
10:00-10:15	0	0	1	0	0	0	0	0	0	2	0	2	0	14	0	0	19
10:15-10:30	0	0	1	0	0	0	0	0	0	10	0	0	0	6	0	0	17
10:30-10:45	0	0	0	5	0	0	0	1	0	8	0	1	0	5	0	0	20
10:45-11:00	0	0	0	1	0	0	0	0	0	5	0	1	0	6	0	0	13
11:00-11:15	0	0	1	2	0	0	0	0	0	11	0	0	0	7	0	0	21
11:15-11:30	0	0	2	0	0	0	0	0	0	7	0	0	0	11	0	0	20
11:30-11:45	0	0	1	0	0	0	0	0	0	10	0	0	0	9	0	0	20
11:45-12:00	0	0	1	0	0	0	0	0	0	11	0	0	0	4	0	0	16
12:00-12:15	0	0	0	0	0	0	0	0	0	19	0	0	0	11	0	0	30
12:15-12:30	0	0	0	1	0	0	0	1	0	9	0	0	0	7	0	0	18
12:30-12:45	0	0	1	1	0	0	0	0	0	11	0	0	0	12	0	0	25
12:45-1:00	0	0	1	2	0	0	0	0	0	10	0	0	0	9	0	0	22
1:00-1:15	0	0	2	0	0	0	0	0	0	10	0	0	0	7	0	0	19
1:15-1:30	0	0	1	0	0	0	0	3	0	8	0	0	0	9	0	0	21
1:30-1:45	0	0	2	1	0	0	0	0	0	11	0	1	0	10	0	1	26
1:45-2:00	0	0	1	1	0	0	0	0	0	9	0	2	0	9	0	0	22
2:00-2:15	0	0	1	0	0	0	0	2	0	9	0	0	0	14	0	0	26
2:15-2:30	0	0	0	0	0	0	0	1	0	9	1	0	0	5	0	0	16
2:30-2:45	0	0	0	0	0	0	0	3	0	11	0	0	0	16	0	0	30
2:45-3:00	0	0	0	0	0	0	0	0	0	7	0	0	0	11	0	0	18
3:00-3:15	0	0	1	1	0	0	0	0	0	10	0	0	0	17	0	0	29
3:15-3:30	0	0	1	0	0	0	0	1	0	9	0	1	0	13	0	0	25
3:30-3:45	0	0	0	0	0	0	0	0	0	8	0	0	0	16	0	0	24
3:45-4:00	0	0	0	0	0	0	0	0	0	9	0	0	0	13	0	0	22
4:00-4:15	0	0	0	0	0	0	0	0	0	14	0	0	0	10	0	1	25
4:15-4:30	0	0	0	0	0	0	0	2	0	8	0	0	0	16	0	0	26
4:30-4:45	0	0	0	1	0	0	0	0	0	4	0	0	0	5	0	0	10
4:45-5:00	0	0	0	0	0	0	0	0	0	5	0	0	0	8	0	0	13
5:00-5:15	0	0	0	0	0	0	0	0	0	3	0	0	0	15	0	0	18
5:15-5:30	0	0	0	0	0	0	0	0	0	6	0	1	0	6	0	0	13
5:30-5:45	0	0	0	0	0	0	0	3	0	4	0	1	0	7	0	1	16
5:45-6:00	0	0	1	0	0	0	0	0	0	5	0	0	0	10	0	0	16
6:00-6:15	0	0	0	0	0	0	0	0	0	5	0	0	0	7	0	0	12
6:15-6:30	0	0	0	0	0	0	0	0	0	3	0	0	0	4	0	0	7
6:30-6:45	0	0	0	0	0	0	0	0	0	7	0	0	0	8	0	0	15
6:45-7:00	0	0	2	0	0	0	0	0	0	2	0	0	0	5	0	0	9

	East Site Access Northbound				N/A Southbound				MD 198 Eastbound				MD 198 Westbound				Total
	Left	Thru	Right	Peds	Left	Thru	Right	Peds	Left	Thru	Right	Peds	Left	Thru	Right	Peds	
Hourly Totals																	
6:00-7:00	0	0	9	1	0	0	0	2	0	46	0	1	0	40	0	2	101
7:00-8:00	0	0	16	0	0	0	0	0	0	57	0	0	0	85	0	1	159
8:00-9:00	0	0	6	0	0	0	0	1	0	39	0	0	0	38	0	0	84
9:00-10:00	0	0	5	1	0	0	0	4	0	40	1	0	0	52	0	4	107
10:00-11:00	0	0	2	6	0	0	0	1	0	25	0	4	0	31	0	0	69
11:00-12:00	0	0	5	2	0	0	0	0	0	39	0	0	0	31	0	0	77
12:00-1:00	0	0	2	4	0	0	0	1	0	49	0	0	0	39	0	0	95
1:00-2:00	0	0	6	2	0	0	0	3	0	38	0	3	0	35	0	1	88
2:00-3:00	0	0	1	0	0	0	0	6	0	36	1	0	0	46	0	0	90
3:00-4:00	0	0	2	1	0	0	0	1	0	36	0	1	0	59	0	0	100
4:00-5:00	0	0	0	1	0	0	0	2	0	31	0	0	0	39	0	1	74
5:00-6:00	0	0	1	0	0	0	0	3	0	18	0	2	0	38	0	1	63
6:00-7:00	0	0	2	0	0	0	0	0	0	17	0	0	0	24	0	0	43

Peak Hour
Turning Movement Count

Intersection: MD 198 & East Site Access (Heavy Vehicles)

Weather: Clear

Count by: Count Cam

Count Day/Date: Wednesday, May 4, 2022

County: Montgomery



LENHART TRAFFIC CONSULTING, INC.

























645 BALTIMORE ANNAPOLIS BLVD, SUITE 214
SEVERNA PARK, MD 21146
www.lenharttraffic.com

Appendix B

Level of Service (LOS) Worksheets

HCM Signalized Intersection Capacity Analysis
 1: US 29 NB Off Ramp/US 29 NB On Ramp & MD 198

Cheng Property
 AM Existing

													
Movement	EBL	EBT	EBR	WBL	WBT	WBR	NBL	NBT	NBR	SBL	SBT	SBR	
Lane Configurations	 	  			  								
Traffic Volume (vph)	256	898	0	0	1240	217	186	0	292	0	0	0	
Future Volume (vph)	256	898	0	0	1240	217	186	0	292	0	0	0	
Ideal Flow (vphpl)	1900	1900	1900	1900	1900	1900	1900	1900	1900	1900	1900	1900	
Total Lost time (s)	4.5	4.5			4.5	4.5	4.5	4.5	4.5				
Lane Util. Factor	0.97	0.91			0.91	1.00	0.95	0.95	1.00				
Frt	1.00	1.00			1.00	0.85	1.00	1.00	0.85				
Flt Protected	0.95	1.00			1.00	1.00	0.95	0.95	1.00				
Satd. Flow (prot)	3433	5085			5085	1583	1681	1681	1583				
Flt Permitted	0.95	1.00			1.00	1.00	0.95	0.95	1.00				
Satd. Flow (perm)	3433	5085			5085	1583	1681	1681	1583				
Peak-hour factor, PHF	0.92	0.92	0.92	0.92	0.92	0.92	0.92	0.92	0.92	0.92	0.92	0.92	
Adj. Flow (vph)	278	976	0	0	1348	236	202	0	317	0	0	0	
RTOR Reduction (vph)	0	0	0	0	0	94	0	0	164	0	0	0	
Lane Group Flow (vph)	278	976	0	0	1348	142	101	101	153	0	0	0	
Turn Type	Prot	NA			NA	Perm	Perm	NA	Perm				
Protected Phases	7	4			8			2					
Permitted Phases						8	2		2				
Actuated Green, G (s)	16.6	105.5			84.4	84.4	25.5	25.5	25.5				
Effective Green, g (s)	16.6	105.5			84.4	84.4	25.5	25.5	25.5				
Actuated g/C Ratio	0.12	0.75			0.60	0.60	0.18	0.18	0.18				
Clearance Time (s)	4.5	4.5			4.5	4.5	4.5	4.5	4.5				
Vehicle Extension (s)	3.0	3.0			3.0	3.0	3.0	3.0	3.0				
Lane Grp Cap (vph)	407	3831			3065	954	306	306	288				
v/s Ratio Prot	c0.08	0.19			c0.27								
v/s Ratio Perm						0.09	0.06	0.06	c0.10				
v/c Ratio	0.68	0.25			0.44	0.15	0.33	0.33	0.53				
Uniform Delay, d1	59.2	5.3			15.0	12.1	49.8	49.8	51.9				
Progression Factor	0.87	2.66			1.00	1.00	1.00	1.00	1.00				
Incremental Delay, d2	4.6	0.2			0.5	0.3	2.9	2.9	6.9				
Delay (s)	55.9	14.1			15.5	12.5	52.7	52.7	58.8				
Level of Service	E	B			B	B	D	D	E				
Approach Delay (s)		23.4			15.0			56.4			0.0		
Approach LOS		C			B			E			A		
Intersection Summary													
HCM 2000 Control Delay			24.6		HCM 2000 Level of Service					C			
HCM 2000 Volume to Capacity ratio			0.49										
Actuated Cycle Length (s)			140.0		Sum of lost time (s)					13.5			
Intersection Capacity Utilization			47.7%		ICU Level of Service					A			
Analysis Period (min)			15										

c Critical Lane Group

HCM Signalized Intersection Capacity Analysis

2: Old Columbia Pike & MD 198

Cheng Property
AM Existing



Movement	EBL	EBT	EBR	WBL	WBT	WBR	NBL	NBT	NBR	SBL	SBT	SBR
Lane Configurations	↖	↑↑↑	↗	↖↗	↑↑	↗				↖↗	↖↗	↗
Traffic Volume (vph)	88	796	97	264	915	152	0	0	0	296	98	375
Future Volume (vph)	88	796	97	264	915	152	0	0	0	296	98	375
Ideal Flow (vphpl)	1900	1900	1900	1900	1900	1900	1900	1900	1900	1900	1900	1900
Total Lost time (s)	4.5	4.5	4.5	4.5	4.5	4.5				4.5	4.5	4.5
Lane Util. Factor	1.00	0.91	1.00	0.97	0.95	1.00				0.86	0.86	1.00
Frt	1.00	1.00	0.85	1.00	1.00	0.85				1.00	1.00	0.85
Flt Protected	0.95	1.00	1.00	0.95	1.00	1.00				0.95	0.98	1.00
Satd. Flow (prot)	1770	5085	1583	3433	3539	1583				3044	3126	1583
Flt Permitted	0.95	1.00	1.00	0.95	1.00	1.00				0.95	0.98	1.00
Satd. Flow (perm)	1770	5085	1583	3433	3539	1583				3044	3126	1583
Peak-hour factor, PHF	0.92	0.92	0.92	0.92	0.92	0.92	0.92	0.92	0.92	0.92	0.92	0.92
Adj. Flow (vph)	96	865	105	287	995	165	0	0	0	322	107	408
RTOR Reduction (vph)	0	0	50	0	0	72	0	0	0	0	0	204
Lane Group Flow (vph)	96	865	56	287	995	93	0	0	0	216	213	204
Turn Type	Prot	NA	Perm	Prot	NA	Perm				Perm	NA	Perm
Protected Phases	7	4		3	8						6	
Permitted Phases			4			8				6		6
Actuated Green, G (s)	12.4	74.0	74.0	17.0	78.6	78.6				35.5	35.5	35.5
Effective Green, g (s)	12.4	74.0	74.0	17.0	78.6	78.6				35.5	35.5	35.5
Actuated g/C Ratio	0.09	0.53	0.53	0.12	0.56	0.56				0.25	0.25	0.25
Clearance Time (s)	4.5	4.5	4.5	4.5	4.5	4.5				4.5	4.5	4.5
Vehicle Extension (s)	3.0	3.0	3.0	3.0	3.0	3.0				3.0	3.0	3.0
Lane Grp Cap (vph)	156	2687	836	416	1986	888				771	792	401
v/s Ratio Prot	0.05	0.17		c0.08	c0.28							
v/s Ratio Perm			0.04			0.06				0.07	0.07	c0.13
v/c Ratio	0.62	0.32	0.07	0.69	0.50	0.10				0.28	0.27	0.51
Uniform Delay, d1	61.5	18.7	16.1	59.0	18.7	14.3				42.0	41.9	44.8
Progression Factor	0.94	0.79	1.42	0.82	1.57	5.73				0.96	0.96	0.96
Incremental Delay, d2	6.7	0.3	0.1	4.4	0.8	0.2				0.9	0.8	4.5
Delay (s)	64.7	15.1	23.1	52.7	30.2	82.2				41.2	40.9	47.5
Level of Service	E	B	C	D	C	F				D	D	D
Approach Delay (s)		20.4			40.6			0.0			44.2	
Approach LOS		C			D			A			D	

Intersection Summary























HCM 2000 Control Delay	35.1	HCM 2000 Level of Service	D
HCM 2000 Volume to Capacity ratio	0.54		
Actuated Cycle Length (s)	140.0	Sum of lost time (s)	13.5
Intersection Capacity Utilization	56.0%	ICU Level of Service	B
Analysis Period (min)	15		

c Critical Lane Group

HCM Signalized Intersection Capacity Analysis

3: Old Columbia Pike & National Drive

Cheng Property
AM Existing

												
Movement	EBL	EBT	EBR	WBL	WBT	WBR	NBL	NBT	NBR	SBL	SBT	SBR
Lane Configurations												
Traffic Volume (vph)	47	6	150	24	0	1	149	96	22	10	616	72
Future Volume (vph)	47	6	150	24	0	1	149	96	22	10	616	72
Ideal Flow (vphpl)	1900	1900	1900	1900	1900	1900	1900	1900	1900	1900	1900	1900
Total Lost time (s)		4.5	4.5	4.5	4.5		4.5	4.5	4.5	4.5	4.5	4.5
Lane Util. Factor		1.00	1.00	1.00	1.00		1.00	0.91	1.00	1.00	0.91	1.00
Frt		1.00	0.85	1.00	0.85		1.00	1.00	0.85	1.00	1.00	0.85
Flt Protected		0.96	1.00	0.95	1.00		0.95	1.00	1.00	0.95	1.00	1.00
Satd. Flow (prot)		1784	1583	1770	1583		1770	5085	1583	1770	5085	1583
Flt Permitted		0.75	1.00	0.72	1.00		0.39	1.00	1.00	0.68	1.00	1.00
Satd. Flow (perm)		1399	1583	1340	1583		718	5085	1583	1273	5085	1583
Peak-hour factor, PHF	0.92	0.92	0.92	0.92	0.92	0.92	0.92	0.92	0.92	0.92	0.92	0.92
Adj. Flow (vph)	51	7	163	26	0	1	162	104	24	11	670	78
RTOR Reduction (vph)	0	0	144	0	1	0	0	0	6	0	0	19
Lane Group Flow (vph)	0	58	19	26	0	0	162	104	18	11	670	59
Turn Type	Perm	NA	Perm	Perm	NA		Perm	NA	Perm	Perm	NA	Perm
Protected Phases		4			8			2			6	
Permitted Phases	4		4	8			2		2	6		6
Actuated Green, G (s)		8.3	8.3	8.3	8.3		52.7	52.7	52.7	52.7	52.7	52.7
Effective Green, g (s)		8.3	8.3	8.3	8.3		52.7	52.7	52.7	52.7	52.7	52.7
Actuated g/C Ratio		0.12	0.12	0.12	0.12		0.75	0.75	0.75	0.75	0.75	0.75
Clearance Time (s)		4.5	4.5	4.5	4.5		4.5	4.5	4.5	4.5	4.5	4.5
Vehicle Extension (s)		3.0	3.0	3.0	3.0		3.0	3.0	3.0	3.0	3.0	3.0
Lane Grp Cap (vph)		165	187	158	187		540	3828	1191	958	3828	1191
v/s Ratio Prot					0.00			0.02			0.13	
v/s Ratio Perm		c0.04	0.01	0.02			c0.23		0.01	0.01		0.04
v/c Ratio		0.35	0.10	0.16	0.00		0.30	0.03	0.02	0.01	0.18	0.05
Uniform Delay, d1		28.4	27.5	27.7	27.2		2.8	2.2	2.2	2.2	2.5	2.2
Progression Factor		1.00	1.00	1.00	1.00		3.07	1.65	2.73	1.00	1.00	1.00
Incremental Delay, d2		1.3	0.2	0.5	0.0		1.4	0.0	0.0	0.0	0.1	0.1
Delay (s)		29.7	27.8	28.2	27.2		9.9	3.6	5.9	2.2	2.6	2.3
Level of Service		C	C	C	C		A	A	A	A	A	A
Approach Delay (s)		28.3			28.2			7.3			2.5	
Approach LOS		C			C			A			A	
Intersection Summary												
HCM 2000 Control Delay			8.5									A
HCM 2000 Volume to Capacity ratio			0.31									
Actuated Cycle Length (s)			70.0								9.0	
Intersection Capacity Utilization			41.0%									A
Analysis Period (min)			15									

c Critical Lane Group

HCM Signalized Intersection Capacity Analysis

4: Old Columbia Pike & MD 198

Cheng Property
AM Existing

Movement	EBL	EBT	EBR	WBL	WBT	WBR	NBL	NBT	NBR	SBL	SBT	SBR
Lane Configurations												
Traffic Volume (vph)	12	792	87	254	935	6	112	6	196	12	7	4
Future Volume (vph)	12	792	87	254	935	6	112	6	196	12	7	4
Ideal Flow (vphpl)	1900	1900	1900	1900	1900	1900	1900	1900	1900	1900	1900	1900
Total Lost time (s)	4.5	4.5		4.5	4.5		4.5	4.5	4.5	4.5	4.5	
Lane Util. Factor	1.00	0.95		1.00	0.95		1.00	1.00	1.00	1.00	1.00	
Frt	1.00	0.99		1.00	1.00		1.00	1.00	0.85	1.00	0.95	
Flt Protected	0.95	1.00		0.95	1.00		0.95	1.00	1.00	0.95	1.00	
Satd. Flow (prot)	1770	3486		1770	3536		1770	1863	1583	1770	1770	
Flt Permitted	0.27	1.00		0.24	1.00		0.75	1.00	1.00	0.75	1.00	
Satd. Flow (perm)	503	3486		438	3536		1397	1863	1583	1403	1770	
Peak-hour factor, PHF	0.92	0.92	0.92	0.92	0.92	0.92	0.92	0.92	0.92	0.92	0.92	0.92
Adj. Flow (vph)	13	861	95	276	1016	7	122	7	213	13	8	4
RTOR Reduction (vph)	0	5	0	0	0	0	0	0	174	0	3	0
Lane Group Flow (vph)	13	951	0	276	1023	0	122	7	39	13	9	0
Turn Type	pm+pt	NA		pm+pt	NA		Perm	NA	Perm	Perm	NA	
Protected Phases	7	4		3	8			2			6	
Permitted Phases	4			8			2		2	6		
Actuated Green, G (s)	91.0	88.6		105.5	98.6		25.5	25.5	25.5	25.5	25.5	
Effective Green, g (s)	91.0	88.6		105.5	98.6		25.5	25.5	25.5	25.5	25.5	
Actuated g/C Ratio	0.65	0.63		0.75	0.70		0.18	0.18	0.18	0.18	0.18	
Clearance Time (s)	4.5	4.5		4.5	4.5		4.5	4.5	4.5	4.5	4.5	
Vehicle Extension (s)	3.0	3.0		3.0	3.0		3.0	3.0	3.0	3.0	3.0	
Lane Grp Cap (vph)	348	2206		448	2490		254	339	288	255	322	
v/s Ratio Prot	0.00	0.27		c0.05	0.29			0.00			0.00	
v/s Ratio Perm	0.02			c0.41			c0.09		0.02	0.01		
v/c Ratio	0.04	0.43		0.62	0.41		0.48	0.02	0.13	0.05	0.03	
Uniform Delay, d1	8.7	13.0		7.8	8.6		51.3	47.0	48.0	47.3	47.1	
Progression Factor	1.00	1.00		0.96	0.91		1.00	1.00	1.00	1.00	1.00	
Incremental Delay, d2	0.0	0.6		2.2	0.4		6.4	0.1	1.0	0.4	0.2	
Delay (s)	8.7	13.6		9.7	8.3		57.7	47.1	49.0	47.6	47.2	
Level of Service	A	B		A	A		E	D	D	D	D	
Approach Delay (s)		13.5			8.6			52.0			47.4	
Approach LOS		B			A			D			D	
Intersection Summary												
HCM 2000 Control Delay			16.4			HCM 2000 Level of Service			B			
HCM 2000 Volume to Capacity ratio			0.60									
Actuated Cycle Length (s)			140.0			Sum of lost time (s)			13.5			
Intersection Capacity Utilization			62.9%			ICU Level of Service			B			
Analysis Period (min)			15									

c Critical Lane Group

HCM Unsignalized Intersection Capacity Analysis
 5: Blackburn Road & US 29 SB Off Ramp



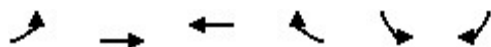

















Cheng Property
 AM Existing



Movement	EBL	EBT	WBT	WBR	SBL	SBR
Lane Configurations		↑	↑		↘	
Traffic Volume (veh/h)	0	33	49	0	61	4
Future Volume (Veh/h)	0	33	49	0	61	4
Sign Control		Free	Free		Stop	
Grade		0%	0%		0%	
Peak Hour Factor	0.92	0.92	0.92	0.92	0.92	0.92
Hourly flow rate (vph)	0	36	53	0	66	4
Pedestrians						
Lane Width (ft)						
Walking Speed (ft/s)						
Percent Blockage						
Right turn flare (veh)						
Median type		None	None			
Median storage (veh)						
Upstream signal (ft)						
pX, platoon unblocked						
vC, conflicting volume	53				89	53
vC1, stage 1 conf vol						
vC2, stage 2 conf vol						
vCu, unblocked vol	53				89	53
tC, single (s)	4.1				6.4	6.2
tC, 2 stage (s)						
tF (s)	2.2				3.5	3.3
p0 queue free %	100				93	100
cM capacity (veh/h)	1553				912	1014
Direction, Lane #	EB 1	WB 1	SB 1			
Volume Total	36	53	70			
Volume Left	0	0	66			
Volume Right	0	0	4			
cSH	1700	1700	917			
Volume to Capacity	0.02	0.03	0.08			
Queue Length 95th (ft)	0	0	6			
Control Delay (s)	0.0	0.0	9.3			
Lane LOS			A			
Approach Delay (s)	0.0	0.0	9.3			
Approach LOS			A			
Intersection Summary						
Average Delay			4.1			
Intersection Capacity Utilization		13.6%		ICU Level of Service		A
Analysis Period (min)			15			

HCM Unsignalized Intersection Capacity Analysis
6: Lions Den Drive/Burtonsville Drive & MD 198

Cheng Property
AM Existing

												
Movement	EBL	EBT	EBR	WBL	WBT	WBR	NBL	NBT	NBR	SBL	SBT	SBR
Lane Configurations												
Traffic Volume (veh/h)	0	867	6	3	1055	3	10	0	19	5	1	8
Future Volume (Veh/h)	0	867	6	3	1055	3	10	0	19	5	1	8
Sign Control		Free			Free			Stop			Stop	
Grade		0%			0%			0%			0%	
Peak Hour Factor	0.92	0.92	0.92	0.92	0.92	0.92	0.92	0.92	0.92	0.92	0.92	0.92
Hourly flow rate (vph)	0	942	7	3	1147	3	11	0	21	5	1	9
Pedestrians												
Lane Width (ft)												
Walking Speed (ft/s)												
Percent Blockage												
Right turn flare (veh)												
Median type	None					None						
Median storage (veh)												
Upstream signal (ft)												
pX, platoon unblocked												
vC, conflicting volume	1150			949			2104	2098	942	2118	2104	1148
vC1, stage 1 conf vol												
vC2, stage 2 conf vol												
vCu, unblocked vol	1150			949			2104	2098	942	2118	2104	1148
tC, single (s)	4.1			4.1			7.1	6.5	6.2	7.1	6.5	6.2
tC, 2 stage (s)												
tF (s)	2.2			2.2			3.5	4.0	3.3	3.5	4.0	3.3
p0 queue free %	100			100			69	100	93	85	98	96
cM capacity (veh/h)	608			724			36	52	319	34	51	242
Direction, Lane #	EB 1	EB 2	EB 3	WB 1	WB 2	NB 1	SB 1					
Volume Total	0	942	7	3	1150	32	15					
Volume Left	0	0	0	3	0	11	5					
Volume Right	0	0	7	0	3	21	9					
cSH	1700	1700	1700	724	1700	85	74					
Volume to Capacity	0.00	0.55	0.00	0.00	0.68	0.38	0.20					
Queue Length 95th (ft)	0	0	0	0	0	37	17					
Control Delay (s)	0.0	0.0	0.0	10.0	0.0	70.7	65.6					
Lane LOS				A		F	F					
Approach Delay (s)	0.0			0.0		70.7	65.6					
Approach LOS						F	F					
Intersection Summary												
Average Delay			1.5									
Intersection Capacity Utilization			65.7%	ICU Level of Service		C						
Analysis Period (min)			15									

HCM Signalized Intersection Capacity Analysis

7: Old Columbia Pike & Greencastle Road

Cheng Property
AM Existing



Movement	EBL	EBT	EBR	WBL	WBT	WBR	NBL	NBT	NBR	SBL	SBT	SBR
Lane Configurations		↕			↕			↕	↕		↕	
Traffic Volume (vph)	9	14	6	177	13	65	2	210	130	64	328	13
Future Volume (vph)	9	14	6	177	13	65	2	210	130	64	328	13
Ideal Flow (vphpl)	1900	1900	1900	1900	1900	1900	1900	1900	1900	1900	1900	1900
Total Lost time (s)		4.5			4.5			4.5	4.5		4.5	
Lane Util. Factor		1.00			1.00			1.00	1.00		1.00	
Frt		0.97			0.97			1.00	0.85		1.00	
Flt Protected		0.98			0.97			1.00	1.00		0.99	
Satd. Flow (prot)		1780			1738			1862	1583		1840	
Flt Permitted		0.89			0.77			1.00	1.00		0.92	
Satd. Flow (perm)		1604			1390			1858	1583		1709	
Peak-hour factor, PHF	0.92	0.92	0.92	0.92	0.92	0.92	0.92	0.92	0.92	0.92	0.92	0.92
Adj. Flow (vph)	10	15	7	192	14	71	2	228	141	70	357	14
RTOR Reduction (vph)	0	5	0	0	26	0	0	0	64	0	1	0
Lane Group Flow (vph)	0	27	0	0	251	0	0	230	77	0	440	0
Turn Type	Perm	NA		Perm	NA		Perm	NA	Perm	Perm	NA	
Protected Phases		2			6			4			8	
Permitted Phases	2			6			4		4	8		
Actuated Green, G (s)		13.9			13.9			27.3	27.3		27.3	
Effective Green, g (s)		13.9			13.9			27.3	27.3		27.3	
Actuated g/C Ratio		0.28			0.28			0.54	0.54		0.54	
Clearance Time (s)		4.5			4.5			4.5	4.5		4.5	
Vehicle Extension (s)		3.0			3.0			3.0	3.0		3.0	
Lane Grp Cap (vph)		444			384			1010	860		929	
v/s Ratio Prot												
v/s Ratio Perm		0.02			c0.18			0.12	0.05		c0.26	
v/c Ratio		0.06			0.65			0.23	0.09		0.47	
Uniform Delay, d1		13.3			16.0			6.0	5.5		7.0	
Progression Factor		1.00			1.00			1.00	1.00		1.00	
Incremental Delay, d2		0.1			4.0			0.5	0.2		1.7	
Delay (s)		13.4			20.0			6.5	5.7		8.8	
Level of Service		B			B			A	A		A	
Approach Delay (s)		13.4			20.0			6.2			8.8	
Approach LOS		B			B			A			A	

Intersection Summary

HCM 2000 Control Delay	10.8	HCM 2000 Level of Service	B
HCM 2000 Volume to Capacity ratio	0.53		
Actuated Cycle Length (s)	50.2	Sum of lost time (s)	9.0
Intersection Capacity Utilization	65.1%	ICU Level of Service	C
Analysis Period (min)	15		

c Critical Lane Group

HCM Unsignalized Intersection Capacity Analysis
 8: Site Access/Shopping Center & MD 198

Cheng Property
 AM Existing

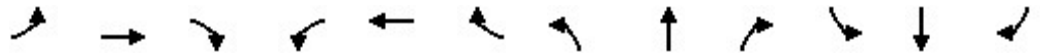

Movement	EBL	EBT	EBR	WBL	WBT	WBR	NBL	NBT	NBR	SBL	SBT	SBR
Lane Configurations												
Traffic Volume (veh/h)	93	831	59	65	1196	46	7	0	17	15	3	89
Future Volume (Veh/h)	93	831	59	65	1196	46	7	0	17	15	3	89
Sign Control		Free			Free			Stop			Stop	
Grade		0%			0%			0%			0%	
Peak Hour Factor	0.92	0.92	0.92	0.92	0.92	0.92	0.92	0.92	0.92	0.92	0.92	0.92
Hourly flow rate (vph)	101	903	64	71	1300	50	8	0	18	16	3	97
Pedestrians												
Lane Width (ft)												
Walking Speed (ft/s)												
Percent Blockage												
Right turn flare (veh)												
Median type												
		None			None							
Median storage (veh)												
Upstream signal (ft)												
		1205			528							
pX, platoon unblocked	0.83			0.92			0.87	0.87	0.92	0.87	0.87	0.83
vC, conflicting volume	1350			967			2028	2629	484	2114	2611	650
vC1, stage 1 conf vol												
vC2, stage 2 conf vol												
vCu, unblocked vol	1022			794			1483	2171	270	1581	2151	183
tC, single (s)	4.1			4.1			7.5	6.5	6.9	7.5	6.5	6.9
tC, 2 stage (s)												
tF (s)	2.2			2.2			3.5	4.0	3.3	3.5	4.0	3.3
p0 queue free %	82			91			84	100	97	68	90	86
cM capacity (veh/h)	563			758			49	30	671	50	31	691
Direction, Lane #	EB 1	EB 2	EB 3	WB 1	WB 2	WB 3	WB 4	NB 1	SB 1	SB 2		
Volume Total	101	602	365	71	650	650	50	26	19	97		
Volume Left	101	0	0	71	0	0	0	8	16	0		
Volume Right	0	0	64	0	0	0	50	18	0	97		
cSH	563	1700	1700	758	1700	1700	1700	136	46	691		
Volume to Capacity	0.18	0.35	0.21	0.09	0.38	0.38	0.03	0.19	0.42	0.14		
Queue Length 95th (ft)	16	0	0	8	0	0	0	17	37	12		
Control Delay (s)	12.8	0.0	0.0	10.2	0.0	0.0	0.0	37.7	132.1	11.1		
Lane LOS	B			B				E	F	B		
Approach Delay (s)	1.2			0.5				37.7	30.9			
Approach LOS								E	D			
Intersection Summary												
Average Delay			2.5									
Intersection Capacity Utilization			56.1%		ICU Level of Service				B			
Analysis Period (min)			15									

HCM Unsignalized Intersection Capacity Analysis
9: Site Access & MD 198

























Cheng Property
AM Existing



Movement	EBT	EBR	WBL	WBT	NBL	NBR	
Lane Configurations	↑↑↑			↑↑↑		↑	
Traffic Volume (veh/h)	899	2	0	1307	0	81	
Future Volume (Veh/h)	899	2	0	1307	0	81	
Sign Control	Free			Free	Stop		
Grade	0%			0%	0%		
Peak Hour Factor	0.92	0.92	0.92	0.92	0.92	0.92	
Hourly flow rate (vph)	977	2	0	1421	0	88	
Pedestrians							
Lane Width (ft)							
Walking Speed (ft/s)							
Percent Blockage							
Right turn flare (veh)							
Median type	None			None			
Median storage (veh)							
Upstream signal (ft)	279						
pX, platoon unblocked					0.85		
vC, conflicting volume	979			1452		327	
vC1, stage 1 conf vol							
vC2, stage 2 conf vol							
vCu, unblocked vol	979			927		327	
tC, single (s)	4.1			6.8		6.9	
tC, 2 stage (s)							
tF (s)	2.2			3.5		3.3	
p0 queue free %	100			100		87	
cM capacity (veh/h)	701			228		669	
Direction, Lane #	EB 1	EB 2	EB 3	WB 1	WB 2	WB 3	NB 1
Volume Total	391	391	197	474	474	474	88
Volume Left	0	0	0	0	0	0	0
Volume Right	0	0	2	0	0	0	88
cSH	1700	1700	1700	1700	1700	1700	669
Volume to Capacity	0.23	0.23	0.12	0.28	0.28	0.28	0.13
Queue Length 95th (ft)	0	0	0	0	0	0	11
Control Delay (s)	0.0	0.0	0.0	0.0	0.0	0.0	11.2
Lane LOS							B
Approach Delay (s)	0.0			0.0		11.2	
Approach LOS							B
Intersection Summary							
Average Delay	0.4						
Intersection Capacity Utilization	29.1%			ICU Level of Service		A	
Analysis Period (min)	15						

HCM Signalized Intersection Capacity Analysis
 1: US 29 NB Off Ramp/US 29 NB On Ramp & MD 198

Cheng Property
 AM Background

													
Movement	EBL	EBT	EBR	WBL	WBT	WBR	NBL	NBT	NBR	SBL	SBT	SBR	
Lane Configurations	 	  			  								
Traffic Volume (vph)	256	925	0	0	1369	217	186	0	292	0	0	0	
Future Volume (vph)	256	925	0	0	1369	217	186	0	292	0	0	0	
Ideal Flow (vphpl)	1900	1900	1900	1900	1900	1900	1900	1900	1900	1900	1900	1900	
Total Lost time (s)	4.5	4.5			4.5	4.5	4.5	4.5	4.5				
Lane Util. Factor	0.97	0.91			0.91	1.00	0.95	0.95	1.00				
Frt	1.00	1.00			1.00	0.85	1.00	1.00	0.85				
Flt Protected	0.95	1.00			1.00	1.00	0.95	0.95	1.00				
Satd. Flow (prot)	3433	5085			5085	1583	1681	1681	1583				
Flt Permitted	0.95	1.00			1.00	1.00	0.95	0.95	1.00				
Satd. Flow (perm)	3433	5085			5085	1583	1681	1681	1583				
Peak-hour factor, PHF	0.92	0.92	0.92	0.92	0.92	0.92	0.92	0.92	0.92	0.92	0.92	0.92	
Adj. Flow (vph)	278	1005	0	0	1488	236	202	0	317	0	0	0	
RTOR Reduction (vph)	0	0	0	0	0	94	0	0	155	0	0	0	
Lane Group Flow (vph)	278	1005	0	0	1488	142	101	101	162	0	0	0	
Turn Type	Prot	NA			NA	Perm	Perm	NA	Perm				
Protected Phases	7	4			8			2					
Permitted Phases						8	2		2				
Actuated Green, G (s)	16.6	105.5			84.4	84.4	25.5	25.5	25.5				
Effective Green, g (s)	16.6	105.5			84.4	84.4	25.5	25.5	25.5				
Actuated g/C Ratio	0.12	0.75			0.60	0.60	0.18	0.18	0.18				
Clearance Time (s)	4.5	4.5			4.5	4.5	4.5	4.5	4.5				
Vehicle Extension (s)	3.0	3.0			3.0	3.0	3.0	3.0	3.0				
Lane Grp Cap (vph)	407	3831			3065	954	306	306	288				
v/s Ratio Prot	c0.08	0.20			c0.29								
v/s Ratio Perm						0.09	0.06	0.06	c0.10				
v/c Ratio	0.68	0.26			0.49	0.15	0.33	0.33	0.56				
Uniform Delay, d1	59.2	5.3			15.6	12.1	49.8	49.8	52.2				
Progression Factor	0.87	2.56			1.00	1.00	1.00	1.00	1.00				
Incremental Delay, d2	4.5	0.2			0.6	0.3	2.9	2.9	7.7				
Delay (s)	55.9	13.7			16.2	12.5	52.7	52.7	59.8				
Level of Service	E	B			B	B	D	D	E				
Approach Delay (s)		22.9			15.7			57.1			0.0		
Approach LOS		C			B			E			A		
Intersection Summary													
HCM 2000 Control Delay			24.4		HCM 2000 Level of Service				C				
HCM 2000 Volume to Capacity ratio			0.53										
Actuated Cycle Length (s)			140.0		Sum of lost time (s)				13.5				
Intersection Capacity Utilization			50.2%		ICU Level of Service				A				
Analysis Period (min)			15										

c Critical Lane Group

HCM Signalized Intersection Capacity Analysis

2: Old Columbia Pike & MD 198

Cheng Property
AM Background



Movement	EBL	EBT	EBR	WBL	WBT	WBR	NBL	NBT	NBR	SBL	SBT	SBR
Lane Configurations												
Traffic Volume (vph)	174	796	97	278	915	216	0	0	0	323	138	429
Future Volume (vph)	174	796	97	278	915	216	0	0	0	323	138	429
Ideal Flow (vphpl)	1900	1900	1900	1900	1900	1900	1900	1900	1900	1900	1900	1900
Total Lost time (s)	4.5	4.5	4.5	4.5	4.5	4.5				4.5	4.5	4.5
Lane Util. Factor	1.00	0.91	1.00	0.97	0.95	1.00				0.86	0.86	1.00
Frt	1.00	1.00	0.85	1.00	1.00	0.85				1.00	1.00	0.85
Flt Protected	0.95	1.00	1.00	0.95	1.00	1.00				0.95	0.98	1.00
Satd. Flow (prot)	1770	5085	1583	3433	3539	1583				3044	3139	1583
Flt Permitted	0.95	1.00	1.00	0.95	1.00	1.00				0.95	0.98	1.00
Satd. Flow (perm)	1770	5085	1583	3433	3539	1583				3044	3139	1583
Peak-hour factor, PHF	0.92	0.92	0.92	0.92	0.92	0.92	0.92	0.92	0.92	0.92	0.92	0.92
Adj. Flow (vph)	189	865	105	302	995	235	0	0	0	351	150	466
RTOR Reduction (vph)	0	0	50	0	0	108	0	0	0	0	0	204
Lane Group Flow (vph)	189	865	55	302	995	127	0	0	0	246	255	262
Turn Type	Prot	NA	Perm	Prot	NA	Perm				Perm	NA	Perm
Protected Phases	7	4		3	8						6	
Permitted Phases			4			8				6		6
Actuated Green, G (s)	15.5	73.4	73.4	17.6	75.5	75.5				35.5	35.5	35.5
Effective Green, g (s)	15.5	73.4	73.4	17.6	75.5	75.5				35.5	35.5	35.5
Actuated g/C Ratio	0.11	0.52	0.52	0.13	0.54	0.54				0.25	0.25	0.25
Clearance Time (s)	4.5	4.5	4.5	4.5	4.5	4.5				4.5	4.5	4.5
Vehicle Extension (s)	3.0	3.0	3.0	3.0	3.0	3.0				3.0	3.0	3.0
Lane Grp Cap (vph)	195	2665	829	431	1908	853				771	795	401
v/s Ratio Prot	c0.11	0.17		0.09	c0.28							
v/s Ratio Perm			0.03			0.08				0.08	0.08	c0.17
v/c Ratio	0.97	0.32	0.07	0.70	0.52	0.15				0.32	0.32	0.65
Uniform Delay, d1	62.0	19.1	16.4	58.7	20.7	16.2				42.4	42.5	46.8
Progression Factor	0.97	0.77	1.18	0.80	1.56	6.98				0.95	0.95	0.91
Incremental Delay, d2	52.7	0.3	0.1	4.6	0.9	0.3				1.1	1.0	7.9
Delay (s)	113.0	14.9	19.6	51.7	33.1	113.1				41.4	41.4	50.4
Level of Service	F	B	B	D	C	F				D	D	D
Approach Delay (s)		31.3			49.0			0.0			45.7	
Approach LOS		C			D			A			D	























Intersection Summary

HCM 2000 Control Delay	42.5	HCM 2000 Level of Service	D
HCM 2000 Volume to Capacity ratio	0.61		
Actuated Cycle Length (s)	140.0	Sum of lost time (s)	13.5
Intersection Capacity Utilization	59.4%	ICU Level of Service	B
Analysis Period (min)	15		

c Critical Lane Group

HCM Signalized Intersection Capacity Analysis
3: Old Columbia Pike & National Drive

Cheng Property
AM Background

												
Movement	EBL	EBT	EBR	WBL	WBT	WBR	NBL	NBT	NBR	SBL	SBT	SBR
Lane Configurations												
Traffic Volume (vph)	47	6	150	116	0	1	149	134	134	10	645	72
Future Volume (vph)	47	6	150	116	0	1	149	134	134	10	645	72
Ideal Flow (vphpl)	1900	1900	1900	1900	1900	1900	1900	1900	1900	1900	1900	1900
Total Lost time (s)		4.5	4.5	4.5	4.5		4.5	4.5	4.5	4.5	4.5	4.5
Lane Util. Factor		1.00	1.00	1.00	1.00		1.00	0.91	1.00	1.00	0.91	1.00
Frt		1.00	0.85	1.00	0.85		1.00	1.00	0.85	1.00	1.00	0.85
Flt Protected		0.96	1.00	0.95	1.00		0.95	1.00	1.00	0.95	1.00	1.00
Satd. Flow (prot)		1784	1583	1770	1583		1770	5085	1583	1770	5085	1583
Flt Permitted		0.76	1.00	0.72	1.00		0.37	1.00	1.00	0.66	1.00	1.00
Satd. Flow (perm)		1415	1583	1340	1583		696	5085	1583	1221	5085	1583
Peak-hour factor, PHF	0.92	0.92	0.92	0.92	0.92	0.92	0.92	0.92	0.92	0.92	0.92	0.92
Adj. Flow (vph)	51	7	163	126	0	1	162	146	146	11	701	78
RTOR Reduction (vph)	0	0	136	0	1	0	0	0	43	0	0	23
Lane Group Flow (vph)	0	58	27	126	0	0	162	146	103	11	701	55
Turn Type	Perm	NA	Perm	Perm	NA		Perm	NA	Perm	Perm	NA	Perm
Protected Phases		4			8			2			6	
Permitted Phases	4		4	8			2		2	6		6
Actuated Green, G (s)		11.5	11.5	11.5	11.5		49.5	49.5	49.5	49.5	49.5	49.5
Effective Green, g (s)		11.5	11.5	11.5	11.5		49.5	49.5	49.5	49.5	49.5	49.5
Actuated g/C Ratio		0.16	0.16	0.16	0.16		0.71	0.71	0.71	0.71	0.71	0.71
Clearance Time (s)		4.5	4.5	4.5	4.5		4.5	4.5	4.5	4.5	4.5	4.5
Vehicle Extension (s)		3.0	3.0	3.0	3.0		3.0	3.0	3.0	3.0	3.0	3.0
Lane Grp Cap (vph)		232	260	220	260		492	3595	1119	863	3595	1119
v/s Ratio Prot					0.00			0.03			0.14	
v/s Ratio Perm		0.04	0.02	c0.09			c0.23		0.07	0.01		0.03
v/c Ratio		0.25	0.10	0.57	0.00		0.33	0.04	0.09	0.01	0.19	0.05
Uniform Delay, d1		25.5	24.9	27.0	24.4		3.9	3.1	3.2	3.0	3.5	3.1
Progression Factor		1.00	1.00	1.00	1.00		2.88	1.59	6.77	1.00	1.00	1.00
Incremental Delay, d2		0.6	0.2	3.6	0.0		1.5	0.0	0.1	0.0	0.1	0.1
Delay (s)		26.1	25.0	30.6	24.4		12.8	4.9	21.9	3.1	3.6	3.2
Level of Service		C	C	C	C		B	A	C	A	A	A
Approach Delay (s)		25.3			30.5			13.2			3.6	
Approach LOS		C			C			B			A	
Intersection Summary												
HCM 2000 Control Delay			11.5				HCM 2000 Level of Service				B	
HCM 2000 Volume to Capacity ratio			0.38									
Actuated Cycle Length (s)			70.0				Sum of lost time (s)				9.0	
Intersection Capacity Utilization			45.1%				ICU Level of Service				A	
Analysis Period (min)			15									

c Critical Lane Group

HCM Signalized Intersection Capacity Analysis
4: Old Columbia Pike & MD 198

Cheng Property
AM Background

Movement	EBL	EBT	EBR	WBL	WBT	WBR	NBL	NBT	NBR	SBL	SBT	SBR
Lane Configurations												
Traffic Volume (vph)	12	835	87	281	962	6	112	6	239	12	7	4
Future Volume (vph)	12	835	87	281	962	6	112	6	239	12	7	4
Ideal Flow (vphpl)	1900	1900	1900	1900	1900	1900	1900	1900	1900	1900	1900	1900
Total Lost time (s)	4.5	4.5		4.5	4.5		4.5	4.5	4.5	4.5	4.5	
Lane Util. Factor	1.00	0.95		1.00	0.95		1.00	1.00	1.00	1.00	1.00	
Frt	1.00	0.99		1.00	1.00		1.00	1.00	0.85	1.00	0.95	
Flt Protected	0.95	1.00		0.95	1.00		0.95	1.00	1.00	0.95	1.00	
Satd. Flow (prot)	1770	3489		1770	3536		1770	1863	1583	1770	1770	
Flt Permitted	0.26	1.00		0.22	1.00		0.75	1.00	1.00	0.75	1.00	
Satd. Flow (perm)	493	3489		404	3536		1397	1863	1583	1403	1770	
Peak-hour factor, PHF	0.92	0.92	0.92	0.92	0.92	0.92	0.92	0.92	0.92	0.92	0.92	0.92
Adj. Flow (vph)	13	908	95	305	1046	7	122	7	260	13	8	4
RTOR Reduction (vph)	0	5	0	0	0	0	0	0	213	0	3	0
Lane Group Flow (vph)	13	998	0	305	1053	0	122	7	47	13	9	0
Turn Type	pm+pt	NA		pm+pt	NA		Perm	NA	Perm	Perm	NA	
Protected Phases	7	4		3	8			2			6	
Permitted Phases	4			8			2		2	6		
Actuated Green, G (s)	89.3	86.9		105.5	98.6		25.5	25.5	25.5	25.5	25.5	
Effective Green, g (s)	89.3	86.9		105.5	98.6		25.5	25.5	25.5	25.5	25.5	
Actuated g/C Ratio	0.64	0.62		0.75	0.70		0.18	0.18	0.18	0.18	0.18	
Clearance Time (s)	4.5	4.5		4.5	4.5		4.5	4.5	4.5	4.5	4.5	
Vehicle Extension (s)	3.0	3.0		3.0	3.0		3.0	3.0	3.0	3.0	3.0	
Lane Grp Cap (vph)	336	2165		442	2490		254	339	288	255	322	
v/s Ratio Prot	0.00	0.29		c0.07	0.30			0.00			0.00	
v/s Ratio Perm	0.02			c0.45			c0.09		0.03	0.01		
v/c Ratio	0.04	0.46		0.69	0.42		0.48	0.02	0.16	0.05	0.03	
Uniform Delay, d1	9.3	14.1		9.2	8.7		51.3	47.0	48.3	47.3	47.1	
Progression Factor	1.00	1.00		0.96	0.76		1.00	1.00	1.00	1.00	1.00	
Incremental Delay, d2	0.0	0.7		3.9	0.4		6.4	0.1	1.2	0.4	0.2	
Delay (s)	9.3	14.8		12.7	7.1		57.7	47.1	49.5	47.6	47.2	
Level of Service	A	B		B	A		E	D	D	D	D	
Approach Delay (s)		14.7			8.3			52.0			47.4	
Approach LOS		B			A			D			D	
Intersection Summary												
HCM 2000 Control Delay			17.1			HCM 2000 Level of Service			B			
HCM 2000 Volume to Capacity ratio			0.66									
Actuated Cycle Length (s)			140.0			Sum of lost time (s)		13.5				
Intersection Capacity Utilization			65.5%			ICU Level of Service			C			
Analysis Period (min)			15									

c Critical Lane Group

HCM Unsignalized Intersection Capacity Analysis

5: Blackburn Road & US 29 SB Off Ramp



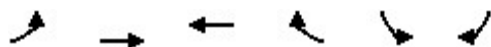

















Cheng Property
AM Background



Movement	EBL	EBT	WBT	WBR	SBL	SBR
Lane Configurations		↑	↑		↘	
Traffic Volume (veh/h)	0	33	49	0	61	4
Future Volume (Veh/h)	0	33	49	0	61	4
Sign Control		Free	Free		Stop	
Grade		0%	0%		0%	
Peak Hour Factor	0.92	0.92	0.92	0.92	0.92	0.92
Hourly flow rate (vph)	0	36	53	0	66	4
Pedestrians						
Lane Width (ft)						
Walking Speed (ft/s)						
Percent Blockage						
Right turn flare (veh)						
Median type		None	None			
Median storage (veh)						
Upstream signal (ft)						
pX, platoon unblocked						
vC, conflicting volume	53				89	53
vC1, stage 1 conf vol						
vC2, stage 2 conf vol						
vCu, unblocked vol	53				89	53
tC, single (s)	4.1				6.4	6.2
tC, 2 stage (s)						
tF (s)	2.2				3.5	3.3
p0 queue free %	100				93	100
cM capacity (veh/h)	1553				912	1014
Direction, Lane #	EB 1	WB 1	SB 1			
Volume Total	36	53	70			
Volume Left	0	0	66			
Volume Right	0	0	4			
cSH	1700	1700	917			
Volume to Capacity	0.02	0.03	0.08			
Queue Length 95th (ft)	0	0	6			
Control Delay (s)	0.0	0.0	9.3			
Lane LOS			A			
Approach Delay (s)	0.0	0.0	9.3			
Approach LOS			A			
Intersection Summary						
Average Delay			4.1			
Intersection Capacity Utilization			13.6%	ICU Level of Service	A	
Analysis Period (min)			15			

HCM Unsignalized Intersection Capacity Analysis
6: Lions Den Drive/Burtonsville Drive & MD 198

Cheng Property
AM Background

												
Movement	EBL	EBT	EBR	WBL	WBT	WBR	NBL	NBT	NBR	SBL	SBT	SBR
Lane Configurations												
Traffic Volume (veh/h)	0	910	6	3	1082	3	10	0	19	5	1	8
Future Volume (Veh/h)	0	910	6	3	1082	3	10	0	19	5	1	8
Sign Control		Free			Free			Stop			Stop	
Grade		0%			0%			0%			0%	
Peak Hour Factor	0.92	0.92	0.92	0.92	0.92	0.92	0.92	0.92	0.92	0.92	0.92	0.92
Hourly flow rate (vph)	0	989	7	3	1176	3	11	0	21	5	1	9
Pedestrians												
Lane Width (ft)												
Walking Speed (ft/s)												
Percent Blockage												
Right turn flare (veh)												
Median type	None					None						
Median storage (veh)												
Upstream signal (ft)												
pX, platoon unblocked												
vC, conflicting volume	1179		996			2180		2174	989	2194	2180	1178
vC1, stage 1 conf vol												
vC2, stage 2 conf vol												
vCu, unblocked vol	1179		996			2180		2174	989	2194	2180	1178
tC, single (s)	4.1		4.1			7.1		6.5	6.2	7.1	6.5	6.2
tC, 2 stage (s)												
tF (s)	2.2		2.2			3.5		4.0	3.3	3.5	4.0	3.3
p0 queue free %	100		100			65		100	93	83	98	96
cM capacity (veh/h)	592		695			31		46	299	30	46	233
Direction, Lane #	EB 1	EB 2	EB 3	WB 1	WB 2	NB 1	SB 1					
Volume Total	0	989	7	3	1179	32	15					
Volume Left	0	0	0	3	0	11	5					
Volume Right	0	0	7	0	3	21	9					
cSH	1700	1700	1700	695	1700	76	66					
Volume to Capacity	0.00	0.58	0.00	0.00	0.69	0.42	0.23					
Queue Length 95th (ft)	0	0	0	0	0	42	20					
Control Delay (s)	0.0	0.0	0.0	10.2	0.0	83.5	74.7					
Lane LOS				B	F			F				
Approach Delay (s)	0.0			0.0			83.5	74.7				
Approach LOS						F	F					
Intersection Summary												
Average Delay			1.7									
Intersection Capacity Utilization			67.1%			ICU Level of Service		C				
Analysis Period (min)			15									

HCM Signalized Intersection Capacity Analysis

7: Old Columbia Pike & Greencastle Road

Cheng Property
AM Background



Movement	EBL	EBT	EBR	WBL	WBT	WBR	NBL	NBT	NBR	SBL	SBT	SBR
Lane Configurations		↕			↕			↕	↕		↕	
Traffic Volume (vph)	9	14	6	177	13	65	2	253	130	64	355	13
Future Volume (vph)	9	14	6	177	13	65	2	253	130	64	355	13
Ideal Flow (vphpl)	1900	1900	1900	1900	1900	1900	1900	1900	1900	1900	1900	1900
Total Lost time (s)		4.5			4.5			4.5	4.5		4.5	
Lane Util. Factor		1.00			1.00			1.00	1.00		1.00	
Frt		0.97			0.97			1.00	0.85		1.00	
Flt Protected		0.98			0.97			1.00	1.00		0.99	
Satd. Flow (prot)		1780			1738			1862	1583		1842	
Flt Permitted		0.89			0.77			1.00	1.00		0.92	
Satd. Flow (perm)		1604			1390			1859	1583		1704	
Peak-hour factor, PHF	0.92	0.92	0.92	0.92	0.92	0.92	0.92	0.92	0.92	0.92	0.92	0.92
Adj. Flow (vph)	10	15	7	192	14	71	2	275	141	70	386	14
RTOR Reduction (vph)	0	5	0	0	26	0	0	0	64	0	1	0
Lane Group Flow (vph)	0	27	0	0	251	0	0	277	77	0	469	0
Turn Type	Perm	NA		Perm	NA		Perm	NA	Perm	Perm	NA	
Protected Phases		2			6			4			8	
Permitted Phases	2			6			4		4	8		
Actuated Green, G (s)		13.9			13.9			27.3	27.3		27.3	
Effective Green, g (s)		13.9			13.9			27.3	27.3		27.3	
Actuated g/C Ratio		0.28			0.28			0.54	0.54		0.54	
Clearance Time (s)		4.5			4.5			4.5	4.5		4.5	
Vehicle Extension (s)		3.0			3.0			3.0	3.0		3.0	
Lane Grp Cap (vph)		444			384			1010	860		926	
v/s Ratio Prot												
v/s Ratio Perm		0.02			c0.18			0.15	0.05		c0.28	
v/c Ratio		0.06			0.65			0.27	0.09		0.51	
Uniform Delay, d1		13.3			16.0			6.1	5.5		7.2	
Progression Factor		1.00			1.00			1.00	1.00		1.00	
Incremental Delay, d2		0.1			4.0			0.7	0.2		2.0	
Delay (s)		13.4			20.0			6.8	5.7		9.2	
Level of Service		B			B			A	A		A	
Approach Delay (s)		13.4			20.0			6.4			9.2	
Approach LOS		B			B			A			A	





















Intersection Summary

HCM 2000 Control Delay	10.8	HCM 2000 Level of Service	B
HCM 2000 Volume to Capacity ratio	0.56		
Actuated Cycle Length (s)	50.2	Sum of lost time (s)	9.0
Intersection Capacity Utilization	68.8%	ICU Level of Service	C
Analysis Period (min)	15		

c Critical Lane Group

HCM Unsignalized Intersection Capacity Analysis
 8: Site Access/Shopping Center & MD 198

Cheng Property
 AM Background

												
Movement	EBL	EBT	EBR	WBL	WBT	WBR	NBL	NBT	NBR	SBL	SBT	SBR
Lane Configurations												
Traffic Volume (veh/h)	93	917	59	65	1250	46	7	0	17	15	3	89
Future Volume (Veh/h)	93	917	59	65	1250	46	7	0	17	15	3	89
Sign Control		Free			Free			Stop			Stop	
Grade		0%			0%			0%			0%	
Peak Hour Factor	0.92	0.92	0.92	0.92	0.92	0.92	0.92	0.92	0.92	0.92	0.92	0.92
Hourly flow rate (vph)	101	997	64	71	1359	50	8	0	18	16	3	97
Pedestrians												
Lane Width (ft)												
Walking Speed (ft/s)												
Percent Blockage												
Right turn flare (veh)												
Median type												
		None			None							
Median storage (veh)												
Upstream signal (ft)												
		1205			528							
pX, platoon unblocked	0.83			0.90			0.88	0.88	0.90	0.88	0.88	0.83
vC, conflicting volume	1409			1061			2151	2782	530	2220	2764	680
vC1, stage 1 conf vol												
vC2, stage 2 conf vol												
vCu, unblocked vol	1072			846			1516	2237	257	1595	2217	188
tC, single (s)	4.1			4.1			7.5	6.5	6.9	7.5	6.5	6.9
tC, 2 stage (s)												
tF (s)	2.2			2.2			3.5	4.0	3.3	3.5	4.0	3.3
p0 queue free %	81			90			82	100	97	67	89	86
cM capacity (veh/h)	533			708			45	27	668	48	28	679
Direction, Lane #	EB 1	EB 2	EB 3	WB 1	WB 2	WB 3	WB 4	NB 1	SB 1	SB 2		
Volume Total	101	665	396	71	680	680	50	26	19	97		
Volume Left	101	0	0	71	0	0	0	8	16	0		
Volume Right	0	0	64	0	0	0	50	18	0	97		
cSH	533	1700	1700	708	1700	1700	1700	126	43	679		
Volume to Capacity	0.19	0.39	0.23	0.10	0.40	0.40	0.03	0.21	0.44	0.14		
Queue Length 95th (ft)	17	0	0	8	0	0	0	18	39	12		
Control Delay (s)	13.3	0.0	0.0	10.6	0.0	0.0	0.0	40.7	142.8	11.2		
Lane LOS	B			B				E	F	B		
Approach Delay (s)	1.2			0.5				40.7	32.7			
Approach LOS								E	D			
Intersection Summary												
Average Delay			2.5									
Intersection Capacity Utilization			57.6%		ICU Level of Service				B			
Analysis Period (min)			15									

HCM Unsignalized Intersection Capacity Analysis
9: Site Access & MD 198

























Cheng Property
AM Background



Movement	EBT	EBR	WBL	WBT	NBL	NBR	
Lane Configurations	↑↑↑			↑↑↑		↑	
Traffic Volume (veh/h)	985	2	0	1361	0	81	
Future Volume (Veh/h)	985	2	0	1361	0	81	
Sign Control	Free			Free	Stop		
Grade	0%			0%	0%		
Peak Hour Factor	0.92	0.92	0.92	0.92	0.92	0.92	
Hourly flow rate (vph)	1071	2	0	1479	0	88	
Pedestrians							
Lane Width (ft)							
Walking Speed (ft/s)							
Percent Blockage							
Right turn flare (veh)							
Median type	None			None			
Median storage (veh)							
Upstream signal (ft)	279						
pX, platoon unblocked					0.84		
vC, conflicting volume				1073	1565	358	
vC1, stage 1 conf vol							
vC2, stage 2 conf vol							
vCu, unblocked vol				1073	1024	358	
tC, single (s)				4.1	6.8	6.9	
tC, 2 stage (s)							
tF (s)				2.2	3.5	3.3	
p0 queue free %				100	100	86	
cM capacity (veh/h)				645	195	638	
Direction, Lane #	EB 1	EB 2	EB 3	WB 1	WB 2	WB 3	NB 1
Volume Total	428	428	216	493	493	493	88
Volume Left	0	0	0	0	0	0	0
Volume Right	0	0	2	0	0	0	88
cSH	1700	1700	1700	1700	1700	1700	638
Volume to Capacity	0.25	0.25	0.13	0.29	0.29	0.29	0.14
Queue Length 95th (ft)	0	0	0	0	0	0	12
Control Delay (s)	0.0	0.0	0.0	0.0	0.0	0.0	11.5
Lane LOS							B
Approach Delay (s)	0.0			0.0			11.5
Approach LOS							B
Intersection Summary							
Average Delay				0.4			
Intersection Capacity Utilization	30.8%			ICU Level of Service			A
Analysis Period (min)	15						

HCM Signalized Intersection Capacity Analysis
 1: US 29 NB Off Ramp/US 29 NB On Ramp & MD 198

Cheng Property
 AM Total

												
Movement	EBL	EBT	EBR	WBL	WBT	WBR	NBL	NBT	NBR	SBL	SBT	SBR
Lane Configurations	 	  			  							
Traffic Volume (vph)	256	930	0	0	1373	217	189	0	292	0	0	0
Future Volume (vph)	256	930	0	0	1373	217	189	0	292	0	0	0
Ideal Flow (vphpl)	1900	1900	1900	1900	1900	1900	1900	1900	1900	1900	1900	1900
Total Lost time (s)	4.5	4.5			4.5	4.5	4.5	4.5	4.5			
Lane Util. Factor	0.97	0.91			0.91	1.00	0.95	0.95	1.00			
Frt	1.00	1.00			1.00	0.85	1.00	1.00	0.85			
Flt Protected	0.95	1.00			1.00	1.00	0.95	0.95	1.00			
Satd. Flow (prot)	3433	5085			5085	1583	1681	1681	1583			
Flt Permitted	0.95	1.00			1.00	1.00	0.95	0.95	1.00			
Satd. Flow (perm)	3433	5085			5085	1583	1681	1681	1583			
Peak-hour factor, PHF	0.92	0.92	0.92	0.92	0.92	0.92	0.92	0.92	0.92	0.92	0.92	0.92
Adj. Flow (vph)	278	1011	0	0	1492	236	205	0	317	0	0	0
RTOR Reduction (vph)	0	0	0	0	0	94	0	0	154	0	0	0
Lane Group Flow (vph)	278	1011	0	0	1492	142	102	103	163	0	0	0
Turn Type	Prot	NA			NA	Perm	Perm	NA	Perm			
Protected Phases	7	4			8			2				
Permitted Phases						8	2		2			
Actuated Green, G (s)	16.6	105.5			84.4	84.4	25.5	25.5	25.5			
Effective Green, g (s)	16.6	105.5			84.4	84.4	25.5	25.5	25.5			
Actuated g/C Ratio	0.12	0.75			0.60	0.60	0.18	0.18	0.18			
Clearance Time (s)	4.5	4.5			4.5	4.5	4.5	4.5	4.5			
Vehicle Extension (s)	3.0	3.0			3.0	3.0	3.0	3.0	3.0			
Lane Grp Cap (vph)	407	3831			3065	954	306	306	288			
v/s Ratio Prot	c0.08	0.20			c0.29							
v/s Ratio Perm						0.09	0.06	0.06	c0.10			
v/c Ratio	0.68	0.26			0.49	0.15	0.33	0.34	0.57			
Uniform Delay, d1	59.2	5.3			15.6	12.1	49.8	49.9	52.2			
Progression Factor	0.76	2.92			1.00	1.00	1.00	1.00	1.00			
Incremental Delay, d2	4.5	0.2			0.6	0.3	2.9	3.0	7.9			
Delay (s)	49.8	15.7			16.2	12.5	52.8	52.8	60.1			
Level of Service	D	B			B	B	D	D	E			
Approach Delay (s)		23.0			15.7			57.2			0.0	
Approach LOS		C			B			E			A	
Intersection Summary												
HCM 2000 Control Delay			24.5		HCM 2000 Level of Service				C			
HCM 2000 Volume to Capacity ratio			0.53									
Actuated Cycle Length (s)			140.0		Sum of lost time (s)				13.5			
Intersection Capacity Utilization			50.3%		ICU Level of Service				A			
Analysis Period (min)			15									

c Critical Lane Group

HCM Signalized Intersection Capacity Analysis

2: Old Columbia Pike & MD 198

Cheng Property
AM Total



Movement	EBL	EBT	EBR	WBL	WBT	WBR	NBL	NBT	NBR	SBL	SBT	SBR
Lane Configurations												
Traffic Volume (vph)	176	801	99	278	922	216	0	0	0	323	138	432
Future Volume (vph)	176	801	99	278	922	216	0	0	0	323	138	432
Ideal Flow (vphpl)	1900	1900	1900	1900	1900	1900	1900	1900	1900	1900	1900	1900
Total Lost time (s)	4.5	4.5		4.5	4.5	4.5				4.5	4.5	4.5
Lane Util. Factor	1.00	0.91		0.97	0.95	1.00				0.86	0.86	1.00
Frt	1.00	0.98		1.00	1.00	0.85				1.00	1.00	0.85
Flt Protected	0.95	1.00		0.95	1.00	1.00				0.95	0.98	1.00
Satd. Flow (prot)	1770	5001		3433	3539	1583				3044	3139	1583
Flt Permitted	0.95	1.00		0.95	1.00	1.00				0.95	0.98	1.00
Satd. Flow (perm)	1770	5001		3433	3539	1583				3044	3139	1583
Peak-hour factor, PHF	0.92	0.92	0.92	0.92	0.92	0.92	0.92	0.92	0.92	0.92	0.92	0.92
Adj. Flow (vph)	191	871	108	302	1002	235	0	0	0	351	150	470
RTOR Reduction (vph)	0	10	0	0	0	108	0	0	0	0	0	202
Lane Group Flow (vph)	191	969	0	302	1002	127	0	0	0	246	255	268
Turn Type	Prot	NA		Prot	NA	Perm				Perm	NA	Perm
Protected Phases	7	4		3	8						6	
Permitted Phases						8				6		6
Actuated Green, G (s)	15.5	73.4		17.6	75.5	75.5				35.5	35.5	35.5
Effective Green, g (s)	15.5	73.4		17.6	75.5	75.5				35.5	35.5	35.5
Actuated g/C Ratio	0.11	0.52		0.13	0.54	0.54				0.25	0.25	0.25
Clearance Time (s)	4.5	4.5		4.5	4.5	4.5				4.5	4.5	4.5
Vehicle Extension (s)	3.0	3.0		3.0	3.0	3.0				3.0	3.0	3.0
Lane Grp Cap (vph)	195	2621		431	1908	853				771	795	401
v/s Ratio Prot	c0.11	0.19		0.09	c0.28							
v/s Ratio Perm						0.08				0.08	0.08	c0.17
v/c Ratio	0.98	0.37		0.70	0.53	0.15				0.32	0.32	0.67
Uniform Delay, d1	62.1	19.7		58.7	20.7	16.2				42.4	42.5	46.9
Progression Factor	0.78	1.51		0.80	1.55	6.96				0.95	0.95	0.91
Incremental Delay, d2	55.0	0.4		4.6	0.9	0.3				1.1	1.0	8.4
Delay (s)	103.6	30.1		51.7	33.1	112.7				41.4	41.4	51.1
Level of Service	F	C		D	C	F				D	D	D
Approach Delay (s)		42.1			48.9			0.0			46.1	
Approach LOS		D			D			A			D	

Intersection Summary























HCM 2000 Control Delay	46.0	HCM 2000 Level of Service	D
HCM 2000 Volume to Capacity ratio	0.62		
Actuated Cycle Length (s)	140.0	Sum of lost time (s)	13.5
Intersection Capacity Utilization	59.7%	ICU Level of Service	B
Analysis Period (min)	15		

c Critical Lane Group

HCM Signalized Intersection Capacity Analysis

3: Old Columbia Pike & National Drive

Cheng Property
AM Total























												
Movement	EBL	EBT	EBR	WBL	WBT	WBR	NBL	NBT	NBR	SBL	SBT	SBR
Lane Configurations												
Traffic Volume (vph)	47	6	150	116	0	1	149	136	134	10	648	72
Future Volume (vph)	47	6	150	116	0	1	149	136	134	10	648	72
Ideal Flow (vphpl)	1900	1900	1900	1900	1900	1900	1900	1900	1900	1900	1900	1900
Total Lost time (s)		4.5	4.5	4.5	4.5		4.5	4.5	4.5	4.5	4.5	4.5
Lane Util. Factor		1.00	1.00	1.00	1.00		1.00	0.91	1.00	1.00	0.91	1.00
Frt		1.00	0.85	1.00	0.85		1.00	1.00	0.85	1.00	1.00	0.85
Flt Protected		0.96	1.00	0.95	1.00		0.95	1.00	1.00	0.95	1.00	1.00
Satd. Flow (prot)		1784	1583	1770	1583		1770	5085	1583	1770	5085	1583
Flt Permitted		0.76	1.00	0.72	1.00		0.37	1.00	1.00	0.65	1.00	1.00
Satd. Flow (perm)		1415	1583	1340	1583		694	5085	1583	1218	5085	1583
Peak-hour factor, PHF	0.92	0.92	0.92	0.92	0.92	0.92	0.92	0.92	0.92	0.92	0.92	0.92
Adj. Flow (vph)	51	7	163	126	0	1	162	148	146	11	704	78
RTOR Reduction (vph)	0	0	136	0	1	0	0	0	43	0	0	23
Lane Group Flow (vph)	0	58	27	126	0	0	162	148	103	11	704	55
Turn Type	Perm	NA	Perm	Perm	NA		Perm	NA	Perm	Perm	NA	Perm
Protected Phases		4			8			2			6	
Permitted Phases	4		4	8			2		2	6		6
Actuated Green, G (s)		11.5	11.5	11.5	11.5		49.5	49.5	49.5	49.5	49.5	49.5
Effective Green, g (s)		11.5	11.5	11.5	11.5		49.5	49.5	49.5	49.5	49.5	49.5
Actuated g/C Ratio		0.16	0.16	0.16	0.16		0.71	0.71	0.71	0.71	0.71	0.71
Clearance Time (s)		4.5	4.5	4.5	4.5		4.5	4.5	4.5	4.5	4.5	4.5
Vehicle Extension (s)		3.0	3.0	3.0	3.0		3.0	3.0	3.0	3.0	3.0	3.0
Lane Grp Cap (vph)		232	260	220	260		490	3595	1119	861	3595	1119
v/s Ratio Prot					0.00			0.03			0.14	
v/s Ratio Perm		0.04	0.02	c0.09			c0.23		0.07	0.01		0.03
v/c Ratio		0.25	0.10	0.57	0.00		0.33	0.04	0.09	0.01	0.20	0.05
Uniform Delay, d1		25.5	24.9	27.0	24.4		3.9	3.1	3.2	3.0	3.5	3.1
Progression Factor		1.00	1.00	1.00	1.00		2.90	1.60	6.81	1.00	1.00	1.00
Incremental Delay, d2		0.6	0.2	3.6	0.0		1.5	0.0	0.1	0.0	0.1	0.1
Delay (s)		26.1	25.0	30.6	24.4		12.9	5.0	22.0	3.1	3.6	3.2
Level of Service		C	C	C	C		B	A	C	A	A	A
Approach Delay (s)		25.3			30.5			13.2			3.6	
Approach LOS		C			C			B			A	
Intersection Summary												
HCM 2000 Control Delay			11.5				HCM 2000 Level of Service				B	
HCM 2000 Volume to Capacity ratio			0.38									
Actuated Cycle Length (s)			70.0				Sum of lost time (s)				9.0	
Intersection Capacity Utilization			45.1%				ICU Level of Service				A	
Analysis Period (min)			15									

c Critical Lane Group

HCM Signalized Intersection Capacity Analysis

4: Old Columbia Pike & MD 198

Cheng Property
AM Total

												
Movement	EBL	EBT	EBR	WBL	WBT	WBR	NBL	NBT	NBR	SBL	SBT	SBR
Lane Configurations												
Traffic Volume (vph)	12	839	87	283	967	6	112	6	241	12	7	4
Future Volume (vph)	12	839	87	283	967	6	112	6	241	12	7	4
Ideal Flow (vphpl)	1900	1900	1900	1900	1900	1900	1900	1900	1900	1900	1900	1900
Total Lost time (s)	4.5	4.5		4.5	4.5		4.5	4.5	4.5	4.5	4.5	
Lane Util. Factor	1.00	0.95		1.00	0.95		1.00	1.00	1.00	1.00	1.00	
Frt	1.00	0.99		1.00	1.00		1.00	1.00	0.85	1.00	0.95	
Flt Protected	0.95	1.00		0.95	1.00		0.95	1.00	1.00	0.95	1.00	
Satd. Flow (prot)	1770	3489		1770	3536		1770	1863	1583	1770	1770	
Flt Permitted	0.26	1.00		0.22	1.00		0.75	1.00	1.00	0.75	1.00	
Satd. Flow (perm)	491	3489		401	3536		1397	1863	1583	1403	1770	
Peak-hour factor, PHF	0.92	0.92	0.92	0.92	0.92	0.92	0.92	0.92	0.92	0.92	0.92	0.92
Adj. Flow (vph)	13	912	95	308	1051	7	122	7	262	13	8	4
RTOR Reduction (vph)	0	5	0	0	0	0	0	0	214	0	3	0
Lane Group Flow (vph)	13	1002	0	308	1058	0	122	7	48	13	9	0
Turn Type	pm+pt	NA		pm+pt	NA		Perm	NA	Perm	Perm	NA	
Protected Phases	7	4		3	8			2				6
Permitted Phases	4			8			2		2	6		
Actuated Green, G (s)	89.1	86.7		105.5	98.6		25.5	25.5	25.5	25.5	25.5	
Effective Green, g (s)	89.1	86.7		105.5	98.6		25.5	25.5	25.5	25.5	25.5	
Actuated g/C Ratio	0.64	0.62		0.75	0.70		0.18	0.18	0.18	0.18	0.18	
Clearance Time (s)	4.5	4.5		4.5	4.5		4.5	4.5	4.5	4.5	4.5	
Vehicle Extension (s)	3.0	3.0		3.0	3.0		3.0	3.0	3.0	3.0	3.0	
Lane Grp Cap (vph)	334	2160		442	2490		254	339	288	255	322	
v/s Ratio Prot	0.00	0.29		c0.07	0.30			0.00			0.00	
v/s Ratio Perm	0.02			c0.45			c0.09		0.03	0.01		
v/c Ratio	0.04	0.46		0.70	0.42		0.48	0.02	0.17	0.05	0.03	
Uniform Delay, d1	9.3	14.2		9.4	8.7		51.3	47.0	48.3	47.3	47.1	
Progression Factor	1.00	1.00		4.70	0.62		1.00	1.00	1.00	1.00	1.00	
Incremental Delay, d2	0.0	0.7		3.7	0.4		6.4	0.1	1.2	0.4	0.2	
Delay (s)	9.4	15.0		47.7	5.8		57.7	47.1	49.5	47.6	47.2	
Level of Service	A	B		D	A		E	D	D	D	D	
Approach Delay (s)		14.9			15.3			52.0			47.4	
Approach LOS		B			B			D			D	
Intersection Summary												
HCM 2000 Control Delay			20.5				HCM 2000 Level of Service			C		
HCM 2000 Volume to Capacity ratio			0.67									
Actuated Cycle Length (s)			140.0				Sum of lost time (s)			13.5		
Intersection Capacity Utilization			65.8%				ICU Level of Service			C		
Analysis Period (min)			15									

c Critical Lane Group

HCM Unsignalized Intersection Capacity Analysis
5: Blackburn Road & US 29 SB Off Ramp



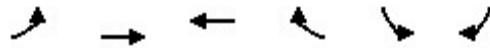

















Cheng Property
AM Total



Movement	EBL	EBT	WBT	WBR	SBL	SBR
Lane Configurations		↑	↑		↘	↘
Traffic Volume (veh/h)	0	33	49	0	61	4
Future Volume (Veh/h)	0	33	49	0	61	4
Sign Control		Free	Free		Stop	
Grade		0%	0%		0%	
Peak Hour Factor	0.92	0.92	0.92	0.92	0.92	0.92
Hourly flow rate (vph)	0	36	53	0	66	4
Pedestrians						
Lane Width (ft)						
Walking Speed (ft/s)						
Percent Blockage						
Right turn flare (veh)						
Median type		None	None			
Median storage (veh)						
Upstream signal (ft)						
pX, platoon unblocked						
vC, conflicting volume	53				89	53
vC1, stage 1 conf vol						
vC2, stage 2 conf vol						
vCu, unblocked vol	53				89	53
tC, single (s)	4.1				6.4	6.2
tC, 2 stage (s)						
tF (s)	2.2				3.5	3.3
p0 queue free %	100				93	100
cM capacity (veh/h)	1553				912	1014
Direction, Lane #	EB 1	WB 1	SB 1			
Volume Total	36	53	70			
Volume Left	0	0	66			
Volume Right	0	0	4			
cSH	1700	1700	917			
Volume to Capacity	0.02	0.03	0.08			
Queue Length 95th (ft)	0	0	6			
Control Delay (s)	0.0	0.0	9.3			
Lane LOS			A			
Approach Delay (s)	0.0	0.0	9.3			
Approach LOS			A			
Intersection Summary						
Average Delay			4.1			
Intersection Capacity Utilization			13.6%		ICU Level of Service	A
Analysis Period (min)			15			

HCM Unsignalized Intersection Capacity Analysis
6: Lions Den Drive/Burtonsville Drive & MD 198

















Cheng Property
AM Total

												
Movement	EBL	EBT	EBR	WBL	WBT	WBR	NBL	NBT	NBR	SBL	SBT	SBR
Lane Configurations												
Traffic Volume (veh/h)	0	914	6	3	1087	3	10	0	19	5	1	8
Future Volume (Veh/h)	0	914	6	3	1087	3	10	0	19	5	1	8
Sign Control		Free			Free			Stop			Stop	
Grade		0%			0%			0%			0%	
Peak Hour Factor	0.92	0.92	0.92	0.92	0.92	0.92	0.92	0.92	0.92	0.92	0.92	0.92
Hourly flow rate (vph)	0	993	7	3	1182	3	11	0	21	5	1	9
Pedestrians												
Lane Width (ft)												
Walking Speed (ft/s)												
Percent Blockage												
Right turn flare (veh)												
Median type												
		None			None							
Median storage (veh)												
Upstream signal (ft)												
pX, platoon unblocked												
vC, conflicting volume	1185			1000			2190	2184	993	2204	2190	1184
vC1, stage 1 conf vol												
vC2, stage 2 conf vol												
vCu, unblocked vol	1185			1000			2190	2184	993	2204	2190	1184
tC, single (s)	4.1			4.1			7.1	6.5	6.2	7.1	6.5	6.2
tC, 2 stage (s)												
tF (s)	2.2			2.2			3.5	4.0	3.3	3.5	4.0	3.3
p0 queue free %	100			100			64	100	93	83	98	96
cM capacity (veh/h)	589			692			31	46	298	30	45	231
Direction, Lane #	EB 1	EB 2	EB 3	WB 1	WB 2	NB 1	SB 1					
Volume Total	0	993	7	3	1185	32	15					
Volume Left	0	0	0	3	0	11	5					
Volume Right	0	0	7	0	3	21	9					
cSH	1700	1700	1700	692	1700	75	65					
Volume to Capacity	0.00	0.58	0.00	0.00	0.70	0.43	0.23					
Queue Length 95th (ft)	0	0	0	0	0	43	20					
Control Delay (s)	0.0	0.0	0.0	10.2	0.0	85.4	76.1					
Lane LOS				B		F	F					
Approach Delay (s)	0.0			0.0		85.4	76.1					
Approach LOS						F	F					
Intersection Summary												
Average Delay			1.7									
Intersection Capacity Utilization		67.4%		ICU Level of Service		C						
Analysis Period (min)		15										

HCM Signalized Intersection Capacity Analysis

7: Old Columbia Pike & Greencastle Road





















Cheng Property
AM Total

													
Movement	EBL	EBT	EBR	WBL	WBT	WBR	NBL	NBT	NBR	SBL	SBT	SBR	
Lane Configurations													
Traffic Volume (vph)	9	14	6	177	13	65	2	255	130	64	357	13	
Future Volume (vph)	9	14	6	177	13	65	2	255	130	64	357	13	
Ideal Flow (vphpl)	1900	1900	1900	1900	1900	1900	1900	1900	1900	1900	1900	1900	
Total Lost time (s)		4.5			4.5			4.5	4.5		4.5		
Lane Util. Factor		1.00			1.00			1.00	1.00		1.00		
Frt		0.97			0.97			1.00	0.85		1.00		
Flt Protected		0.98			0.97			1.00	1.00		0.99		
Satd. Flow (prot)		1780			1738			1862	1583		1842		
Flt Permitted		0.89			0.77			1.00	1.00		0.92		
Satd. Flow (perm)		1604			1390			1859	1583		1704		
Peak-hour factor, PHF	0.92	0.92	0.92	0.92	0.92	0.92	0.92	0.92	0.92	0.92	0.92	0.92	
Adj. Flow (vph)	10	15	7	192	14	71	2	277	141	70	388	14	
RTOR Reduction (vph)	0	5	0	0	26	0	0	0	64	0	1	0	
Lane Group Flow (vph)	0	27	0	0	251	0	0	279	77	0	471	0	
Turn Type	Perm	NA		Perm	NA		Perm	NA	Perm	Perm	NA		
Protected Phases		2			6			4			8		
Permitted Phases	2			6			4		4	8			
Actuated Green, G (s)		13.9			13.9			27.3	27.3		27.3		
Effective Green, g (s)		13.9			13.9			27.3	27.3		27.3		
Actuated g/C Ratio		0.28			0.28			0.54	0.54		0.54		
Clearance Time (s)		4.5			4.5			4.5	4.5		4.5		
Vehicle Extension (s)		3.0			3.0			3.0	3.0		3.0		
Lane Grp Cap (vph)		444			384			1010	860		926		
v/s Ratio Prot													
v/s Ratio Perm		0.02			c0.18			0.15	0.05		c0.28		
v/c Ratio		0.06			0.65			0.28	0.09		0.51		
Uniform Delay, d1		13.3			16.0			6.1	5.5		7.2		
Progression Factor		1.00			1.00			1.00	1.00		1.00		
Incremental Delay, d2		0.1			4.0			0.7	0.2		2.0		
Delay (s)		13.4			20.0			6.8	5.7		9.2		
Level of Service		B			B			A	A		A		
Approach Delay (s)		13.4			20.0			6.4			9.2		
Approach LOS		B			B			A			A		
Intersection Summary													
HCM 2000 Control Delay			10.8									HCM 2000 Level of Service	B
HCM 2000 Volume to Capacity ratio			0.56										
Actuated Cycle Length (s)			50.2									Sum of lost time (s)	9.0
Intersection Capacity Utilization			69.0%									ICU Level of Service	C
Analysis Period (min)			15										

c Critical Lane Group

HCM Signalized Intersection Capacity Analysis
8: Site Access/Shopping Center & MD 198

Cheng Property
AM Total

												
Movement	EBL	EBT	EBR	WBL	WBT	WBR	NBL	NBT	NBR	SBL	SBT	SBR
Lane Configurations												
Traffic Volume (vph)	93	878	104	128	1197	46	67	2	32	15	5	89
Future Volume (vph)	93	878	104	128	1197	46	67	2	32	15	5	89
Ideal Flow (vphpl)	1900	1900	1900	1900	1900	1900	1900	1900	1900	1900	1900	1900
Total Lost time (s)	4.5	4.5		4.5	4.5	4.5		4.5	4.5		4.5	4.5
Lane Util. Factor	1.00	0.95		1.00	0.95	1.00		1.00	1.00		1.00	1.00
Frt	1.00	0.98		1.00	1.00	0.85		1.00	0.85		1.00	0.85
Flt Protected	0.95	1.00		0.95	1.00	1.00		0.95	1.00		0.96	1.00
Satd. Flow (prot)	1770	3483		1770	3539	1583		1776	1583		1794	1583
Flt Permitted	0.12	1.00		0.18	1.00	1.00		0.95	1.00		0.96	1.00
Satd. Flow (perm)	221	3483		328	3539	1583		1776	1583		1794	1583
Peak-hour factor, PHF	0.92	0.92	0.92	0.92	0.92	0.92	0.92	0.92	0.92	0.92	0.92	0.92
Adj. Flow (vph)	101	954	113	139	1301	50	73	2	35	16	5	97
RTOR Reduction (vph)	0	6	0	0	0	23	0	0	30	0	0	84
Lane Group Flow (vph)	101	1061	0	139	1301	27	0	75	5	0	21	13
Turn Type	pm+pt	NA		pm+pt	NA	Perm	Split	NA	Perm	Split	NA	Perm
Protected Phases	7	4		3	8		2	2		6	6	
Permitted Phases	4			8		8			2			6
Actuated Green, G (s)	83.7	75.2		86.3	76.5	76.5		18.5	18.5		18.5	18.5
Effective Green, g (s)	83.7	75.2		86.3	76.5	76.5		18.5	18.5		18.5	18.5
Actuated g/C Ratio	0.60	0.54		0.62	0.55	0.55		0.13	0.13		0.13	0.13
Clearance Time (s)	4.5	4.5		4.5	4.5	4.5		4.5	4.5		4.5	4.5
Vehicle Extension (s)	3.0	3.0		3.0	3.0	3.0		3.0	3.0		3.0	3.0
Lane Grp Cap (vph)	226	1870		303	1933	864		234	209		237	209
v/s Ratio Prot	0.03	0.30		c0.03	c0.37			c0.04			c0.01	
v/s Ratio Perm	0.24			0.25		0.02			0.00			0.01
v/c Ratio	0.45	0.57		0.46	0.67	0.03		0.32	0.02		0.09	0.06
Uniform Delay, d1	17.3	21.6		14.6	22.8	14.7		55.1	52.9		53.3	53.2
Progression Factor	1.68	0.71		2.34	2.10	13.89		1.00	1.00		1.00	1.00
Incremental Delay, d2	1.3	1.1		0.9	1.5	0.1		3.6	0.2		0.7	0.6
Delay (s)	30.3	16.4		34.9	49.4	203.7		58.6	53.1		54.1	53.7
Level of Service	C	B		C	D	F		E	D		D	D
Approach Delay (s)		17.6			53.2			56.9			53.8	
Approach LOS		B			D			E			D	
Intersection Summary												
HCM 2000 Control Delay			39.0	HCM 2000 Level of Service				D				
HCM 2000 Volume to Capacity ratio			0.52									
Actuated Cycle Length (s)			140.0	Sum of lost time (s)				18.0				
Intersection Capacity Utilization			60.0%	ICU Level of Service				B				
Analysis Period (min)			15									

c Critical Lane Group

























HCM Unsignalized Intersection Capacity Analysis
 9: Site Access & MD 198

Cheng Property
 AM Total

	→	↘	↙	←	↖	↗	
Movement	EBT	EBR	WBL	WBT	NBL	NBR	
Lane Configurations	↑↑↑			↑↑↑		↗	
Traffic Volume (veh/h)	987	16	0	1371	0	128	
Future Volume (Veh/h)	987	16	0	1371	0	128	
Sign Control	Free			Free	Stop		
Grade	0%			0%	0%		
Peak Hour Factor	0.92	0.92	0.92	0.92	0.92	0.92	
Hourly flow rate (vph)	1073	17	0	1490	0	139	
Pedestrians							
Lane Width (ft)							
Walking Speed (ft/s)							
Percent Blockage							
Right turn flare (veh)							
Median type	None			None			
Median storage (veh)							
Upstream signal (ft)	249			279			
pX, platoon unblocked				0.85	0.92	0.85	
vC, conflicting volume				1090	1578	366	
vC1, stage 1 conf vol							
vC2, stage 2 conf vol							
vCu, unblocked vol				475	199	0	
tC, single (s)				4.1	6.8	6.9	
tC, 2 stage (s)							
tF (s)				2.2	3.5	3.3	
p0 queue free %				100	100	85	
cM capacity (veh/h)				918	709	919	
Direction, Lane #	EB 1	EB 2	EB 3	WB 1	WB 2	WB 3	NB 1
Volume Total	429	429	232	497	497	497	139
Volume Left	0	0	0	0	0	0	0
Volume Right	0	0	17	0	0	0	139
cSH	1700	1700	1700	1700	1700	1700	919
Volume to Capacity	0.25	0.25	0.14	0.29	0.29	0.29	0.15
Queue Length 95th (ft)	0	0	0	0	0	0	13
Control Delay (s)	0.0	0.0	0.0	0.0	0.0	0.0	9.6
Lane LOS							
Approach Delay (s)	0.0			0.0			
Approach LOS							
Intersection Summary							
Average Delay				0.5			
Intersection Capacity Utilization				34.0%	ICU Level of Service		A
Analysis Period (min)	15						

HCM Signalized Intersection Capacity Analysis
 1: US 29 NB Off Ramp/US 29 NB On Ramp & MD 198



























Cheng Property
 PM Existing

													
Movement	EBL	EBT	EBR	WBL	WBT	WBR	NBL	NBT	NBR	SBL	SBT	SBR	
Lane Configurations	 	  			  								
Traffic Volume (vph)	269	1123	0	0	1127	516	228	5	436	0	0	0	
Future Volume (vph)	269	1123	0	0	1127	516	228	5	436	0	0	0	
Ideal Flow (vphpl)	1900	1900	1900	1900	1900	1900	1900	1900	1900	1900	1900	1900	
Total Lost time (s)	4.5	4.5			4.5	4.5	4.5	4.5	4.5				
Lane Util. Factor	0.97	0.91			0.91	1.00	0.95	0.95	1.00				
Frt	1.00	1.00			1.00	0.85	1.00	1.00	0.85				
Flt Protected	0.95	1.00			1.00	1.00	0.95	0.95	1.00				
Satd. Flow (prot)	3433	5085			5085	1583	1681	1689	1583				
Flt Permitted	0.95	1.00			1.00	1.00	0.95	0.95	1.00				
Satd. Flow (perm)	3433	5085			5085	1583	1681	1689	1583				
Peak-hour factor, PHF	0.92	0.92	0.92	0.92	0.92	0.92	0.92	0.92	0.92	0.92	0.92	0.92	
Adj. Flow (vph)	292	1221	0	0	1225	561	248	5	474	0	0	0	
RTOR Reduction (vph)	0	0	0	0	0	255	0	0	89	0	0	0	
Lane Group Flow (vph)	292	1221	0	0	1225	306	126	127	385	0	0	0	
Turn Type	Prot	NA			NA	Perm	Perm	NA	Perm				
Protected Phases	7	4			8			2					
Permitted Phases						8	2		2				
Actuated Green, G (s)	15.5	85.5			65.5	65.5	25.5	25.5	25.5				
Effective Green, g (s)	15.5	85.5			65.5	65.5	25.5	25.5	25.5				
Actuated g/C Ratio	0.13	0.71			0.55	0.55	0.21	0.21	0.21				
Clearance Time (s)	4.5	4.5			4.5	4.5	4.5	4.5	4.5				
Vehicle Extension (s)	3.0	3.0			3.0	3.0	3.0	3.0	3.0				
Lane Grp Cap (vph)	443	3623			2775	864	357	358	336				
v/s Ratio Prot	c0.09	0.24			c0.24								
v/s Ratio Perm						0.19	0.07	0.08	c0.24				
v/c Ratio	0.66	0.34			0.44	0.35	0.35	0.35	1.15				
Uniform Delay, d1	49.7	6.5			16.3	15.3	40.2	40.2	47.2				
Progression Factor	0.78	1.20			1.00	1.00	1.00	1.00	1.00				
Incremental Delay, d2	3.4	0.2			0.5	1.1	2.7	2.7	94.8				
Delay (s)	42.1	8.1			16.8	16.5	43.0	43.0	142.0				
Level of Service	D	A			B	B	D	D	F				
Approach Delay (s)		14.6			16.7			107.6			0.0		
Approach LOS		B			B			F			A		
Intersection Summary													
HCM 2000 Control Delay			32.3		HCM 2000 Level of Service				C				
HCM 2000 Volume to Capacity ratio			0.64										
Actuated Cycle Length (s)			120.0		Sum of lost time (s)				13.5				
Intersection Capacity Utilization			57.3%		ICU Level of Service				B				
Analysis Period (min)			15										

c Critical Lane Group

HCM Signalized Intersection Capacity Analysis
2: Old Columbia Pike & MD 198























Cheng Property
PM Existing

												
Movement	EBL	EBT	EBR	WBL	WBT	WBR	NBL	NBT	NBR	SBL	SBT	SBR
Lane Configurations		  		 	 					 	 	
Traffic Volume (vph)	130	862	94	296	836	181	0	0	0	413	179	556
Future Volume (vph)	130	862	94	296	836	181	0	0	0	413	179	556
Ideal Flow (vphpl)	1900	1900	1900	1900	1900	1900	1900	1900	1900	1900	1900	1900
Total Lost time (s)	4.5	4.5	4.5	4.5	4.5	4.5				4.5	4.5	4.5
Lane Util. Factor	1.00	0.91	1.00	0.97	0.95	1.00				0.86	0.86	1.00
Frt	1.00	1.00	0.85	1.00	1.00	0.85				1.00	1.00	0.85
Flt Protected	0.95	1.00	1.00	0.95	1.00	1.00				0.95	0.98	1.00
Satd. Flow (prot)	1770	5085	1583	3433	3539	1583				3044	3141	1583
Flt Permitted	0.95	1.00	1.00	0.95	1.00	1.00				0.95	0.98	1.00
Satd. Flow (perm)	1770	5085	1583	3433	3539	1583				3044	3141	1583
Peak-hour factor, PHF	0.92	0.92	0.92	0.92	0.92	0.92	0.92	0.92	0.92	0.92	0.92	0.92
Adj. Flow (vph)	141	937	102	322	909	197	0	0	0	449	195	604
RTOR Reduction (vph)	0	0	69	0	0	130	0	0	0	0	0	213
Lane Group Flow (vph)	141	937	33	322	909	67	0	0	0	319	325	391
Turn Type	Prot	NA	Perm	Prot	NA	Perm				Perm	NA	Perm
Protected Phases	7	4		3	8						6	
Permitted Phases			4			8				6		6
Actuated Green, G (s)	14.8	39.2	39.2	16.5	40.9	40.9				50.8	50.8	50.8
Effective Green, g (s)	14.8	39.2	39.2	16.5	40.9	40.9				50.8	50.8	50.8
Actuated g/C Ratio	0.12	0.33	0.33	0.14	0.34	0.34				0.42	0.42	0.42
Clearance Time (s)	4.5	4.5	4.5	4.5	4.5	4.5				4.5	4.5	4.5
Vehicle Extension (s)	3.0	3.0	3.0	3.0	3.0	3.0				3.0	3.0	3.0
Lane Grp Cap (vph)	218	1661	517	472	1206	539				1288	1329	670
v/s Ratio Prot	0.08	0.18		c0.09	c0.26							
v/s Ratio Perm			0.02			0.04				0.10	0.10	c0.25
v/c Ratio	0.65	0.56	0.06	0.68	0.75	0.12				0.25	0.24	0.58
Uniform Delay, d1	50.1	33.3	27.8	49.3	35.1	27.2				22.3	22.3	26.5
Progression Factor	1.35	0.65	0.23	0.80	0.97	4.34				1.00	1.00	1.00
Incremental Delay, d2	5.8	0.4	0.0	3.7	2.5	0.1				0.5	0.4	3.7
Delay (s)	73.4	22.0	6.5	43.3	36.6	118.1				22.7	22.7	30.2
Level of Service	E	C	A	D	D	F				C	C	C
Approach Delay (s)		26.8			49.3			0.0			26.3	
Approach LOS		C			D			A			C	
Intersection Summary												
HCM 2000 Control Delay			35.0		HCM 2000 Level of Service					C		
HCM 2000 Volume to Capacity ratio			0.67									
Actuated Cycle Length (s)			120.0		Sum of lost time (s)				13.5			
Intersection Capacity Utilization			65.0%		ICU Level of Service				C			
Analysis Period (min)			15									

c Critical Lane Group

HCM Signalized Intersection Capacity Analysis
3: Old Columbia Pike & National Drive

Cheng Property
PM Existing























												
Movement	EBL	EBT	EBR	WBL	WBT	WBR	NBL	NBT	NBR	SBL	SBT	SBR
Lane Configurations												
Traffic Volume (vph)	74	2	298	55	21	34	186	133	20	9	796	127
Future Volume (vph)	74	2	298	55	21	34	186	133	20	9	796	127
Ideal Flow (vphpl)	1900	1900	1900	1900	1900	1900	1900	1900	1900	1900	1900	1900
Total Lost time (s)		4.5	4.5	4.5	4.5		4.5	4.5	4.5	4.5	4.5	4.5
Lane Util. Factor		1.00	1.00	1.00	1.00		1.00	0.91	1.00	1.00	0.91	1.00
Frt		1.00	0.85	1.00	0.91		1.00	1.00	0.85	1.00	1.00	0.85
Flt Protected		0.95	1.00	0.95	1.00		0.95	1.00	1.00	0.95	1.00	1.00
Satd. Flow (prot)		1776	1583	1770	1690		1770	5085	1583	1770	5085	1583
Flt Permitted		0.69	1.00	0.70	1.00		0.31	1.00	1.00	0.66	1.00	1.00
Satd. Flow (perm)		1282	1583	1311	1690		580	5085	1583	1222	5085	1583
Peak-hour factor, PHF	0.92	0.92	0.92	0.92	0.92	0.92	0.92	0.92	0.92	0.92	0.92	0.92
Adj. Flow (vph)	80	2	324	60	23	37	202	145	22	10	865	138
RTOR Reduction (vph)	0	0	118	0	30	0	0	0	7	0	0	42
Lane Group Flow (vph)	0	82	206	60	30	0	202	145	15	10	865	96
Turn Type	Perm	NA	Perm	Perm	NA		Perm	NA	Perm	Perm	NA	Perm
Protected Phases		4			8			2			6	
Permitted Phases	4		4	8			2		2	6		6
Actuated Green, G (s)		15.6	15.6	15.6	15.6		55.4	55.4	55.4	55.4	55.4	55.4
Effective Green, g (s)		15.6	15.6	15.6	15.6		55.4	55.4	55.4	55.4	55.4	55.4
Actuated g/C Ratio		0.19	0.19	0.19	0.19		0.69	0.69	0.69	0.69	0.69	0.69
Clearance Time (s)		4.5	4.5	4.5	4.5		4.5	4.5	4.5	4.5	4.5	4.5
Vehicle Extension (s)		3.0	3.0	3.0	3.0		3.0	3.0	3.0	3.0	3.0	3.0
Lane Grp Cap (vph)		249	308	255	329		401	3521	1096	846	3521	1096
v/s Ratio Prot					0.02			0.03			0.17	
v/s Ratio Perm		0.06	c0.13	0.05			c0.35		0.01	0.01		0.06
v/c Ratio		0.33	0.67	0.24	0.09		0.50	0.04	0.01	0.01	0.25	0.09
Uniform Delay, d1		27.7	29.8	27.2	26.4		5.8	3.9	3.8	3.8	4.6	4.0
Progression Factor		1.00	1.00	1.00	1.00		1.00	1.00	1.00	1.00	1.00	1.00
Incremental Delay, d2		0.8	5.4	0.5	0.1		4.5	0.0	0.0	0.0	0.2	0.2
Delay (s)		28.5	35.2	27.6	26.5		10.3	3.9	3.8	3.8	4.7	4.2
Level of Service		C	D	C	C		B	A	A	A	A	A
Approach Delay (s)		33.8			27.1			7.4			4.6	
Approach LOS		C			C			A			A	
Intersection Summary												
HCM 2000 Control Delay			12.8				HCM 2000 Level of Service				B	
HCM 2000 Volume to Capacity ratio			0.54									
Actuated Cycle Length (s)			80.0				Sum of lost time (s)				9.0	
Intersection Capacity Utilization			49.2%				ICU Level of Service				A	
Analysis Period (min)			15									

c Critical Lane Group

HCM Signalized Intersection Capacity Analysis

4: Old Columbia Pike & MD 198

Cheng Property
PM Existing

												
Movement	EBL	EBT	EBR	WBL	WBT	WBR	NBL	NBT	NBR	SBL	SBT	SBR
Lane Configurations												
Traffic Volume (vph)	14	841	80	430	967	24	83	12	283	36	29	7
Future Volume (vph)	14	841	80	430	967	24	83	12	283	36	29	7
Ideal Flow (vphpl)	1900	1900	1900	1900	1900	1900	1900	1900	1900	1900	1900	1900
Total Lost time (s)	4.5	4.5		4.5	4.5		4.5	4.5	4.5	4.5	4.5	
Lane Util. Factor	1.00	0.95		1.00	0.95		1.00	1.00	1.00	1.00	1.00	
Frt	1.00	0.99		1.00	1.00		1.00	1.00	0.85	1.00	0.97	
Flt Protected	0.95	1.00		0.95	1.00		0.95	1.00	1.00	0.95	1.00	
Satd. Flow (prot)	1770	3493		1770	3526		1770	1863	1583	1770	1807	
Flt Permitted	0.27	1.00		0.17	1.00		0.73	1.00	1.00	0.75	1.00	
Satd. Flow (perm)	494	3493		312	3526		1362	1863	1583	1395	1807	
Peak-hour factor, PHF	0.92	0.92	0.92	0.92	0.92	0.92	0.92	0.92	0.92	0.92	0.92	0.92
Adj. Flow (vph)	15	914	87	467	1051	26	90	13	308	39	32	8
RTOR Reduction (vph)	0	6	0	0	1	0	0	0	243	0	6	0
Lane Group Flow (vph)	15	995	0	467	1076	0	90	13	65	39	34	0
Turn Type	pm+pt	NA		pm+pt	NA		Perm	NA	Perm	Perm	NA	
Protected Phases	7	4		3	8			2			6	
Permitted Phases	4			8			2		2	6		
Actuated Green, G (s)	60.1	57.6		85.5	78.5		25.5	25.5	25.5	25.5	25.5	
Effective Green, g (s)	60.1	57.6		85.5	78.5		25.5	25.5	25.5	25.5	25.5	
Actuated g/C Ratio	0.50	0.48		0.71	0.65		0.21	0.21	0.21	0.21	0.21	
Clearance Time (s)	4.5	4.5		4.5	4.5		4.5	4.5	4.5	4.5	4.5	
Vehicle Extension (s)	3.0	3.0		3.0	3.0		3.0	3.0	3.0	3.0	3.0	
Lane Grp Cap (vph)	273	1676		506	2306		289	395	336	296	383	
v/s Ratio Prot	0.00	0.28		c0.18	0.31			0.01			0.02	
v/s Ratio Perm	0.03			c0.48			c0.07		0.04	0.03		
v/c Ratio	0.05	0.59		0.92	0.47		0.31	0.03	0.19	0.13	0.09	
Uniform Delay, d1	15.1	22.7		25.3	10.3		39.8	37.5	38.8	38.3	37.9	
Progression Factor	1.00	1.00		1.23	0.48		1.00	1.00	1.00	1.00	1.00	
Incremental Delay, d2	0.1	1.6		20.6	0.6		2.8	0.2	1.3	0.9	0.5	
Delay (s)	15.2	24.2		51.5	5.6		42.6	37.6	40.1	39.2	38.4	
Level of Service	B	C		D	A		D	D	D	D	D	
Approach Delay (s)		24.1			19.5			40.6			38.8	
Approach LOS		C			B			D			D	
Intersection Summary												
HCM 2000 Control Delay			24.4				HCM 2000 Level of Service			C		
HCM 2000 Volume to Capacity ratio			0.80									
Actuated Cycle Length (s)			120.0				Sum of lost time (s)			13.5		
Intersection Capacity Utilization			72.1%				ICU Level of Service			C		
Analysis Period (min)			15									

c Critical Lane Group

HCM Unsignalized Intersection Capacity Analysis
5: Blackburn Road & US 29 SB Off Ramp

Cheng Property
PM Existing

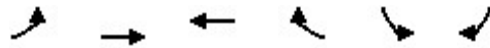

Movement	EBL	EBT	WBT	WBR	SBL	SBR
Lane Configurations		↑	↑		↘	↘
Traffic Volume (veh/h)	0	33	165	0	117	73
Future Volume (Veh/h)	0	33	165	0	117	73
Sign Control		Free	Free		Stop	
Grade		0%	0%		0%	
Peak Hour Factor	0.92	0.92	0.92	0.92	0.92	0.92
Hourly flow rate (vph)	0	36	179	0	127	79
Pedestrians						
Lane Width (ft)						
Walking Speed (ft/s)						
Percent Blockage						
Right turn flare (veh)						
Median type		None	None			
Median storage (veh)						
Upstream signal (ft)						
pX, platoon unblocked						
vC, conflicting volume	179			215	179	
vC1, stage 1 conf vol						
vC2, stage 2 conf vol						
vCu, unblocked vol	179			215	179	
tC, single (s)	4.1			6.4	6.2	
tC, 2 stage (s)						
tF (s)	2.2			3.5	3.3	
p0 queue free %	100			84	91	
cM capacity (veh/h)	1397			773	864	
Direction, Lane #	EB 1	WB 1	SB 1			
Volume Total	36	179	206			
Volume Left	0	0	127			
Volume Right	0	0	79			
cSH	1700	1700	806			
Volume to Capacity	0.02	0.11	0.26			
Queue Length 95th (ft)	0	0	25			
Control Delay (s)	0.0	0.0	11.0			
Lane LOS			B			
Approach Delay (s)	0.0	0.0	11.0			
Approach LOS			B			
Intersection Summary						
Average Delay			5.4			
Intersection Capacity Utilization			26.3%	ICU Level of Service	A	
Analysis Period (min)			15			

















HCM Unsignalized Intersection Capacity Analysis
6: Lions Den Drive/Burtonsville Drive & MD 198

Cheng Property
PM Existing

Movement	EBL	EBT	EBR	WBL	WBT	WBR	NBL	NBT	NBR	SBL	SBT	SBR												
Lane Configurations																								
Traffic Volume (veh/h)	1	905	8	17	1024	6	4	0	15	2	0	0												
Future Volume (Veh/h)	1	905	8	17	1024	6	4	0	15	2	0	0												
Sign Control	Free			Free			Stop			Stop														
Grade	0%			0%			0%			0%														
Peak Hour Factor	0.92	0.92	0.92	0.92	0.92	0.92	0.92	0.92	0.92	0.92	0.92	0.92												
Hourly flow rate (vph)	1	984	9	18	1113	7	4	0	16	2	0	0												
Pedestrians																								
Lane Width (ft)																								
Walking Speed (ft/s)																								
Percent Blockage																								
Right turn flare (veh)																								
Median type	None			None																				
Median storage (veh)																								
Upstream signal (ft)																								
pX, platoon unblocked																								
vC, conflicting volume	1120			993			2135			2142			984			2154			2148			1116		
vC1, stage 1 conf vol																								
vC2, stage 2 conf vol																								
vCu, unblocked vol	1120			993			2135			2142			984			2154			2148			1116		
tC, single (s)	4.1			4.1			7.1			6.5			6.2			7.1			6.5			6.2		
tC, 2 stage (s)																								
tF (s)	2.2			2.2			3.5			4.0			3.3			3.5			4.0			3.3		
p0 queue free %	100			97			89			100			95			94			100			100		
cM capacity (veh/h)	624			696			35			47			301			32			47			252		
Direction, Lane #	EB 1	EB 2	EB 3	WB 1	WB 2	NB 1	SB 1																	
Volume Total	1	984	9	18	1120	20	2																	
Volume Left	1	0	0	18	0	4	2																	
Volume Right	0	0	9	0	7	16	0																	
cSH	624	1700	1700	696	1700	119	32																	
Volume to Capacity	0.00	0.58	0.01	0.03	0.66	0.17	0.06																	
Queue Length 95th (ft)	0	0	0	2	0	14	5																	
Control Delay (s)	10.8	0.0	0.0	10.3	0.0	41.1	124.5																	
Lane LOS	B			B			E			F														
Approach Delay (s)	0.0			0.2			41.1			124.5														
Approach LOS							E			F														
Intersection Summary																								
Average Delay				0.6																				
Intersection Capacity Utilization				64.3%			ICU Level of Service						C											
Analysis Period (min)				15																				

HCM Signalized Intersection Capacity Analysis
7: Old Columbia Pike & Greencastle Road

Cheng Property
PM Existing

												
Movement	EBL	EBT	EBR	WBL	WBT	WBR	NBL	NBT	NBR	SBL	SBT	SBR
Lane Configurations												
Traffic Volume (vph)	15	10	3	55	11	109	6	239	71	162	501	25
Future Volume (vph)	15	10	3	55	11	109	6	239	71	162	501	25
Ideal Flow (vphpl)	1900	1900	1900	1900	1900	1900	1900	1900	1900	1900	1900	1900
Total Lost time (s)		4.5			4.5			4.5	4.5		4.5	
Lane Util. Factor		1.00			1.00			1.00	1.00		1.00	
Frt		0.99			0.92			1.00	0.85		1.00	
Flt Protected		0.97			0.98			1.00	1.00		0.99	
Satd. Flow (prot)		1790			1680			1860	1583		1832	
Flt Permitted		0.79			0.88			0.98	1.00		0.85	
Satd. Flow (perm)		1459			1507			1834	1583		1581	
Peak-hour factor, PHF	0.92	0.92	0.92	0.92	0.92	0.92	0.92	0.92	0.92	0.92	0.92	0.92
Adj. Flow (vph)	16	11	3	60	12	118	7	260	77	176	545	27
RTOR Reduction (vph)	0	3	0	0	100	0	0	0	27	0	1	0
Lane Group Flow (vph)	0	27	0	0	90	0	0	267	50	0	747	0
Turn Type	Perm	NA		Perm	NA		Perm	NA	Perm	Perm	NA	
Protected Phases		2			6			4			8	
Permitted Phases	2			6			4		4	8		
Actuated Green, G (s)		6.8			6.8			29.2	29.2		29.2	
Effective Green, g (s)		6.8			6.8			29.2	29.2		29.2	
Actuated g/C Ratio		0.15			0.15			0.65	0.65		0.65	
Clearance Time (s)		4.5			4.5			4.5	4.5		4.5	
Vehicle Extension (s)		3.0			3.0			3.0	3.0		3.0	
Lane Grp Cap (vph)		220			227			1190	1027		1025	
v/s Ratio Prot												
v/s Ratio Perm		0.02			c0.06			0.15	0.03		c0.47	
v/c Ratio		0.12			0.40			0.22	0.05		0.73	
Uniform Delay, d1		16.5			17.2			3.2	2.9		5.3	
Progression Factor		1.00			1.00			1.00	1.00		1.00	
Incremental Delay, d2		0.3			1.1			0.4	0.1		4.5	
Delay (s)		16.8			18.4			3.7	3.0		9.8	
Level of Service		B			B			A	A		A	
Approach Delay (s)		16.8			18.4			3.5			9.8	
Approach LOS		B			B			A			A	
Intersection Summary												
HCM 2000 Control Delay			9.6								HCM 2000 Level of Service	A
HCM 2000 Volume to Capacity ratio			0.66									
Actuated Cycle Length (s)			45.0								Sum of lost time (s)	9.0
Intersection Capacity Utilization			72.1%								ICU Level of Service	C
Analysis Period (min)			15									

c Critical Lane Group

HCM Unsignalized Intersection Capacity Analysis
 8: Site Access/Shopping Center & MD 198

Cheng Property
 PM Existing

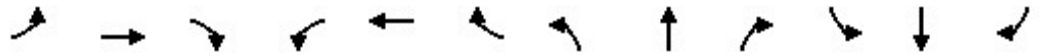

Movement	EBL	EBT	EBR	WBL	WBT	WBR	NBL	NBT	NBR	SBL	SBT	SBR
Lane Configurations												
Traffic Volume (veh/h)	164	1014	47	52	1161	127	6	1	13	25	9	180
Future Volume (Veh/h)	164	1014	47	52	1161	127	6	1	13	25	9	180
Sign Control		Free			Free			Stop			Stop	
Grade		0%			0%			0%			0%	
Peak Hour Factor	0.92	0.92	0.92	0.92	0.92	0.92	0.92	0.92	0.92	0.92	0.92	0.92
Hourly flow rate (vph)	178	1102	51	57	1262	138	7	1	14	27	10	196
Pedestrians												
Lane Width (ft)												
Walking Speed (ft/s)												
Percent Blockage												
Right turn flare (veh)												
Median type												
		None			None							
Median storage (veh)												
Upstream signal (ft)												
		1205			528							
pX, platoon unblocked	0.79			0.86			0.86	0.86	0.86	0.86	0.86	0.79
vC, conflicting volume	1400			1153			2430	2998	576	2298	2885	631
vC1, stage 1 conf vol												
vC2, stage 2 conf vol												
vCu, unblocked vol	976			847			1596	2255	175	1443	2125	4
tC, single (s)	4.1			4.1			7.5	6.5	6.9	7.5	6.5	6.9
tC, 2 stage (s)												
tF (s)	2.2			2.2			3.5	4.0	3.3	3.5	4.0	3.3
p0 queue free %	68			92			71	95	98	50	62	77
cM capacity (veh/h)	555			674			24	22	719	54	26	852
Direction, Lane #	EB 1	EB 2	EB 3	WB 1	WB 2	WB 3	WB 4	NB 1	SB 1	SB 2		
Volume Total	178	735	418	57	631	631	138	22	37	196		
Volume Left	178	0	0	57	0	0	0	7	27	0		
Volume Right	0	0	51	0	0	0	138	14	0	196		
cSH	555	1700	1700	674	1700	1700	1700	62	42	852		
Volume to Capacity	0.32	0.43	0.25	0.08	0.37	0.37	0.08	0.35	0.88	0.23		
Queue Length 95th (ft)	34	0	0	7	0	0	0	33	86	22		
Control Delay (s)	14.5	0.0	0.0	10.8	0.0	0.0	0.0	92.0	250.4	10.5		
Lane LOS	B			B				F	F	B		
Approach Delay (s)	1.9			0.4				92.0	48.6			
Approach LOS								F	E			
Intersection Summary												
Average Delay			5.4									
Intersection Capacity Utilization			57.9%		ICU Level of Service				B			
Analysis Period (min)			15									

HCM Unsignalized Intersection Capacity Analysis
 9: Site Access & MD 198

Cheng Property
 PM Existing



Movement	EBT	EBR	WBL	WBT	NBL	NBR	
Lane Configurations	↑↑↑			↑↑↑		↗	
Traffic Volume (veh/h)	1067	2	0	1337	0	86	
Future Volume (Veh/h)	1067	2	0	1337	0	86	
Sign Control	Free			Free	Stop		
Grade	0%			0%	0%		
Peak Hour Factor	0.92	0.92	0.92	0.92	0.92	0.92	
Hourly flow rate (vph)	1160	2	0	1453	0	93	
Pedestrians							
Lane Width (ft)							
Walking Speed (ft/s)							
Percent Blockage							
Right turn flare (veh)							
Median type	None			None			
Median storage (veh)							
Upstream signal (ft)	279						
pX, platoon unblocked					0.81		
vC, conflicting volume	1162			1645	388		
vC1, stage 1 conf vol							
vC2, stage 2 conf vol							
vCu, unblocked vol	1162			961	388		
tC, single (s)	4.1			6.8	6.9		
tC, 2 stage (s)							
tF (s)	2.2			3.5	3.3		
p0 queue free %	100			100	85		
cM capacity (veh/h)	597			205	611		
Direction, Lane #	EB 1	EB 2	EB 3	WB 1	WB 2	WB 3	NB 1
Volume Total	464	464	234	484	484	484	93
Volume Left	0	0	0	0	0	0	0
Volume Right	0	0	2	0	0	0	93
cSH	1700	1700	1700	1700	1700	1700	611
Volume to Capacity	0.27	0.27	0.14	0.28	0.28	0.28	0.15
Queue Length 95th (ft)	0	0	0	0	0	0	13
Control Delay (s)	0.0	0.0	0.0	0.0	0.0	0.0	11.9
Lane LOS							B
Approach Delay (s)	0.0			0.0			11.9
Approach LOS							B
Intersection Summary							
Average Delay	0.4						
Intersection Capacity Utilization	32.7%			ICU Level of Service			A
Analysis Period (min)	15						

HCM Signalized Intersection Capacity Analysis
 1: US 29 NB Off Ramp/US 29 NB On Ramp & MD 198

Cheng Property
 PM Background

Movement	EBL	EBT	EBR	WBL	WBT	WBR	NBL	NBT	NBR	SBL	SBT	SBR	
Lane Configurations													
Traffic Volume (vph)	269	1177	0	0	1280	516	228	5	436	0	0	0	
Future Volume (vph)	269	1177	0	0	1280	516	228	5	436	0	0	0	
Ideal Flow (vphpl)	1900	1900	1900	1900	1900	1900	1900	1900	1900	1900	1900	1900	
Total Lost time (s)	4.5	4.5			4.5	4.5	4.5	4.5	4.5				
Lane Util. Factor	0.97	0.91			0.91	1.00	0.95	0.95	1.00				
Frt	1.00	1.00			1.00	0.85	1.00	1.00	0.85				
Flt Protected	0.95	1.00			1.00	1.00	0.95	0.95	1.00				
Satd. Flow (prot)	3433	5085			5085	1583	1681	1689	1583				
Flt Permitted	0.95	1.00			1.00	1.00	0.95	0.95	1.00				
Satd. Flow (perm)	3433	5085			5085	1583	1681	1689	1583				
Peak-hour factor, PHF	0.92	0.92	0.92	0.92	0.92	0.92	0.92	0.92	0.92	0.92	0.92	0.92	
Adj. Flow (vph)	292	1279	0	0	1391	561	248	5	474	0	0	0	
RTOR Reduction (vph)	0	0	0	0	0	255	0	0	80	0	0	0	
Lane Group Flow (vph)	292	1279	0	0	1391	306	126	127	394	0	0	0	
Turn Type	Prot	NA			NA	Perm	Perm	NA	Perm				
Protected Phases	7	4			8			2					
Permitted Phases						8	2		2				
Actuated Green, G (s)	15.5	85.5			65.5	65.5	25.5	25.5	25.5				
Effective Green, g (s)	15.5	85.5			65.5	65.5	25.5	25.5	25.5				
Actuated g/C Ratio	0.13	0.71			0.55	0.55	0.21	0.21	0.21				
Clearance Time (s)	4.5	4.5			4.5	4.5	4.5	4.5	4.5				
Vehicle Extension (s)	3.0	3.0			3.0	3.0	3.0	3.0	3.0				
Lane Grp Cap (vph)	443	3623			2775	864	357	358	336				
v/s Ratio Prot	c0.09	0.25			c0.27								
v/s Ratio Perm						0.19	0.07	0.08	c0.25				
v/c Ratio	0.66	0.35			0.50	0.35	0.35	0.35	1.17				
Uniform Delay, d1	49.7	6.6			17.0	15.3	40.2	40.2	47.2				
Progression Factor	0.88	0.91			1.00	1.00	1.00	1.00	1.00				
Incremental Delay, d2	3.4	0.3			0.7	1.1	2.7	2.7	105.2				
Delay (s)	47.3	6.3			17.7	16.5	43.0	43.0	152.5				
Level of Service	D	A			B	B	D	D	F				
Approach Delay (s)		13.9			17.3			114.3			0.0		
Approach LOS		B			B			F			A		
Intersection Summary													
HCM 2000 Control Delay			32.7		HCM 2000 Level of Service				C				
HCM 2000 Volume to Capacity ratio			0.68										
Actuated Cycle Length (s)			120.0		Sum of lost time (s)				13.5				
Intersection Capacity Utilization			57.3%		ICU Level of Service				B				
Analysis Period (min)			15										

c Critical Lane Group

HCM Signalized Intersection Capacity Analysis

2: Old Columbia Pike & MD 198

Cheng Property
PM Background



Movement	EBL	EBT	EBR	WBL	WBT	WBR	NBL	NBT	NBR	SBL	SBT	SBR
Lane Configurations												
Traffic Volume (vph)	312	782	94	323	796	298	0	0	0	552	261	665
Future Volume (vph)	312	782	94	323	796	298	0	0	0	552	261	665
Ideal Flow (vphpl)	1900	1900	1900	1900	1900	1900	1900	1900	1900	1900	1900	1900
Total Lost time (s)	4.5	4.5	4.5	4.5	4.5	4.5				4.5	4.5	4.5
Lane Util. Factor	1.00	0.91	1.00	0.97	0.95	1.00				0.86	0.86	1.00
Frt	1.00	1.00	0.85	1.00	1.00	0.85				1.00	1.00	0.85
Flt Protected	0.95	1.00	1.00	0.95	1.00	1.00				0.95	0.98	1.00
Satd. Flow (prot)	1770	5085	1583	3433	3539	1583				3044	3147	1583
Flt Permitted	0.95	1.00	1.00	0.95	1.00	1.00				0.95	0.98	1.00
Satd. Flow (perm)	1770	5085	1583	3433	3539	1583				3044	3147	1583
Peak-hour factor, PHF	0.92	0.92	0.92	0.92	0.92	0.92	0.92	0.92	0.92	0.92	0.92	0.92
Adj. Flow (vph)	339	850	102	351	865	324	0	0	0	600	284	723
RTOR Reduction (vph)	0	0	65	0	0	216	0	0	0	0	0	233
Lane Group Flow (vph)	339	850	37	351	865	108	0	0	0	438	446	490
Turn Type	Prot	NA	Perm	Prot	NA	Perm				Perm	NA	Perm
Protected Phases	7	4		3	8						6	
Permitted Phases			4			8				6		6
Actuated Green, G (s)	20.5	43.1	43.1	17.5	40.1	40.1				45.9	45.9	45.9
Effective Green, g (s)	20.5	43.1	43.1	17.5	40.1	40.1				45.9	45.9	45.9
Actuated g/C Ratio	0.17	0.36	0.36	0.15	0.33	0.33				0.38	0.38	0.38
Clearance Time (s)	4.5	4.5	4.5	4.5	4.5	4.5				4.5	4.5	4.5
Vehicle Extension (s)	3.0	3.0	3.0	3.0	3.0	3.0				3.0	3.0	3.0
Lane Grp Cap (vph)	302	1826	568	500	1182	528				1164	1203	605
v/s Ratio Prot	c0.19	c0.17		0.10	c0.24							
v/s Ratio Perm			0.02			0.07				0.14	0.14	c0.31
v/c Ratio	1.12	0.47	0.06	0.70	0.73	0.21				0.38	0.37	0.81
Uniform Delay, d1	49.8	29.6	25.2	48.8	35.2	28.6				26.7	26.7	33.1
Progression Factor	1.25	0.59	0.26	0.77	1.03	5.98				1.00	1.00	1.00
Incremental Delay, d2	85.5	0.2	0.0	4.0	2.1	0.2				0.9	0.9	11.2
Delay (s)	147.7	17.7	6.6	41.7	38.3	171.1				27.7	27.5	44.3
Level of Service	F	B	A	D	D	F				C	C	D
Approach Delay (s)		50.9			67.0			0.0			35.1	
Approach LOS		D			E			A			D	

Intersection Summary

HCM 2000 Control Delay	50.8	HCM 2000 Level of Service	D
HCM 2000 Volume to Capacity ratio	0.83		
Actuated Cycle Length (s)	120.0	Sum of lost time (s)	13.5
Intersection Capacity Utilization	70.7%	ICU Level of Service	C
Analysis Period (min)	15		

c Critical Lane Group

HCM Signalized Intersection Capacity Analysis

3: Old Columbia Pike & National Drive

Cheng Property
PM Background



Movement	EBL	EBT	EBR	WBL	WBT	WBR	NBL	NBT	NBR	SBL	SBT	SBR
Lane Configurations		↖	↗	↖	↗		↖	↑↑↑	↗	↖	↑↑↑	↗
Traffic Volume (vph)	74	2	298	351	21	34	186	236	216	9	831	127
Future Volume (vph)	74	2	298	351	21	34	186	236	216	9	831	127
Ideal Flow (vphpl)	1900	1900	1900	1900	1900	1900	1900	1900	1900	1900	1900	1900
Total Lost time (s)		4.5	4.5	4.5	4.5		4.5	4.5	4.5	4.5	4.5	4.5
Lane Util. Factor		1.00	1.00	1.00	1.00		1.00	0.91	1.00	1.00	0.91	1.00
Frt		1.00	0.85	1.00	0.91		1.00	1.00	0.85	1.00	1.00	0.85
Flt Protected		0.95	1.00	0.95	1.00		0.95	1.00	1.00	0.95	1.00	1.00
Satd. Flow (prot)		1776	1583	1770	1690		1770	5085	1583	1770	5085	1583
Flt Permitted		0.72	1.00	0.70	1.00		0.28	1.00	1.00	0.59	1.00	1.00
Satd. Flow (perm)		1344	1583	1311	1690		527	5085	1583	1092	5085	1583
Peak-hour factor, PHF	0.92	0.92	0.92	0.92	0.92	0.92	0.92	0.92	0.92	0.92	0.92	0.92
Adj. Flow (vph)	80	2	324	382	23	37	202	257	235	10	903	138
RTOR Reduction (vph)	0	0	92	0	26	0	0	0	99	0	0	58
Lane Group Flow (vph)	0	82	232	382	34	0	202	257	136	10	903	80
Turn Type	Perm	NA	Perm	Perm	NA		Perm	NA	Perm	Perm	NA	Perm
Protected Phases		4			8			2			6	
Permitted Phases	4		4	8			2		2	6		6
Actuated Green, G (s)		24.8	24.8	24.8	24.8		46.2	46.2	46.2	46.2	46.2	46.2
Effective Green, g (s)		24.8	24.8	24.8	24.8		46.2	46.2	46.2	46.2	46.2	46.2
Actuated g/C Ratio		0.31	0.31	0.31	0.31		0.58	0.58	0.58	0.58	0.58	0.58
Clearance Time (s)		4.5	4.5	4.5	4.5		4.5	4.5	4.5	4.5	4.5	4.5
Vehicle Extension (s)		3.0	3.0	3.0	3.0		3.0	3.0	3.0	3.0	3.0	3.0
Lane Grp Cap (vph)		416	490	406	523		304	2936	914	630	2936	914
v/s Ratio Prot					0.02			0.05			0.18	
v/s Ratio Perm		0.06	0.15	c0.29			c0.38		0.09	0.01		0.05
v/c Ratio		0.20	0.47	0.94	0.07		0.66	0.09	0.15	0.02	0.31	0.09
Uniform Delay, d1		20.3	22.3	26.9	19.4		11.6	7.5	7.8	7.2	8.7	7.5
Progression Factor		1.00	1.00	1.00	1.00		1.00	1.00	1.00	1.00	1.00	1.00
Incremental Delay, d2		0.2	0.7	30.0	0.1		10.9	0.1	0.3	0.0	0.3	0.2
Delay (s)		20.5	23.0	56.9	19.5		22.5	7.6	8.2	7.3	9.0	7.7
Level of Service		C	C	E	B		C	A	A	A	A	A
Approach Delay (s)		22.5			51.8			12.1			8.8	
Approach LOS		C			D			B			A	

Intersection Summary

HCM 2000 Control Delay	19.2	HCM 2000 Level of Service	B
HCM 2000 Volume to Capacity ratio	0.76		
Actuated Cycle Length (s)	80.0	Sum of lost time (s)	9.0
Intersection Capacity Utilization	65.2%	ICU Level of Service	C
Analysis Period (min)	15		

c Critical Lane Group

HCM Signalized Intersection Capacity Analysis
4: Old Columbia Pike & MD 198

Cheng Property
PM Background

Movement	EBL	EBT	EBR	WBL	WBT	WBR	NBL	NBT	NBR	SBL	SBT	SBR
Lane Configurations												
Traffic Volume (vph)	14	892	80	465	1001	24	83	12	334	36	29	7
Future Volume (vph)	14	892	80	465	1001	24	83	12	334	36	29	7
Ideal Flow (vphpl)	1900	1900	1900	1900	1900	1900	1900	1900	1900	1900	1900	1900
Total Lost time (s)	4.5	4.5		4.5	4.5		4.5	4.5	4.5	4.5	4.5	
Lane Util. Factor	1.00	0.95		1.00	0.95		1.00	1.00	1.00	1.00	1.00	
Frt	1.00	0.99		1.00	1.00		1.00	1.00	0.85	1.00	0.97	
Flt Protected	0.95	1.00		0.95	1.00		0.95	1.00	1.00	0.95	1.00	
Satd. Flow (prot)	1770	3496		1770	3527		1770	1863	1583	1770	1807	
Flt Permitted	0.26	1.00		0.14	1.00		0.73	1.00	1.00	0.75	1.00	
Satd. Flow (perm)	477	3496		262	3527		1362	1863	1583	1395	1807	
Peak-hour factor, PHF	0.92	0.92	0.92	0.92	0.92	0.92	0.92	0.92	0.92	0.92	0.92	0.92
Adj. Flow (vph)	15	970	87	505	1088	26	90	13	363	39	32	8
RTOR Reduction (vph)	0	5	0	0	1	0	0	0	274	0	6	0
Lane Group Flow (vph)	15	1052	0	505	1113	0	90	13	89	39	34	0
Turn Type	pm+pt	NA		pm+pt	NA		Perm	NA	Perm	Perm	NA	
Protected Phases	7	4		3	8			2			6	
Permitted Phases	4			8			2		2	6		
Actuated Green, G (s)	58.0	55.5		85.5	78.5		25.5	25.5	25.5	25.5	25.5	
Effective Green, g (s)	58.0	55.5		85.5	78.5		25.5	25.5	25.5	25.5	25.5	
Actuated g/C Ratio	0.48	0.46		0.71	0.65		0.21	0.21	0.21	0.21	0.21	
Clearance Time (s)	4.5	4.5		4.5	4.5		4.5	4.5	4.5	4.5	4.5	
Vehicle Extension (s)	3.0	3.0		3.0	3.0		3.0	3.0	3.0	3.0	3.0	
Lane Grp Cap (vph)	257	1616		507	2307		289	395	336	296	383	
v/s Ratio Prot	0.00	0.30		c0.21	0.32			0.01			0.02	
v/s Ratio Perm	0.03			c0.50			c0.07		0.06	0.03		
v/c Ratio	0.06	0.65		1.00	0.48		0.31	0.03	0.26	0.13	0.09	
Uniform Delay, d1	16.2	24.8		30.9	10.5		39.8	37.5	39.4	38.3	37.9	
Progression Factor	1.00	1.00		1.33	0.59		1.00	1.00	1.00	1.00	1.00	
Incremental Delay, d2	0.1	2.0		35.3	0.6		2.8	0.2	1.9	0.9	0.5	
Delay (s)	16.2	26.8		76.4	6.8		42.6	37.6	41.3	39.2	38.4	
Level of Service	B	C		E	A		D	D	D	D	D	
Approach Delay (s)		26.7			28.5			41.5			38.8	
Approach LOS		C			C			D			D	
Intersection Summary												
HCM 2000 Control Delay			30.0			HCM 2000 Level of Service			C			
HCM 2000 Volume to Capacity ratio			0.86									
Actuated Cycle Length (s)			120.0			Sum of lost time (s)			13.5			
Intersection Capacity Utilization			75.5%			ICU Level of Service			D			
Analysis Period (min)			15									

c Critical Lane Group

HCM Unsignalized Intersection Capacity Analysis
5: Blackburn Road & US 29 SB Off Ramp



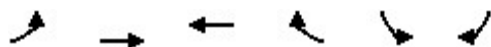

















Cheng Property
PM Background



Movement	EBL	EBT	WBT	WBR	SBL	SBR
Lane Configurations		↑	↑		↘	
Traffic Volume (veh/h)	0	33	165	0	117	73
Future Volume (Veh/h)	0	33	165	0	117	73
Sign Control		Free	Free		Stop	
Grade		0%	0%		0%	
Peak Hour Factor	0.92	0.92	0.92	0.92	0.92	0.92
Hourly flow rate (vph)	0	36	179	0	127	79
Pedestrians						
Lane Width (ft)						
Walking Speed (ft/s)						
Percent Blockage						
Right turn flare (veh)						
Median type		None	None			
Median storage (veh)						
Upstream signal (ft)						
pX, platoon unblocked						
vC, conflicting volume	179				215	179
vC1, stage 1 conf vol						
vC2, stage 2 conf vol						
vCu, unblocked vol	179				215	179
tC, single (s)	4.1				6.4	6.2
tC, 2 stage (s)						
tF (s)	2.2				3.5	3.3
p0 queue free %	100				84	91
cM capacity (veh/h)	1397				773	864
Direction, Lane #	EB 1	WB 1	SB 1			
Volume Total	36	179	206			
Volume Left	0	0	127			
Volume Right	0	0	79			
cSH	1700	1700	806			
Volume to Capacity	0.02	0.11	0.26			
Queue Length 95th (ft)	0	0	25			
Control Delay (s)	0.0	0.0	11.0			
Lane LOS			B			
Approach Delay (s)	0.0	0.0	11.0			
Approach LOS			B			
Intersection Summary						
Average Delay			5.4			
Intersection Capacity Utilization			26.3%		ICU Level of Service	A
Analysis Period (min)			15			

HCM Unsignalized Intersection Capacity Analysis
6: Lions Den Drive/Burtonsville Drive & MD 198

Cheng Property
PM Background

												
Movement	EBL	EBT	EBR	WBL	WBT	WBR	NBL	NBT	NBR	SBL	SBT	SBR
Lane Configurations												
Traffic Volume (veh/h)	1	956	8	17	1058	6	4	0	15	2	0	0
Future Volume (Veh/h)	1	956	8	17	1058	6	4	0	15	2	0	0
Sign Control		Free			Free			Stop			Stop	
Grade		0%			0%			0%			0%	
Peak Hour Factor	0.92	0.92	0.92	0.92	0.92	0.92	0.92	0.92	0.92	0.92	0.92	0.92
Hourly flow rate (vph)	1	1039	9	18	1150	7	4	0	16	2	0	0
Pedestrians												
Lane Width (ft)												
Walking Speed (ft/s)												
Percent Blockage												
Right turn flare (veh)												
Median type	None					None						
Median storage (veh)												
Upstream signal (ft)												
pX, platoon unblocked												
vC, conflicting volume	1157		1048			2227		2234	1039	2246	2240	1154
vC1, stage 1 conf vol												
vC2, stage 2 conf vol												
vCu, unblocked vol	1157		1048			2227		2234	1039	2246	2240	1154
tC, single (s)	4.1		4.1			7.1		6.5	6.2	7.1	6.5	6.2
tC, 2 stage (s)												
tF (s)	2.2		2.2			3.5		4.0	3.3	3.5	4.0	3.3
p0 queue free %	100		97			87		100	94	93	100	100
cM capacity (veh/h)	604		664			30		41	280	27	41	240
Direction, Lane #	EB 1	EB 2	EB 3	WB 1	WB 2	NB 1	SB 1					
Volume Total	1	1039	9	18	1157	20	2					
Volume Left	1	0	0	18	0	4	2					
Volume Right	0	0	9	0	7	16	0					
cSH	604	1700	1700	664	1700	105	27					
Volume to Capacity	0.00	0.61	0.01	0.03	0.68	0.19	0.07					
Queue Length 95th (ft)	0	0	0	2	0	17	6					
Control Delay (s)	11.0	0.0	0.0	10.6	0.0	47.1	146.4					
Lane LOS	B			B		E	F					
Approach Delay (s)	0.0			0.2		47.1	146.4					
Approach LOS						E	F					
Intersection Summary												
Average Delay			0.6									
Intersection Capacity Utilization			66.0%			ICU Level of Service		C				
Analysis Period (min)			15									

HCM Signalized Intersection Capacity Analysis

7: Old Columbia Pike & Greencastle Road

Cheng Property
PM Background























Movement	EBL	EBT	EBR	WBL	WBT	WBR	NBL	NBT	NBR	SBL	SBT	SBR	
Lane Configurations		↔			↔			↑	↗		↔		
Traffic Volume (vph)	15	10	3	55	11	109	6	290	71	162	536	25	
Future Volume (vph)	15	10	3	55	11	109	6	290	71	162	536	25	
Ideal Flow (vphpl)	1900	1900	1900	1900	1900	1900	1900	1900	1900	1900	1900	1900	
Total Lost time (s)		4.5			4.5			4.5	4.5		4.5		
Lane Util. Factor		1.00			1.00			1.00	1.00		1.00		
Frt		0.99			0.92			1.00	0.85		1.00		
Flt Protected		0.97			0.98			1.00	1.00		0.99		
Satd. Flow (prot)		1790			1680			1861	1583		1834		
Flt Permitted		0.79			0.88			0.99	1.00		0.84		
Satd. Flow (perm)		1459			1507			1837	1583		1565		
Peak-hour factor, PHF	0.92	0.92	0.92	0.92	0.92	0.92	0.92	0.92	0.92	0.92	0.92	0.92	
Adj. Flow (vph)	16	11	3	60	12	118	7	315	77	176	583	27	
RTOR Reduction (vph)	0	3	0	0	100	0	0	0	27	0	1	0	
Lane Group Flow (vph)	0	27	0	0	90	0	0	322	50	0	785	0	
Turn Type	Perm	NA		Perm	NA		Perm	NA	Perm	Perm	NA		
Protected Phases		2			6			4			8		
Permitted Phases	2			6			4		4	8			
Actuated Green, G (s)		6.8			6.8			29.2	29.2		29.2		
Effective Green, g (s)		6.8			6.8			29.2	29.2		29.2		
Actuated g/C Ratio		0.15			0.15			0.65	0.65		0.65		
Clearance Time (s)		4.5			4.5			4.5	4.5		4.5		
Vehicle Extension (s)		3.0			3.0			3.0	3.0		3.0		
Lane Grp Cap (vph)		220			227			1192	1027		1015		
v/s Ratio Prot													
v/s Ratio Perm		0.02			0.06			0.18	0.03		0.50		
v/c Ratio		0.12			0.40			0.27	0.05		0.77		
Uniform Delay, d1		16.5			17.2			3.4	2.9		5.6		
Progression Factor		1.00			1.00			1.00	1.00		1.00		
Incremental Delay, d2		0.3			1.1			0.6	0.1		5.7		
Delay (s)		16.8			18.4			3.9	3.0		11.3		
Level of Service		B			B			A	A		B		
Approach Delay (s)		16.8			18.4			3.7			11.3		
Approach LOS		B			B			A			B		
Intersection Summary													
HCM 2000 Control Delay			10.2									HCM 2000 Level of Service	B
HCM 2000 Volume to Capacity ratio			0.70										
Actuated Cycle Length (s)			45.0									Sum of lost time (s)	9.0
Intersection Capacity Utilization			76.6%									ICU Level of Service	D
Analysis Period (min)			15										

c Critical Lane Group

HCM Unsignalized Intersection Capacity Analysis
8: Site Access/Shopping Center & MD 198

Cheng Property
PM Background

												
Movement	EBL	EBT	EBR	WBL	WBT	WBR	NBL	NBT	NBR	SBL	SBT	SBR
Lane Configurations												
Traffic Volume (veh/h)	164	1116	47	52	1230	127	6	1	13	25	9	180
Future Volume (Veh/h)	164	1116	47	52	1230	127	6	1	13	25	9	180
Sign Control		Free			Free			Stop			Stop	
Grade		0%			0%			0%			0%	
Peak Hour Factor	0.92	0.92	0.92	0.92	0.92	0.92	0.92	0.92	0.92	0.92	0.92	0.92
Hourly flow rate (vph)	178	1213	51	57	1337	138	7	1	14	27	10	196
Pedestrians												
Lane Width (ft)												
Walking Speed (ft/s)												
Percent Blockage												
Right turn flare (veh)												
Median type												
		None			None							
Median storage (veh)												
Upstream signal (ft)												
		1205			528							
pX, platoon unblocked	0.80			0.83			0.89	0.89	0.83	0.89	0.89	0.80
vC, conflicting volume	1475			1264			2578	3184	632	2428	3071	668
vC1, stage 1 conf vol												
vC2, stage 2 conf vol												
vCu, unblocked vol	1100			896			1642	2323	131	1474	2196	95
tC, single (s)	4.1			4.1			7.5	6.5	6.9	7.5	6.5	6.9
tC, 2 stage (s)												
tF (s)	2.2			2.2			3.5	4.0	3.3	3.5	4.0	3.3
p0 queue free %	65			91			65	95	98	46	57	74
cM capacity (veh/h)	506			621			20	19	738	50	23	757
Direction, Lane #	EB 1	EB 2	EB 3	WB 1	WB 2	WB 3	WB 4	NB 1	SB 1	SB 2		
Volume Total	178	809	455	57	668	668	138	22	37	196		
Volume Left	178	0	0	57	0	0	0	7	27	0		
Volume Right	0	0	51	0	0	0	138	14	0	196		
cSH	506	1700	1700	621	1700	1700	1700	53	38	757		
Volume to Capacity	0.35	0.48	0.27	0.09	0.39	0.39	0.08	0.42	0.97	0.26		
Queue Length 95th (ft)	39	0	0	8	0	0	0	38	91	26		
Control Delay (s)	15.9	0.0	0.0	11.4	0.0	0.0	0.0	115.1	293.3	11.4		
Lane LOS	C			B				F	F	B		
Approach Delay (s)	2.0			0.4				115.1	56.2			
Approach LOS								F	F			
Intersection Summary												
Average Delay			5.9									
Intersection Capacity Utilization			59.8%		ICU Level of Service				B			
Analysis Period (min)			15									

HCM Unsignalized Intersection Capacity Analysis
9: Site Access & MD 198

Cheng Property
PM Background

	→	↘	↙	←	↖	↗	
Movement	EBT	EBR	WBL	WBT	NBL	NBR	
Lane Configurations	↑↑↑			↑↑↑			↗
Traffic Volume (veh/h)	1169	2	0	1406	0	86	
Future Volume (Veh/h)	1169	2	0	1406	0	86	
Sign Control	Free			Free	Stop		
Grade	0%			0%	0%		
Peak Hour Factor	0.92	0.92	0.92	0.92	0.92	0.92	
Hourly flow rate (vph)	1271	2	0	1528	0	93	
Pedestrians							
Lane Width (ft)							
Walking Speed (ft/s)							
Percent Blockage							
Right turn flare (veh)							
Median type	None			None			
Median storage (veh)							
Upstream signal (ft)	279						
pX, platoon unblocked					0.82		
vC, conflicting volume				1273	1781	425	
vC1, stage 1 conf vol							
vC2, stage 2 conf vol							
vCu, unblocked vol				1273	1180	425	
tC, single (s)				4.1	6.8	6.9	
tC, 2 stage (s)							
tF (s)				2.2	3.5	3.3	
p0 queue free %				100	100	84	
cM capacity (veh/h)				541	150	578	
Direction, Lane #	EB 1	EB 2	EB 3	WB 1	WB 2	WB 3	NB 1
Volume Total	508	508	256	509	509	509	93
Volume Left	0	0	0	0	0	0	0
Volume Right	0	0	2	0	0	0	93
cSH	1700	1700	1700	1700	1700	1700	578
Volume to Capacity	0.30	0.30	0.15	0.30	0.30	0.30	0.16
Queue Length 95th (ft)	0	0	0	0	0	0	14
Control Delay (s)	0.0	0.0	0.0	0.0	0.0	0.0	12.4
Lane LOS							
Approach Delay (s)	0.0			0.0			12.4
Approach LOS							
Intersection Summary							
Average Delay				0.4			
Intersection Capacity Utilization				34.6%	ICU Level of Service		A
Analysis Period (min)	15						

HCM Signalized Intersection Capacity Analysis
 1: US 29 NB Off Ramp/US 29 NB On Ramp & MD 198

Cheng Property
 PM Total



























Movement	EBL	EBT	EBR	WBL	WBT	WBR	NBL	NBT	NBR	SBL	SBT	SBR	
Lane Configurations													
Traffic Volume (vph)	269	1178	0	0	1282	516	229	5	436	0	0	0	
Future Volume (vph)	269	1178	0	0	1282	516	229	5	436	0	0	0	
Ideal Flow (vphpl)	1900	1900	1900	1900	1900	1900	1900	1900	1900	1900	1900	1900	
Total Lost time (s)	4.5	4.5			4.5	4.5	4.5	4.5	4.5				
Lane Util. Factor	0.97	0.91			0.91	1.00	0.95	0.95	1.00				
Frt	1.00	1.00			1.00	0.85	1.00	1.00	0.85				
Flt Protected	0.95	1.00			1.00	1.00	0.95	0.95	1.00				
Satd. Flow (prot)	3433	5085			5085	1583	1681	1689	1583				
Flt Permitted	0.95	1.00			1.00	1.00	0.95	0.95	1.00				
Satd. Flow (perm)	3433	5085			5085	1583	1681	1689	1583				
Peak-hour factor, PHF	0.92	0.92	0.92	0.92	0.92	0.92	0.92	0.92	0.92	0.92	0.92	0.92	
Adj. Flow (vph)	292	1280	0	0	1393	561	249	5	474	0	0	0	
RTOR Reduction (vph)	0	0	0	0	0	255	0	0	80	0	0	0	
Lane Group Flow (vph)	292	1280	0	0	1393	306	127	127	394	0	0	0	
Turn Type	Prot	NA			NA	Perm	Perm	NA	Perm				
Protected Phases	7	4			8			2					
Permitted Phases						8	2		2				
Actuated Green, G (s)	15.5	85.5			65.5	65.5	25.5	25.5	25.5				
Effective Green, g (s)	15.5	85.5			65.5	65.5	25.5	25.5	25.5				
Actuated g/C Ratio	0.13	0.71			0.55	0.55	0.21	0.21	0.21				
Clearance Time (s)	4.5	4.5			4.5	4.5	4.5	4.5	4.5				
Vehicle Extension (s)	3.0	3.0			3.0	3.0	3.0	3.0	3.0				
Lane Grp Cap (vph)	443	3623			2775	864	357	358	336				
v/s Ratio Prot	c0.09	0.25			c0.27								
v/s Ratio Perm						0.19	0.08	0.08	c0.25				
v/c Ratio	0.66	0.35			0.50	0.35	0.36	0.35	1.17				
Uniform Delay, d1	49.7	6.6			17.0	15.3	40.3	40.2	47.2				
Progression Factor	1.06	0.56			1.00	1.00	1.00	1.00	1.00				
Incremental Delay, d2	3.3	0.3			0.7	1.1	2.8	2.7	105.2				
Delay (s)	56.2	4.0			17.7	16.5	43.0	43.0	152.5				
Level of Service	E	A			B	B	D	D	F				
Approach Delay (s)		13.7			17.3			114.3			0.0		
Approach LOS		B			B			F			A		
Intersection Summary													
HCM 2000 Control Delay			32.6		HCM 2000 Level of Service				C				
HCM 2000 Volume to Capacity ratio			0.69										
Actuated Cycle Length (s)			120.0		Sum of lost time (s)				13.5				
Intersection Capacity Utilization			57.3%		ICU Level of Service				B				
Analysis Period (min)			15										

c Critical Lane Group

HCM Signalized Intersection Capacity Analysis

2: Old Columbia Pike & MD 198























Cheng Property
PM Total

												
Movement	EBL	EBT	EBR	WBL	WBT	WBR	NBL	NBT	NBR	SBL	SBT	SBR
Lane Configurations		  		 	 					 	  	
Traffic Volume (vph)	312	783	94	323	799	298	0	0	0	552	261	666
Future Volume (vph)	312	783	94	323	799	298	0	0	0	552	261	666
Ideal Flow (vphpl)	1900	1900	1900	1900	1900	1900	1900	1900	1900	1900	1900	1900
Total Lost time (s)	4.5	4.5		4.5	4.5	4.5				4.5	4.5	4.5
Lane Util. Factor	1.00	0.91		0.97	0.95	1.00				0.86	0.86	1.00
Frt	1.00	0.98		1.00	1.00	0.85				1.00	1.00	0.85
Flt Protected	0.95	1.00		0.95	1.00	1.00				0.95	0.98	1.00
Satd. Flow (prot)	1770	5004		3433	3539	1583				3044	3147	1583
Flt Permitted	0.95	1.00		0.95	1.00	1.00				0.95	0.98	1.00
Satd. Flow (perm)	1770	5004		3433	3539	1583				3044	3147	1583
Peak-hour factor, PHF	0.92	0.92	0.92	0.92	0.92	0.92	0.92	0.92	0.92	0.92	0.92	0.92
Adj. Flow (vph)	339	851	102	351	868	324	0	0	0	600	284	724
RTOR Reduction (vph)	0	13	0	0	0	215	0	0	0	0	0	233
Lane Group Flow (vph)	339	940	0	351	868	109	0	0	0	438	446	491
Turn Type	Prot	NA		Prot	NA	Perm				Perm	NA	Perm
Protected Phases	7	4		3	8						6	
Permitted Phases						8				6		6
Actuated Green, G (s)	20.5	43.2		17.5	40.2	40.2				45.8	45.8	45.8
Effective Green, g (s)	20.5	43.2		17.5	40.2	40.2				45.8	45.8	45.8
Actuated g/C Ratio	0.17	0.36		0.15	0.34	0.34				0.38	0.38	0.38
Clearance Time (s)	4.5	4.5		4.5	4.5	4.5				4.5	4.5	4.5
Vehicle Extension (s)	3.0	3.0		3.0	3.0	3.0				3.0	3.0	3.0
Lane Grp Cap (vph)	302	1801		500	1185	530				1161	1201	604
v/s Ratio Prot	c0.19	c0.19		0.10	c0.25							
v/s Ratio Perm						0.07				0.14	0.14	c0.31
v/c Ratio	1.12	0.52		0.70	0.73	0.20				0.38	0.37	0.81
Uniform Delay, d1	49.8	30.3		48.8	35.2	28.5				26.8	26.7	33.3
Progression Factor	1.32	0.90		0.78	1.03	5.99				1.00	1.00	1.00
Incremental Delay, d2	83.4	0.2		4.0	2.1	0.2				0.9	0.9	11.4
Delay (s)	149.3	27.5		41.8	38.3	170.8				27.7	27.6	44.6
Level of Service	F	C		D	D	F				C	C	D
Approach Delay (s)		59.4			66.9			0.0			35.3	
Approach LOS		E			E			A			D	
Intersection Summary												
HCM 2000 Control Delay			53.3				HCM 2000 Level of Service			D		
HCM 2000 Volume to Capacity ratio			0.83									
Actuated Cycle Length (s)			120.0				Sum of lost time (s)			13.5		
Intersection Capacity Utilization			70.8%				ICU Level of Service			C		
Analysis Period (min)			15									

c Critical Lane Group

HCM Signalized Intersection Capacity Analysis
3: Old Columbia Pike & National Drive

Cheng Property
PM Total

























												
Movement	EBL	EBT	EBR	WBL	WBT	WBR	NBL	NBT	NBR	SBL	SBT	SBR
Lane Configurations												
Traffic Volume (vph)	74	2	298	351	21	34	186	236	216	9	832	127
Future Volume (vph)	74	2	298	351	21	34	186	236	216	9	832	127
Ideal Flow (vphpl)	1900	1900	1900	1900	1900	1900	1900	1900	1900	1900	1900	1900
Total Lost time (s)		4.5	4.5	4.5	4.5		4.5	4.5	4.5	4.5	4.5	4.5
Lane Util. Factor		1.00	1.00	1.00	1.00		1.00	0.91	1.00	1.00	0.91	1.00
Frt		1.00	0.85	1.00	0.91		1.00	1.00	0.85	1.00	1.00	0.85
Flt Protected		0.95	1.00	0.95	1.00		0.95	1.00	1.00	0.95	1.00	1.00
Satd. Flow (prot)		1776	1583	1770	1690		1770	5085	1583	1770	5085	1583
Flt Permitted		0.72	1.00	0.70	1.00		0.28	1.00	1.00	0.59	1.00	1.00
Satd. Flow (perm)		1344	1583	1311	1690		526	5085	1583	1092	5085	1583
Peak-hour factor, PHF	0.92	0.92	0.92	0.92	0.92	0.92	0.92	0.92	0.92	0.92	0.92	0.92
Adj. Flow (vph)	80	2	324	382	23	37	202	257	235	10	904	138
RTOR Reduction (vph)	0	0	92	0	26	0	0	0	99	0	0	58
Lane Group Flow (vph)	0	82	232	382	34	0	202	257	136	10	904	80
Turn Type	Perm	NA	Perm	Perm	NA		Perm	NA	Perm	Perm	NA	Perm
Protected Phases		4			8			2			6	
Permitted Phases	4		4	8			2		2	6		6
Actuated Green, G (s)		24.8	24.8	24.8	24.8		46.2	46.2	46.2	46.2	46.2	46.2
Effective Green, g (s)		24.8	24.8	24.8	24.8		46.2	46.2	46.2	46.2	46.2	46.2
Actuated g/C Ratio		0.31	0.31	0.31	0.31		0.58	0.58	0.58	0.58	0.58	0.58
Clearance Time (s)		4.5	4.5	4.5	4.5		4.5	4.5	4.5	4.5	4.5	4.5
Vehicle Extension (s)		3.0	3.0	3.0	3.0		3.0	3.0	3.0	3.0	3.0	3.0
Lane Grp Cap (vph)		416	490	406	523		303	2936	914	630	2936	914
v/s Ratio Prot					0.02			0.05			0.18	
v/s Ratio Perm		0.06	0.15	c0.29			c0.38		0.09	0.01		0.05
v/c Ratio		0.20	0.47	0.94	0.07		0.67	0.09	0.15	0.02	0.31	0.09
Uniform Delay, d1		20.3	22.3	26.9	19.4		11.6	7.5	7.8	7.2	8.7	7.5
Progression Factor		1.00	1.00	1.00	1.00		1.00	1.00	1.00	1.00	1.00	1.00
Incremental Delay, d2		0.2	0.7	30.0	0.1		11.1	0.1	0.3	0.0	0.3	0.2
Delay (s)		20.5	23.0	56.9	19.5		22.7	7.6	8.2	7.3	9.0	7.7
Level of Service		C	C	E	B		C	A	A	A	A	A
Approach Delay (s)		22.5			51.8			12.2			8.8	
Approach LOS		C			D			B			A	
Intersection Summary												
HCM 2000 Control Delay			19.2				HCM 2000 Level of Service				B	
HCM 2000 Volume to Capacity ratio			0.76									
Actuated Cycle Length (s)			80.0				Sum of lost time (s)				9.0	
Intersection Capacity Utilization			65.2%				ICU Level of Service				C	
Analysis Period (min)			15									

c Critical Lane Group

HCM Signalized Intersection Capacity Analysis

4: Old Columbia Pike & MD 198

Cheng Property
PM Total

												
Movement	EBL	EBT	EBR	WBL	WBT	WBR	NBL	NBT	NBR	SBL	SBT	SBR
Lane Configurations		 			 							
Traffic Volume (vph)	14	894	80	465	1002	24	83	12	335	36	29	7
Future Volume (vph)	14	894	80	465	1002	24	83	12	335	36	29	7
Ideal Flow (vphpl)	1900	1900	1900	1900	1900	1900	1900	1900	1900	1900	1900	1900
Total Lost time (s)	4.5	4.5		4.5	4.5		4.5	4.5	4.5	4.5	4.5	
Lane Util. Factor	1.00	0.95		1.00	0.95		1.00	1.00	1.00	1.00	1.00	
Frt	1.00	0.99		1.00	1.00		1.00	1.00	0.85	1.00	0.97	
Flt Protected	0.95	1.00		0.95	1.00		0.95	1.00	1.00	0.95	1.00	
Satd. Flow (prot)	1770	3496		1770	3527		1770	1863	1583	1770	1807	
Flt Permitted	0.26	1.00		0.14	1.00		0.73	1.00	1.00	0.75	1.00	
Satd. Flow (perm)	476	3496		261	3527		1362	1863	1583	1395	1807	
Peak-hour factor, PHF	0.92	0.92	0.92	0.92	0.92	0.92	0.92	0.92	0.92	0.92	0.92	0.92
Adj. Flow (vph)	15	972	87	505	1089	26	90	13	364	39	32	8
RTOR Reduction (vph)	0	5	0	0	1	0	0	0	273	0	6	0
Lane Group Flow (vph)	15	1054	0	505	1114	0	90	13	91	39	34	0
Turn Type	pm+pt	NA		pm+pt	NA		Perm	NA	Perm	Perm	NA	
Protected Phases	7	4		3	8			2			6	
Permitted Phases	4			8			2		2	6		
Actuated Green, G (s)	58.0	55.5		85.5	78.5		25.5	25.5	25.5	25.5	25.5	
Effective Green, g (s)	58.0	55.5		85.5	78.5		25.5	25.5	25.5	25.5	25.5	
Actuated g/C Ratio	0.48	0.46		0.71	0.65		0.21	0.21	0.21	0.21	0.21	
Clearance Time (s)	4.5	4.5		4.5	4.5		4.5	4.5	4.5	4.5	4.5	
Vehicle Extension (s)	3.0	3.0		3.0	3.0		3.0	3.0	3.0	3.0	3.0	
Lane Grp Cap (vph)	257	1616		506	2307		289	395	336	296	383	
v/s Ratio Prot	0.00	0.30		c0.21	0.32			0.01			0.02	
v/s Ratio Perm	0.03			c0.50			c0.07		0.06	0.03		
v/c Ratio	0.06	0.65		1.00	0.48		0.31	0.03	0.27	0.13	0.09	
Uniform Delay, d1	16.2	24.8		31.0	10.5		39.8	37.5	39.5	38.3	37.9	
Progression Factor	1.00	1.00		1.19	0.25		1.00	1.00	1.00	1.00	1.00	
Incremental Delay, d2	0.1	2.1		32.6	0.5		2.8	0.2	2.0	0.9	0.5	
Delay (s)	16.2	26.9		69.5	3.1		42.6	37.6	41.4	39.2	38.4	
Level of Service	B	C		E	A		D	D	D	D	D	
Approach Delay (s)		26.7			23.8			41.6			38.8	
Approach LOS		C			C			D			D	
Intersection Summary												
HCM 2000 Control Delay			27.7				HCM 2000 Level of Service			C		
HCM 2000 Volume to Capacity ratio			0.86									
Actuated Cycle Length (s)			120.0				Sum of lost time (s)			13.5		
Intersection Capacity Utilization			75.5%				ICU Level of Service			D		
Analysis Period (min)			15									

c Critical Lane Group

HCM Unsignalized Intersection Capacity Analysis

5: Blackburn Road & US 29 SB Off Ramp



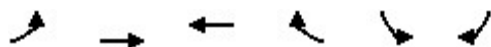

















Cheng Property
PM Total



Movement	EBL	EBT	WBT	WBR	SBL	SBR
Lane Configurations		↑	↑		↘	
Traffic Volume (veh/h)	0	33	165	0	117	73
Future Volume (Veh/h)	0	33	165	0	117	73
Sign Control		Free	Free		Stop	
Grade		0%	0%		0%	
Peak Hour Factor	0.92	0.92	0.92	0.92	0.92	0.92
Hourly flow rate (vph)	0	36	179	0	127	79
Pedestrians						
Lane Width (ft)						
Walking Speed (ft/s)						
Percent Blockage						
Right turn flare (veh)						
Median type		None	None			
Median storage (veh)						
Upstream signal (ft)						
pX, platoon unblocked						
vC, conflicting volume	179				215	179
vC1, stage 1 conf vol						
vC2, stage 2 conf vol						
vCu, unblocked vol	179				215	179
tC, single (s)	4.1				6.4	6.2
tC, 2 stage (s)						
tF (s)	2.2				3.5	3.3
p0 queue free %	100				84	91
cM capacity (veh/h)	1397				773	864
Direction, Lane #	EB 1	WB 1	SB 1			
Volume Total	36	179	206			
Volume Left	0	0	127			
Volume Right	0	0	79			
cSH	1700	1700	806			
Volume to Capacity	0.02	0.11	0.26			
Queue Length 95th (ft)	0	0	25			
Control Delay (s)	0.0	0.0	11.0			
Lane LOS			B			
Approach Delay (s)	0.0	0.0	11.0			
Approach LOS			B			
Intersection Summary						
Average Delay			5.4			
Intersection Capacity Utilization			26.3%	ICU Level of Service	A	
Analysis Period (min)			15			

















HCM Unsignalized Intersection Capacity Analysis
6: Lions Den Drive/Burtonsville Drive & MD 198

Cheng Property
PM Total

												
Movement	EBL	EBT	EBR	WBL	WBT	WBR	NBL	NBT	NBR	SBL	SBT	SBR
Lane Configurations												
Traffic Volume (veh/h)	1	958	8	17	1059	6	4	0	15	2	0	0
Future Volume (Veh/h)	1	958	8	17	1059	6	4	0	15	2	0	0
Sign Control		Free			Free			Stop			Stop	
Grade		0%			0%			0%			0%	
Peak Hour Factor	0.92	0.92	0.92	0.92	0.92	0.92	0.92	0.92	0.92	0.92	0.92	0.92
Hourly flow rate (vph)	1	1041	9	18	1151	7	4	0	16	2	0	0
Pedestrians												
Lane Width (ft)												
Walking Speed (ft/s)												
Percent Blockage												
Right turn flare (veh)												
Median type												
		None			None							
Median storage (veh)												
Upstream signal (ft)												
pX, platoon unblocked												
vC, conflicting volume	1158			1050			2230	2237	1041	2250	2242	1154
vC1, stage 1 conf vol												
vC2, stage 2 conf vol												
vCu, unblocked vol	1158			1050			2230	2237	1041	2250	2242	1154
tC, single (s)	4.1			4.1			7.1	6.5	6.2	7.1	6.5	6.2
tC, 2 stage (s)												
tF (s)	2.2			2.2			3.5	4.0	3.3	3.5	4.0	3.3
p0 queue free %	100			97			87	100	94	93	100	100
cM capacity (veh/h)	603			663			30	41	279	27	41	240
Direction, Lane #	EB 1	EB 2	EB 3	WB 1	WB 2	NB 1	SB 1					
Volume Total	1	1041	9	18	1158	20	2					
Volume Left	1	0	0	18	0	4	2					
Volume Right	0	0	9	0	7	16	0					
cSH	603	1700	1700	663	1700	105	27					
Volume to Capacity	0.00	0.61	0.01	0.03	0.68	0.19	0.07					
Queue Length 95th (ft)	0	0	0	2	0	17	6					
Control Delay (s)	11.0	0.0	0.0	10.6	0.0	47.4	147.2					
Lane LOS	B			B		E	F					
Approach Delay (s)	0.0			0.2		47.4	147.2					
Approach LOS						E	F					
Intersection Summary												
Average Delay			0.6									
Intersection Capacity Utilization			66.1%		ICU Level of Service		C					
Analysis Period (min)			15									

HCM Signalized Intersection Capacity Analysis
7: Old Columbia Pike & Greencastle Road





















Cheng Property
PM Total

													
Movement	EBL	EBT	EBR	WBL	WBT	WBR	NBL	NBT	NBR	SBL	SBT	SBR	
Lane Configurations													
Traffic Volume (vph)	15	10	3	55	11	109	6	291	71	162	536	25	
Future Volume (vph)	15	10	3	55	11	109	6	291	71	162	536	25	
Ideal Flow (vphpl)	1900	1900	1900	1900	1900	1900	1900	1900	1900	1900	1900	1900	
Total Lost time (s)		4.5			4.5			4.5	4.5		4.5		
Lane Util. Factor		1.00			1.00			1.00	1.00		1.00		
Frt		0.99			0.92			1.00	0.85		1.00		
Flt Protected		0.97			0.98			1.00	1.00		0.99		
Satd. Flow (prot)		1790			1680			1861	1583		1834		
Flt Permitted		0.79			0.88			0.99	1.00		0.84		
Satd. Flow (perm)		1459			1507			1837	1583		1564		
Peak-hour factor, PHF	0.92	0.92	0.92	0.92	0.92	0.92	0.92	0.92	0.92	0.92	0.92	0.92	
Adj. Flow (vph)	16	11	3	60	12	118	7	316	77	176	583	27	
RTOR Reduction (vph)	0	3	0	0	100	0	0	0	27	0	1	0	
Lane Group Flow (vph)	0	27	0	0	90	0	0	323	50	0	785	0	
Turn Type	Perm	NA		Perm	NA		Perm	NA	Perm	Perm	NA		
Protected Phases		2			6			4			8		
Permitted Phases	2			6			4		4	8			
Actuated Green, G (s)		6.8			6.8			29.2	29.2		29.2		
Effective Green, g (s)		6.8			6.8			29.2	29.2		29.2		
Actuated g/C Ratio		0.15			0.15			0.65	0.65		0.65		
Clearance Time (s)		4.5			4.5			4.5	4.5		4.5		
Vehicle Extension (s)		3.0			3.0			3.0	3.0		3.0		
Lane Grp Cap (vph)		220			227			1192	1027		1014		
v/s Ratio Prot													
v/s Ratio Perm		0.02			c0.06			0.18	0.03		c0.50		
v/c Ratio		0.12			0.40			0.27	0.05		0.77		
Uniform Delay, d1		16.5			17.2			3.4	2.9		5.6		
Progression Factor		1.00			1.00			1.00	1.00		1.00		
Incremental Delay, d2		0.3			1.1			0.6	0.1		5.7		
Delay (s)		16.8			18.4			3.9	3.0		11.3		
Level of Service		B			B			A	A		B		
Approach Delay (s)		16.8			18.4			3.7			11.3		
Approach LOS		B			B			A			B		
Intersection Summary													
HCM 2000 Control Delay			10.2									HCM 2000 Level of Service	B
HCM 2000 Volume to Capacity ratio			0.70										
Actuated Cycle Length (s)			45.0									Sum of lost time (s)	9.0
Intersection Capacity Utilization			76.7%									ICU Level of Service	D
Analysis Period (min)			15										

c Critical Lane Group

HCM Signalized Intersection Capacity Analysis
8: Site Access/Shopping Center & MD 198









Cheng Property
PM Total

												
Movement	EBL	EBT	EBR	WBL	WBT	WBR	NBL	NBT	NBR	SBL	SBT	SBR
Lane Configurations												
Traffic Volume (vph)	164	1086	80	96	1190	127	48	2	24	25	10	180
Future Volume (vph)	164	1086	80	96	1190	127	48	2	24	25	10	180
Ideal Flow (vphpl)	1900	1900	1900	1900	1900	1900	1900	1900	1900	1900	1900	1900
Total Lost time (s)	4.5	4.5		4.5	4.5	4.5		4.5	4.5		4.5	4.5
Lane Util. Factor	1.00	0.95		1.00	0.95	1.00		1.00	1.00		1.00	1.00
Frt	1.00	0.99		1.00	1.00	0.85		1.00	0.85		1.00	0.85
Flt Protected	0.95	1.00		0.95	1.00	1.00		0.95	1.00		0.97	1.00
Satd. Flow (prot)	1770	3503		1770	3539	1583		1777	1583		1799	1583
Flt Permitted	0.07	1.00		0.11	1.00	1.00		0.95	1.00		0.97	1.00
Satd. Flow (perm)	131	3503		203	3539	1583		1777	1583		1799	1583
Peak-hour factor, PHF	0.92	0.92	0.92	0.92	0.92	0.92	0.92	0.92	0.92	0.92	0.92	0.92
Adj. Flow (vph)	178	1180	87	104	1293	138	52	2	26	27	11	196
RTOR Reduction (vph)	0	5	0	0	0	74	0	0	22	0	0	167
Lane Group Flow (vph)	178	1262	0	104	1293	64	0	54	4	0	38	29
Turn Type	pm+pt	NA		pm+pt	NA	Perm	Split	NA	Perm	Split	NA	Perm
Protected Phases	7	4		3	8		2	2		6	6	
Permitted Phases	4			8		8			2			6
Actuated Green, G (s)	70.1	58.7		61.9	54.6	54.6		18.0	18.0		18.0	18.0
Effective Green, g (s)	70.1	58.7		61.9	54.6	54.6		18.0	18.0		18.0	18.0
Actuated g/C Ratio	0.58	0.49		0.52	0.46	0.46		0.15	0.15		0.15	0.15
Clearance Time (s)	4.5	4.5		4.5	4.5	4.5		4.5	4.5		4.5	4.5
Vehicle Extension (s)	3.0	3.0		3.0	3.0	3.0		3.0	3.0		3.0	3.0
Lane Grp Cap (vph)	232	1713		200	1610	720		266	237		269	237
v/s Ratio Prot	c0.07	0.36		0.03	c0.37			c0.03			c0.02	
v/s Ratio Perm	0.37			0.24		0.04			0.00			0.02
v/c Ratio	0.77	0.74		0.52	0.80	0.09		0.20	0.02		0.14	0.12
Uniform Delay, d1	29.6	24.5		19.2	28.1	18.6		44.7	43.5		44.3	44.2
Progression Factor	0.68	0.98		1.34	0.64	0.40		1.00	1.00		1.00	1.00
Incremental Delay, d2	11.6	2.3		1.8	3.2	0.2		1.7	0.1		1.1	1.1
Delay (s)	31.8	26.2		27.4	21.0	7.6		46.4	43.6		45.4	45.2
Level of Service	C	C		C	C	A		D	D		D	D
Approach Delay (s)		26.9			20.3			45.5			45.3	
Approach LOS		C			C			D			D	
Intersection Summary												
HCM 2000 Control Delay			25.6				HCM 2000 Level of Service			C		
HCM 2000 Volume to Capacity ratio			0.58									
Actuated Cycle Length (s)			120.0				Sum of lost time (s)		18.0			
Intersection Capacity Utilization			62.7%				ICU Level of Service			B		
Analysis Period (min)			15									

c Critical Lane Group

HCM Unsignalized Intersection Capacity Analysis
 9: Site Access & MD 198

Cheng Property
 PM Total

							
Movement	EBT	EBR	WBL	WBT	NBL	NBR	
Lane Configurations							
Traffic Volume (veh/h)	1169	12	0	1410	0	117	
Future Volume (Veh/h)	1169	12	0	1410	0	117	
Sign Control	Free			Free	Stop		
Grade	0%			0%	0%		
Peak Hour Factor	0.92	0.92	0.92	0.92	0.92	0.92	
Hourly flow rate (vph)	1271	13	0	1533	0	127	
Pedestrians							
Lane Width (ft)							
Walking Speed (ft/s)							
Percent Blockage							
Right turn flare (veh)							
Median type	None			None			
Median storage (veh)							
Upstream signal (ft)	249			279			
pX, platoon unblocked				0.75	0.85	0.75	
vC, conflicting volume				1284	1788	430	
vC1, stage 1 conf vol							
vC2, stage 2 conf vol							
vCu, unblocked vol				240	0	0	
tC, single (s)				4.1	6.8	6.9	
tC, 2 stage (s)							
tF (s)				2.2	3.5	3.3	
p0 queue free %				100	100	84	
cM capacity (veh/h)				1000	865	819	
Direction, Lane #	EB 1	EB 2	EB 3	WB 1	WB 2	WB 3	NB 1
Volume Total	508	508	267	511	511	511	127
Volume Left	0	0	0	0	0	0	0
Volume Right	0	0	13	0	0	0	127
cSH	1700	1700	1700	1700	1700	1700	819
Volume to Capacity	0.30	0.30	0.16	0.30	0.30	0.30	0.16
Queue Length 95th (ft)	0	0	0	0	0	0	14
Control Delay (s)	0.0	0.0	0.0	0.0	0.0	0.0	10.2
Lane LOS							
Approach Delay (s)	0.0				0.0		
Approach LOS							
Intersection Summary							
Average Delay				0.4			
Intersection Capacity Utilization				36.8%	ICU Level of Service	A	
Analysis Period (min)				15			

CRITICAL LANE VOLUME (CLV) METHODOLOGY for MSHA

Main Line: US 29 NB On Ramp
Minor Street: MD 198
Study Period: Existing Traffic

Analyst: Lenhart Traffic Consulting

Lane Use + Traffic Volumes

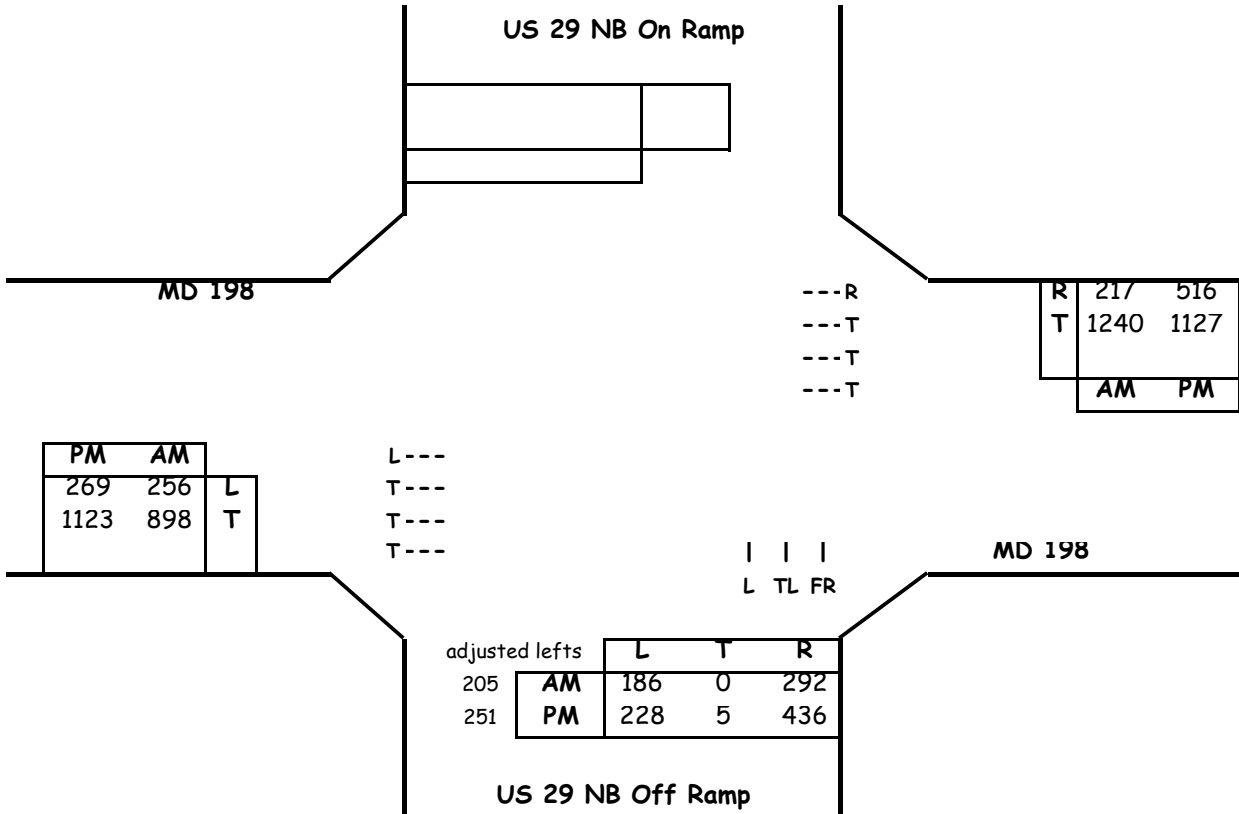

Critical Lane Volume Analysis

Morning Peak Hour							
Dir	Thru Volumes			+ Opposing Lefts			AM CLV
	VOL	x LUF	= Total	VOL	x LUF	= Total	
NB	205	1.00	205	0	0	0	205
SB	0	0.00	0	186	0.6	112	
EB	898	0.4	359	0	0	0	752
WB	1240	0.4	496	256	1	256	
CLV TOTAL=							957
Level of Service (LOS) =							A

Evening Peak Hour							
Dir	Thru Volumes			+ Opposing Lefts			PM CLV
	VOL	x LUF	= Total	VOL	x LUF	= Total	
NB	256	1.00	256	0	0	0	256
SB	0	0.00	0	228	0.6	137	
EB	1123	0.4	449	0	0	0	785
WB	516	1	516	269	1	269	
CLV TOTAL=							1041
Level of Service (LOS) =							B

Critical Lane Volume Analysis



LENHART TRAFFIC CONSULTING, INC.
 645 BALTIMORE ANNAPOLIS BLVD, SUITE 214
 SEVERNA PARK, MD 21146
 www.lenharttraffic.com

**US 29 NB On Ramp &
MD 198**
 (Existing Traffic)

Intersection
1

CRITICAL LANE VOLUME (CLV) METHODOLOGY for MSHA

Main Line: US 29 NB On Ramp
Minor Street: MD 198
Study Period: Background Traffic

Analyst: Lenhart Traffic Consulting

Lane Use + Traffic Volumes

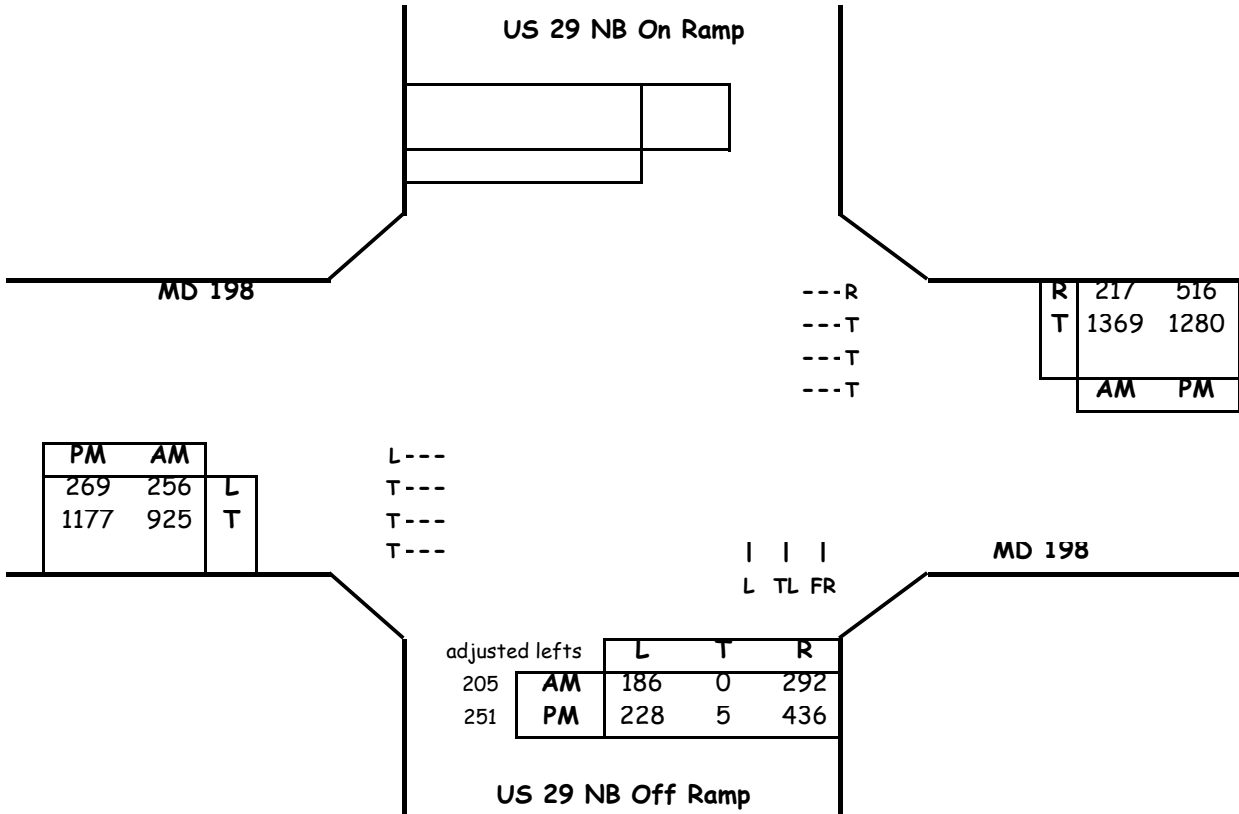

Critical Lane Volume Analysis

Morning Peak Hour							
Dir	Thru Volumes			+ Opposing Lefts			AM CLV
	VOL	x LUF	= Total	VOL	x LUF	= Total	
NB	205	1.00	205	0	0	0	205
SB	0	0.00	0	186	0.6	112	
EB	925	0.4	370	0	0	0	804
WB	1369	0.4	548	256	1	256	
CLV TOTAL=							1009
Level of Service (LOS) =							B

Evening Peak Hour							
Dir	Thru Volumes			+ Opposing Lefts			PM CLV
	VOL	x LUF	= Total	VOL	x LUF	= Total	
NB	256	1.00	256	0	0	0	256
SB	0	0.00	0	228	0.6	137	
EB	1177	0.4	471	0	0	0	785
WB	516	1	516	269	1	269	
CLV TOTAL=							1041
Level of Service (LOS) =							B

Critical Lane Volume Analysis



LENHART TRAFFIC CONSULTING, INC.
 645 BALTIMORE ANNAPOLIS BLVD, SUITE 214
 SEVERNA PARK, MD 21146
 www.lenharttraffic.com

**US 29 NB On Ramp &
MD 198**
 (Background Traffic)

Intersection
1

CRITICAL LANE VOLUME (CLV) METHODOLOGY for MSHA

Main Line: US 29 NB On Ramp
Minor Street: MD 198
Study Period: Total Traffic

Analyst: Lenhart Traffic Consulting

Lane Use + Traffic Volumes

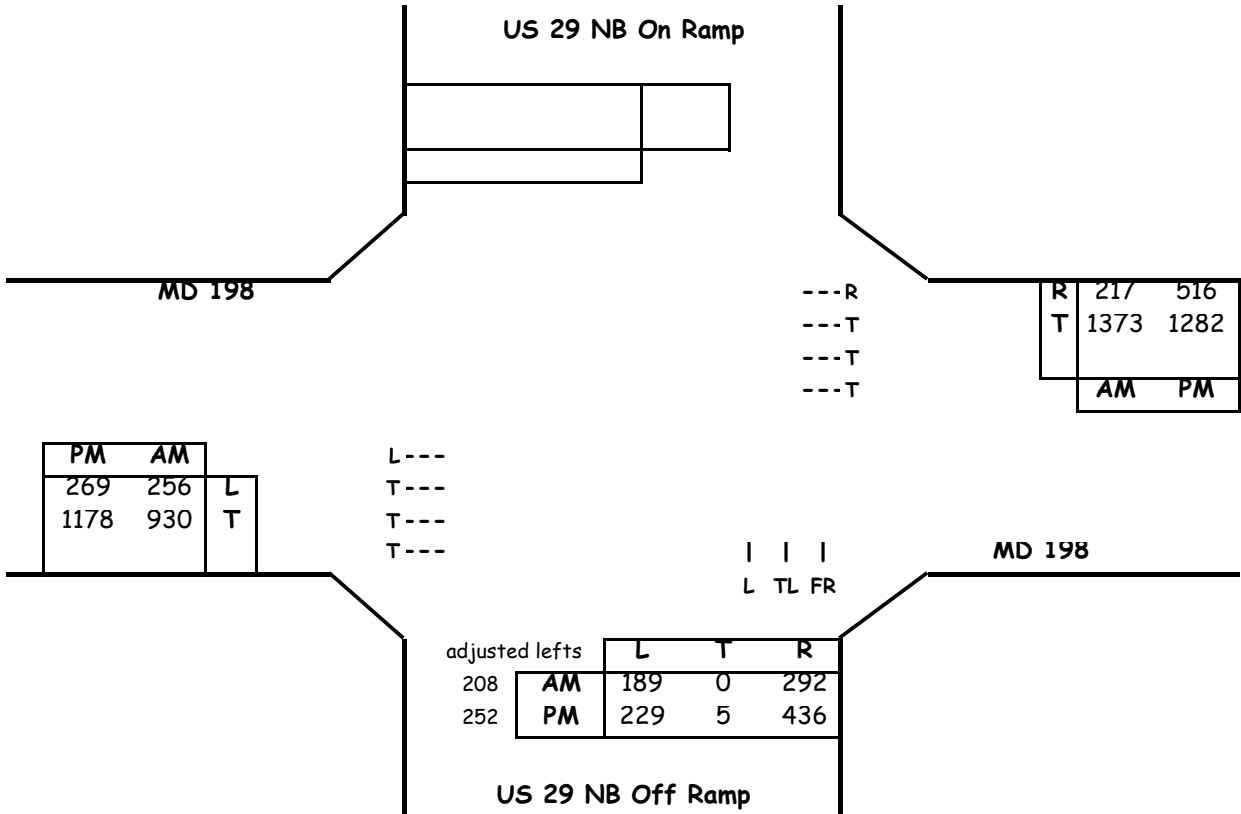

Critical Lane Volume Analysis

Morning Peak Hour							
Dir	Thru Volumes			+ Opposing Lefts			AM CLV
	VOL	x LUF	= Total	VOL	x LUF	= Total	
NB	208	1.00	208	0	0	0	208
SB	0	0.00	0	189	0.6	113	
EB	930	0.4	372	0	0	0	
WB	1373	0.4	549	256	1	256	
CLV TOTAL=							1013
Level of Service (LOS) =							B

Evening Peak Hour							
Dir	Thru Volumes			+ Opposing Lefts			PM CLV
	VOL	x LUF	= Total	VOL	x LUF	= Total	
NB	257	1.00	257	0	0	0	257
SB	0	0.00	0	229	0.6	137	
EB	1178	0.4	471	0	0	0	
WB	516	1	516	269	1	269	
CLV TOTAL=							1042
Level of Service (LOS) =							B

Critical Lane Volume Analysis



LENHART TRAFFIC CONSULTING, INC.
 645 BALTIMORE ANNAPOLIS BLVD, SUITE 214
 SEVERNA PARK, MD 21146
 www.lenharttraffic.com

**US 29 NB On Ramp &
MD 198**
(Total Traffic)

Intersection
1

CRITICAL LANE VOLUME (CLV) METHODOLOGY

Main Line: Old Columbia Pike
Minor Street: MD 198
Study Period: Existing Traffic

Analyst: Lenhart Traffic Consulting

Lane Use + Traffic Volumes

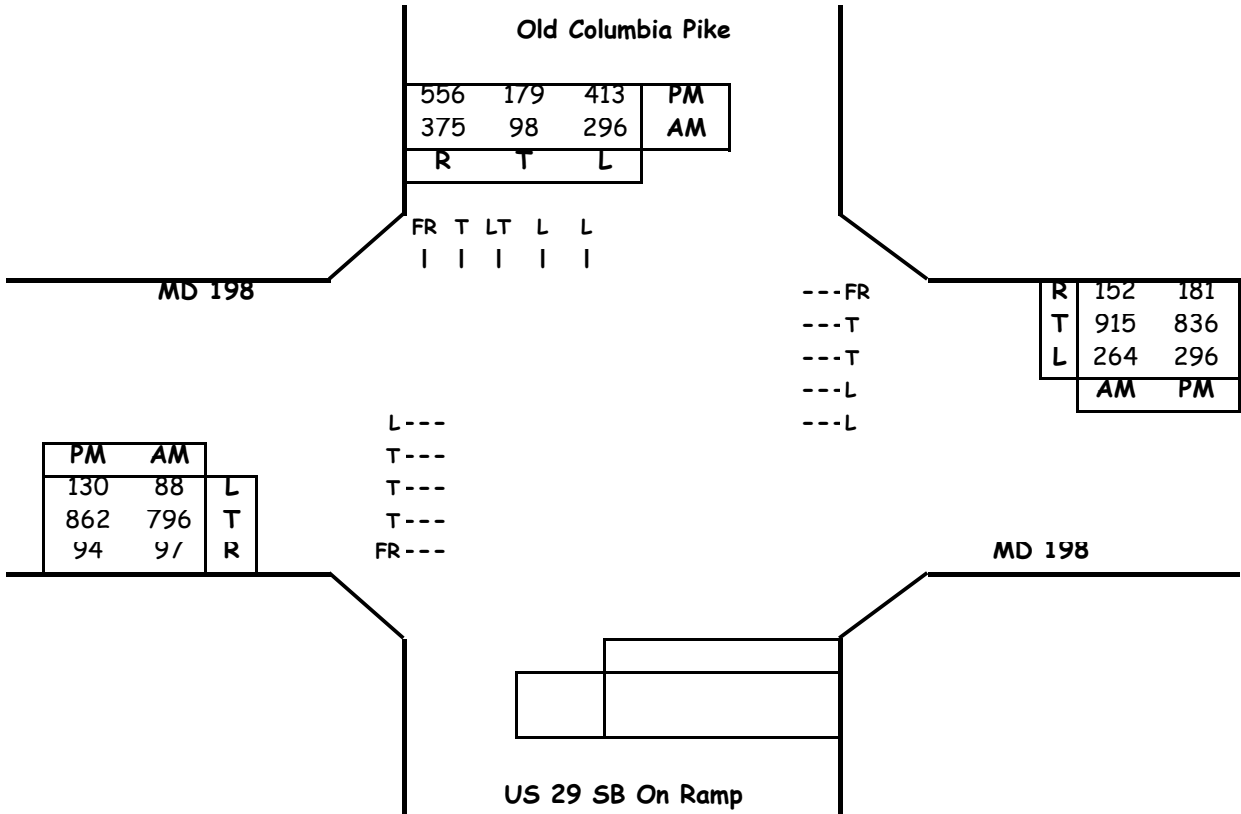

Critical Lane Volume Analysis

Morning Peak Hour							
Dir	Thru Volumes			+ Opposing Lefts			AM
	VOL	x LUF	= Total	VOL	x LUF	= Total	CLV
NB	0	0.00	0	296	0.4	118	217
SB	394	0.55	217	0	0	0	
EB	796	0.4	318	264	0.55	145	591
WB	915	0.55	503	88	1	88	
CLV TOTAL=							808
Level of Service (LOS)=							A

Evening Peak Hour							
Dir	Thru Volumes			+ Opposing Lefts			PM
	VOL	x LUF	= Total	VOL	x LUF	= Total	CLV
NB	0	0.00	0	413	0.4	165	326
SB	592	0.55	326	0	0	0	
EB	862	0.4	345	296	0.55	163	590
WB	836	0.55	460	130	1	130	
CLV TOTAL=							916
Level of Service (LOS)=							A

Critical Lane Volume Analysis



**Old Columbia Pike &
MD 198**
(Existing Traffic)

Intersection
2

CRITICAL LANE VOLUME (CLV) METHODOLOGY

Main Line: Old Columbia Pike
Minor Street: MD 198
Study Period: Background Traffic

Analyst: Lenhart Traffic Consulting

Lane Use + Traffic Volumes

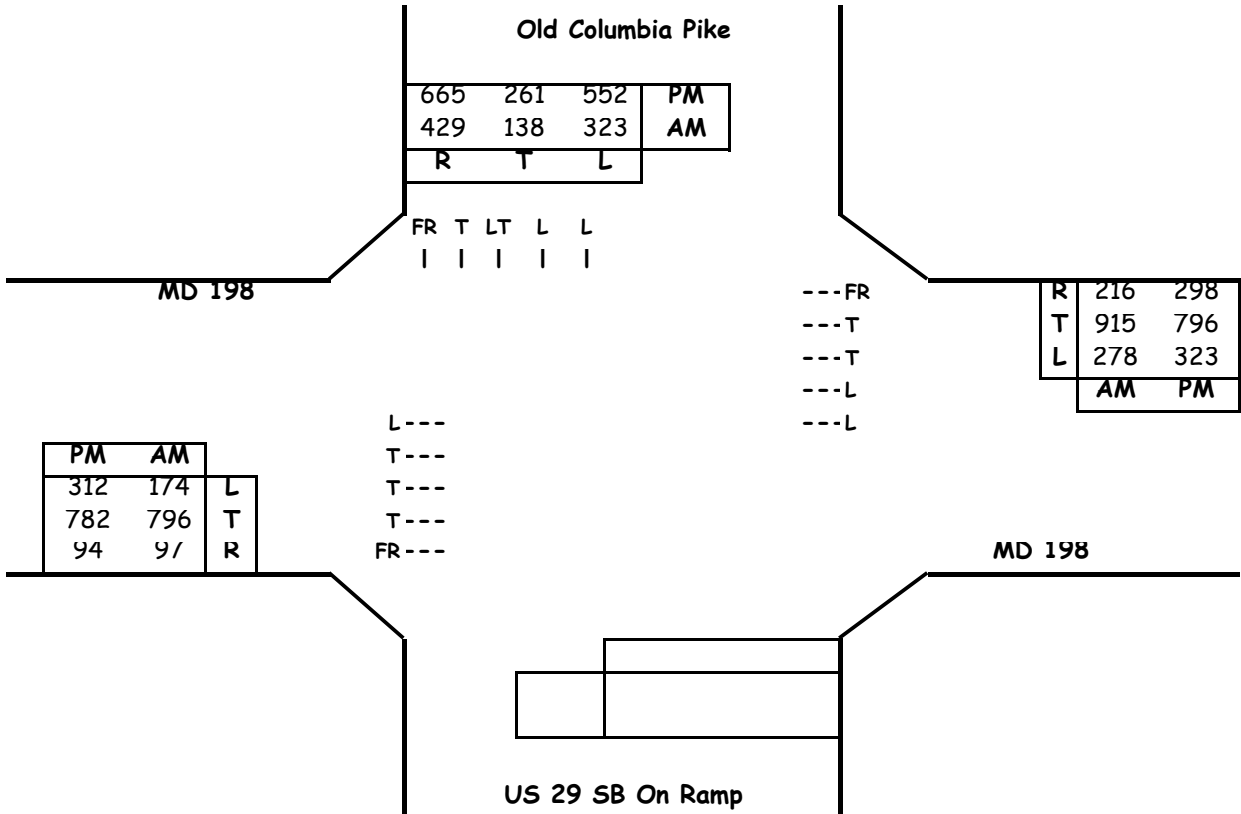

Critical Lane Volume Analysis

Morning Peak Hour							
Dir	Thru Volumes			+ Opposing Lefts			AM
	VOL	x LUF	= Total	VOL	x LUF	= Total	CLV
NB	0	0.00	0	323	0.4	129	254
SB	461	0.55	254	0	0	0	
EB	796	0.4	318	278	0.55	153	677
WB	915	0.55	503	174	1	174	
CLV TOTAL=							931
Level of Service (LOS)=							A

Evening Peak Hour							
Dir	Thru Volumes			+ Opposing Lefts			PM
	VOL	x LUF	= Total	VOL	x LUF	= Total	CLV
NB	0	0.00	0	552	0.4	221	447
SB	813	0.55	447	0	0	0	
EB	782	0.4	313	323	0.55	178	750
WB	796	0.55	438	312	1	312	
CLV TOTAL=							1197
Level of Service (LOS)=							C

Critical Lane Volume Analysis



LENHART TRAFFIC CONSULTING, INC.
 645 BALTIMORE ANNAPOLIS BLVD, SUITE 214
 SEVERNA PARK, MD 21146
 www.lenharttraffic.com

**Old Columbia Pike &
 MD 198**
 (Background Traffic)

Intersection
2

CRITICAL LANE VOLUME (CLV) METHODOLOGY

Main Line: Old Columbia Pike
Minor Street: MD 198
Study Period: Total Traffic

Analyst: Lenhart Traffic Consulting

Lane Use + Traffic Volumes

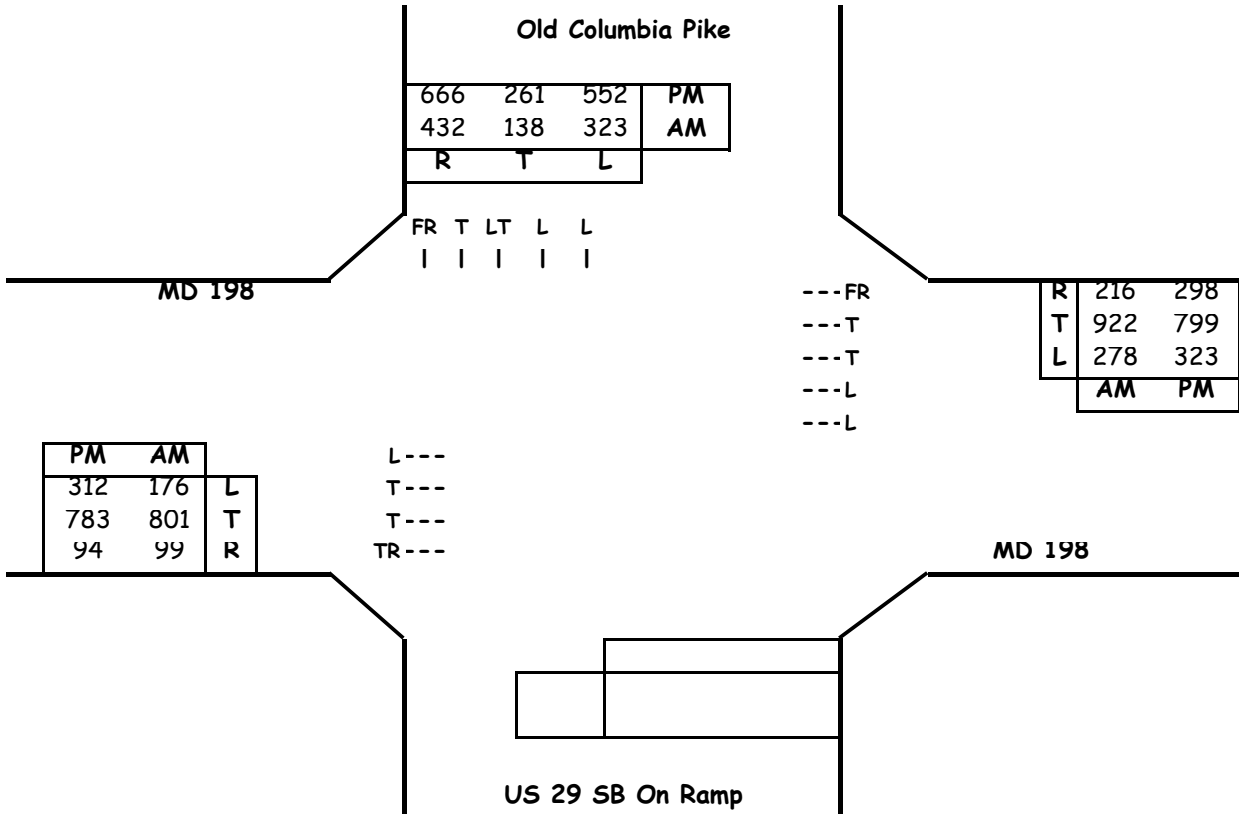

Critical Lane Volume Analysis

Morning Peak Hour							
Dir	Thru Volumes			+ Opposing Lefts			AM
	VOL	x LUF	= Total	VOL	x LUF	= Total	CLV
NB	0	0.00	0	323	0.4	129	254
SB	461	0.55	254	0	0	0	
EB	900	0.4	360	278	0.55	153	683
WB	922	0.55	507	176	1	176	
CLV TOTAL=							937
Level of Service (LOS)=							A

Evening Peak Hour							
Dir	Thru Volumes			+ Opposing Lefts			PM
	VOL	x LUF	= Total	VOL	x LUF	= Total	CLV
NB	0	0.00	0	552	0.4	221	447
SB	813	0.55	447	0	0	0	
EB	877	0.4	351	323	0.55	178	751
WB	799	0.55	439	312	1	312	
CLV TOTAL=							1198
Level of Service (LOS)=							C

Critical Lane Volume Analysis



**Old Columbia Pike &
MD 198**
(Total Traffic)

Intersection
2

CRITICAL LANE VOLUME (CLV) METHODOLOGY for MSHA

Main Line: Old Columbia Pike
Minor Street: National Drive
Study Period: Existing Traffic

Analyst: Lenhart Traffic Consulting

Lane Use + Traffic Volumes

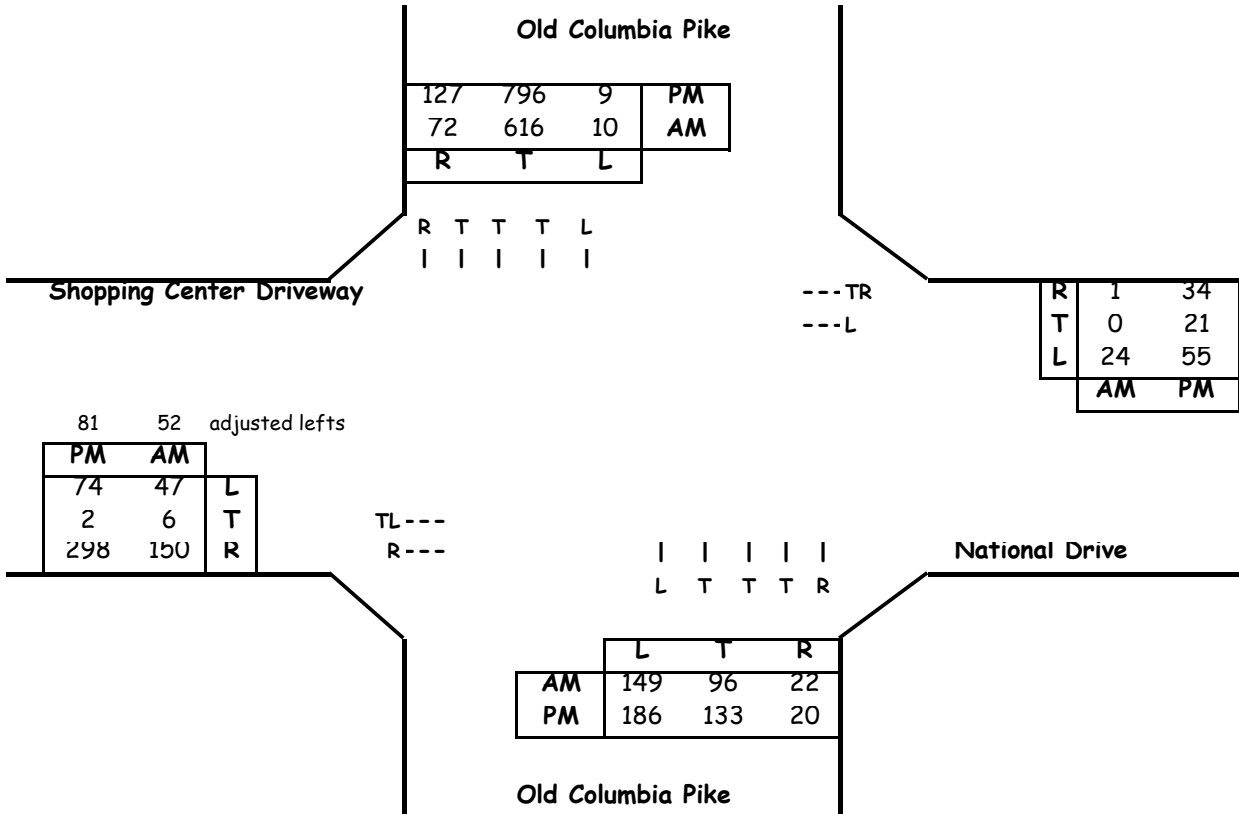

Critical Lane Volume Analysis

Morning Peak Hour							
Dir	Thru Volumes			+ Opposing Lefts			AM CLV
	VOL	x LUF	= Total	VOL	x LUF	= Total	
NB	96	0.40	38	10	1	10	395
SB	616	0.40	246	149	1	149	
EB	58	1	58	24	1	24	82
WB	1	1	1	47	1	47	
CLV TOTAL=							477
Level of Service (LOS)=							A

Evening Peak Hour							
Dir	Thru Volumes			+ Opposing Lefts			PM CLV
	VOL	x LUF	= Total	VOL	x LUF	= Total	
NB	133	0.40	53	9	1	9	504
SB	796	0.40	318	186	1	186	
EB	112	1	112	55	1	55	167
WB	55	1	55	74	1	74	
CLV TOTAL=							671
Level of Service (LOS)=							A

Critical Lane Volume Analysis



**Old Columbia Pike &
National Drive**
(Existing Traffic)

Intersection
3

CRITICAL LANE VOLUME (CLV) METHODOLOGY for MSHA

Main Line: Old Columbia Pike
Minor Street: National Drive
Study Period: Background Traffic

Analyst: Lenhart Traffic Consulting

Lane Use + Traffic Volumes

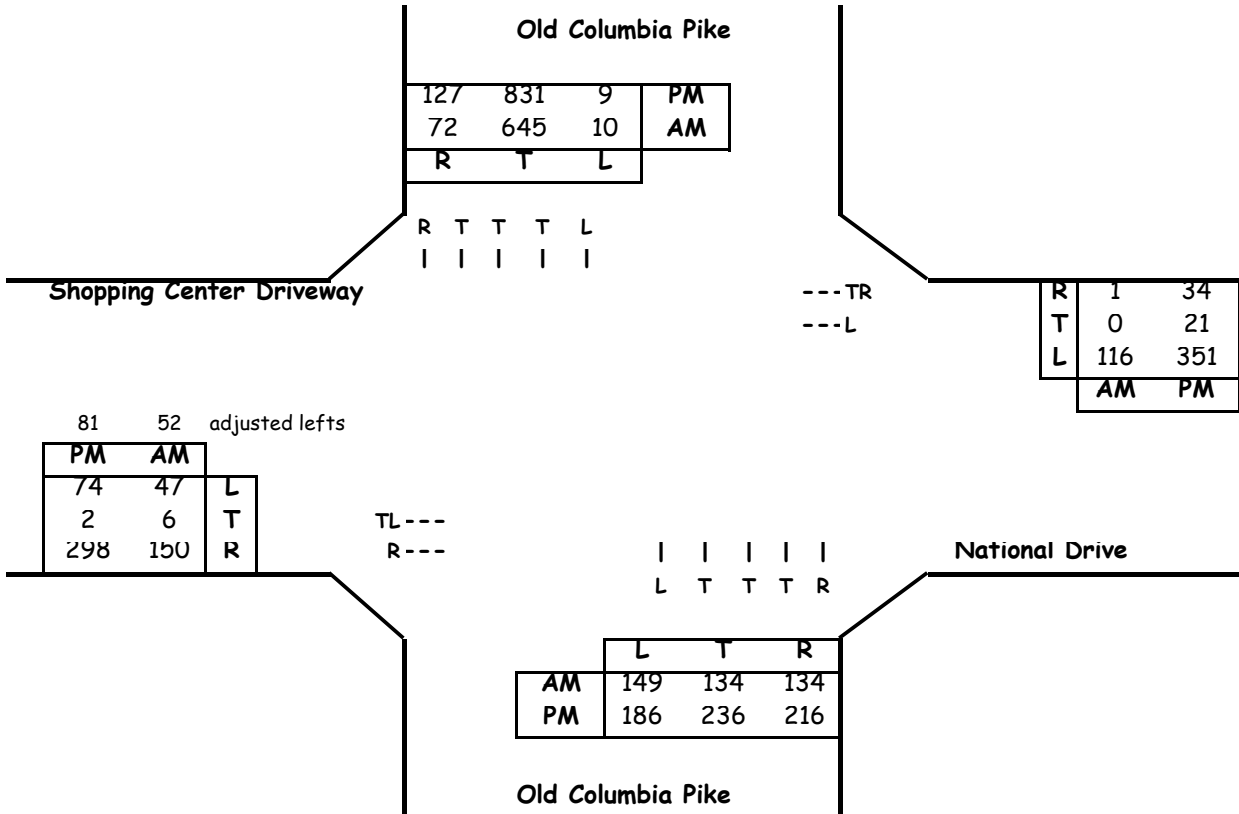

Critical Lane Volume Analysis

Morning Peak Hour							
Dir	Thru Volumes			+ Opposing Lefts			AM
	VOL	x LUF	= Total	VOL	x LUF	= Total	CLV
NB	134	0.40	54	10	1	10	407
SB	645	0.40	258	149	1	149	
EB	58	1	58	116	1	116	174
WB	1	1	1	47	1	47	
CLV TOTAL=							581
Level of Service (LOS)=							A

Evening Peak Hour							
Dir	Thru Volumes			+ Opposing Lefts			PM
	VOL	x LUF	= Total	VOL	x LUF	= Total	CLV
NB	236	0.40	94	9	1	9	518
SB	831	0.40	332	186	1	186	
EB	112	1	112	351	1	351	463
WB	55	1	55	74	1	74	
CLV TOTAL=							981
Level of Service (LOS)=							A

Critical Lane Volume Analysis



LENHART TRAFFIC CONSULTING, INC.
 645 BALTIMORE ANNAPOLIS BLVD, SUITE 214
 SEVERNA PARK, MD 21146
 www.lenharttraffic.com

**Old Columbia Pike &
National Drive**
(Background Traffic)

Intersection
3

CRITICAL LANE VOLUME (CLV) METHODOLOGY for MSHA

Main Line: Old Columbia Pike
Minor Street: National Drive
Study Period: Total Traffic

Analyst: Lenhart Traffic Consulting

Lane Use + Traffic Volumes

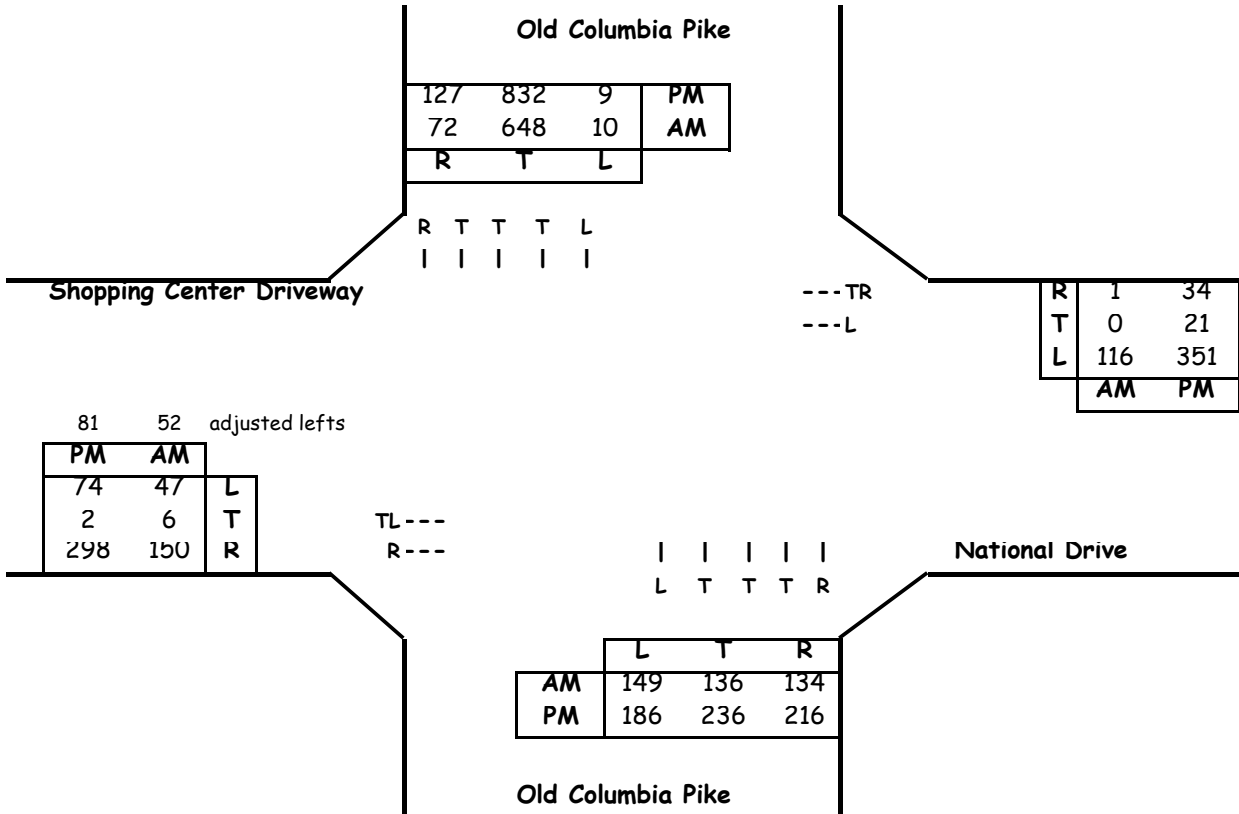

Critical Lane Volume Analysis

Morning Peak Hour							
Dir	Thru Volumes			+ Opposing Lefts			AM CLV
	VOL	x LUF	= Total	VOL	x LUF	= Total	
NB	136	0.40	54	10	1	10	408
SB	648	0.40	259	149	1	149	
EB	58	1	58	116	1	116	174
WB	1	1	1	47	1	47	
CLV TOTAL=							582
Level of Service (LOS)=							A

Evening Peak Hour							
Dir	Thru Volumes			+ Opposing Lefts			PM CLV
	VOL	x LUF	= Total	VOL	x LUF	= Total	
NB	236	0.40	94	9	1	9	519
SB	832	0.40	333	186	1	186	
EB	112	1	112	351	1	351	463
WB	55	1	55	74	1	74	
CLV TOTAL=							982
Level of Service (LOS)=							A

Critical Lane Volume Analysis



LENHART TRAFFIC CONSULTING, INC.
 645 BALTIMORE ANNAPOLIS BLVD, SUITE 214
 SEVERNA PARK, MD 21146
 www.lenharttraffic.com

**Old Columbia Pike &
National Drive**
(Total Traffic)

Intersection
3

CRITICAL LANE VOLUME (CLV) METHODOLOGY for MSHA

Main Line: Burtonville Elem. School Analyst: Lenhart Traffic Consulting
 Minor Street: MD 198
 Study Period: Existing Traffic

Lane Use + Traffic Volumes

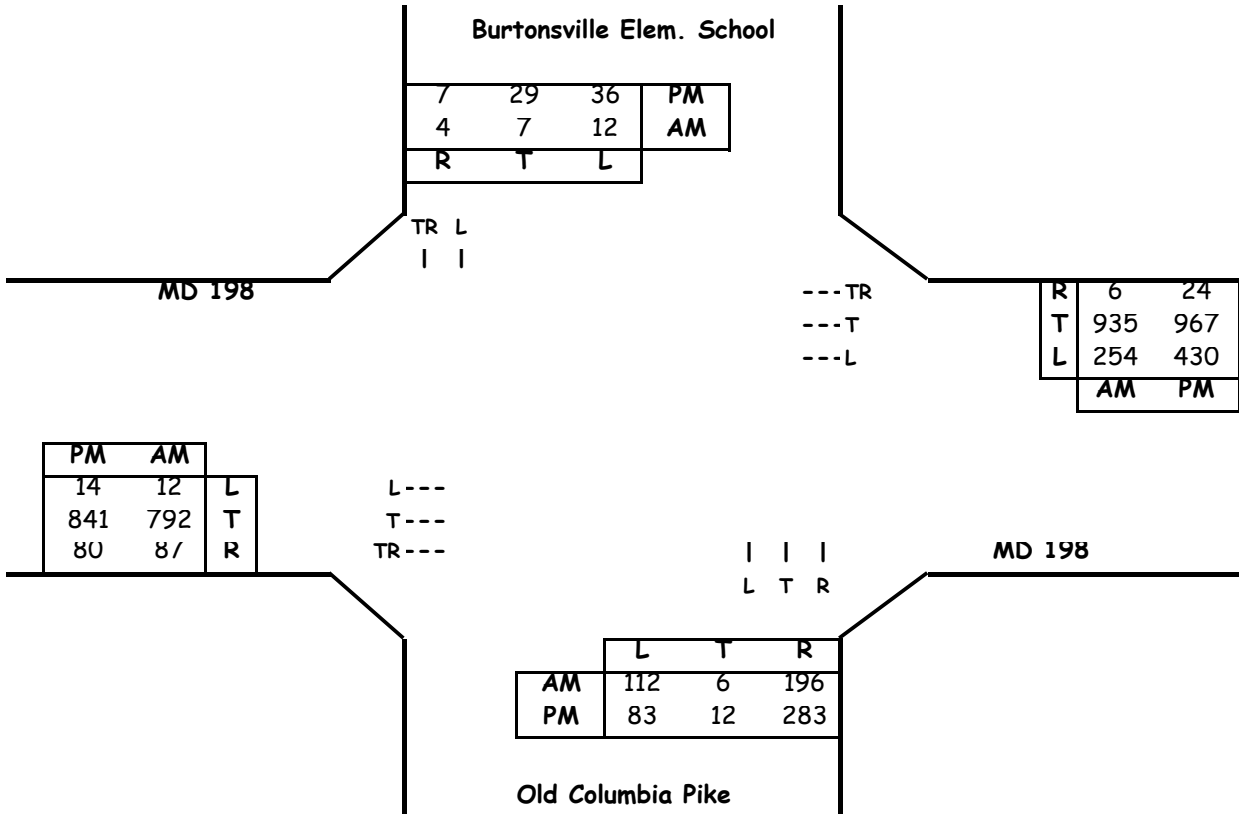

Critical Lane Volume Analysis

Morning Peak Hour							
Dir	Thru Volumes			+ Opposing Lefts			AM CLV
	VOL	x LUF	= Total	VOL	x LUF	= Total	
NB	6	1.00	6	12	1	12	123
SB	11	1.00	11	112	1	112	
EB	879	0.55	483	254	1	254	737
WB	941	0.55	518	12	1	12	
CLV TOTAL=							860
Level of Service (LOS) =							A

Evening Peak Hour							
Dir	Thru Volumes			+ Opposing Lefts			PM CLV
	VOL	x LUF	= Total	VOL	x LUF	= Total	
NB	12	1.00	12	36	1	36	119
SB	36	1.00	36	83	1	83	
EB	921	0.55	507	430	1	430	937
WB	991	0.55	545	14	1	14	
CLV TOTAL=							1056
Level of Service (LOS) =							B

Critical Lane Volume Analysis



LENHART TRAFFIC CONSULTING, INC.
 645 BALTIMORE ANNAPOLIS BLVD, SUITE 214
 SEVERNA PARK, MD 21146
 www.lenharttraffic.com

**Burtonville Elem. School &
 MD 198**
 (Existing Traffic)

Intersection
4

CRITICAL LANE VOLUME (CLV) METHODOLOGY for MSHA

Main Line: Burtonville Elem. School Analyst: Lenhart Traffic Consulting
 Minor Street: MD 198
 Study Period: Background Traffic

Lane Use + Traffic Volumes

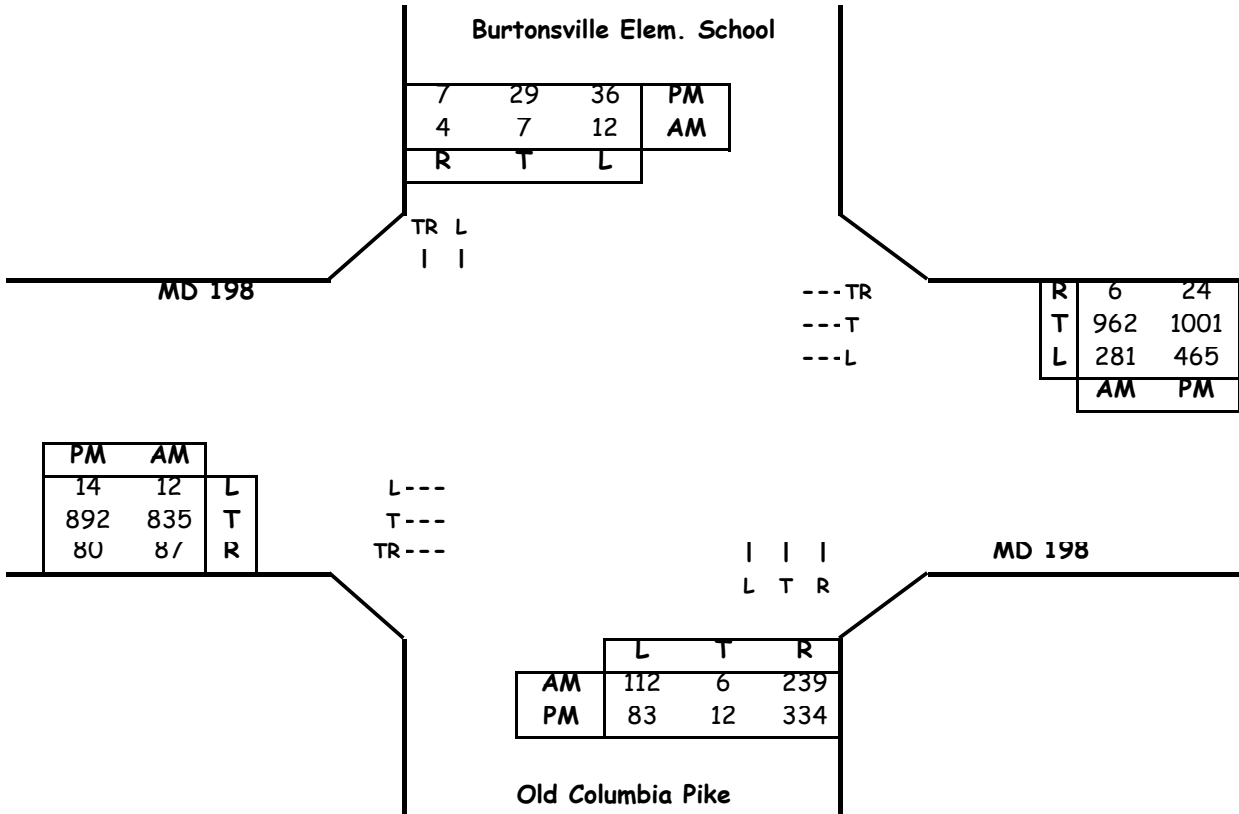

Critical Lane Volume Analysis

Morning Peak Hour							
Dir	Thru Volumes			+ Opposing Lefts			AM CLV
	VOL	x LUF	= Total	VOL	x LUF	= Total	
NB	6	1.00	6	12	1	12	123
SB	11	1.00	11	112	1	112	
EB	922	0.55	507	281	1	281	788
WB	968	0.55	532	12	1	12	
CLV TOTAL=							911
Level of Service (LOS) =							A

Evening Peak Hour							
Dir	Thru Volumes			+ Opposing Lefts			PM CLV
	VOL	x LUF	= Total	VOL	x LUF	= Total	
NB	12	1.00	12	36	1	36	119
SB	36	1.00	36	83	1	83	
EB	972	0.55	535	465	1	465	1000
WB	1025	0.55	564	14	1	14	
CLV TOTAL=							1119
Level of Service (LOS) =							B

Critical Lane Volume Analysis



LENHART TRAFFIC CONSULTING, INC.
 645 BALTIMORE ANNAPOLIS BLVD, SUITE 214
 SEVERNA PARK, MD 21146
 www.lenharttraffic.com

**Burtonville Elem. School &
 MD 198**
 (Background Traffic)

Intersection
4

CRITICAL LANE VOLUME (CLV) METHODOLOGY for MSHA

Main Line: Burtonville Elem. School Analyst: Lenhart Traffic Consulting
 Minor Street: MD 198
 Study Period: Total Traffic

Lane Use + Traffic Volumes

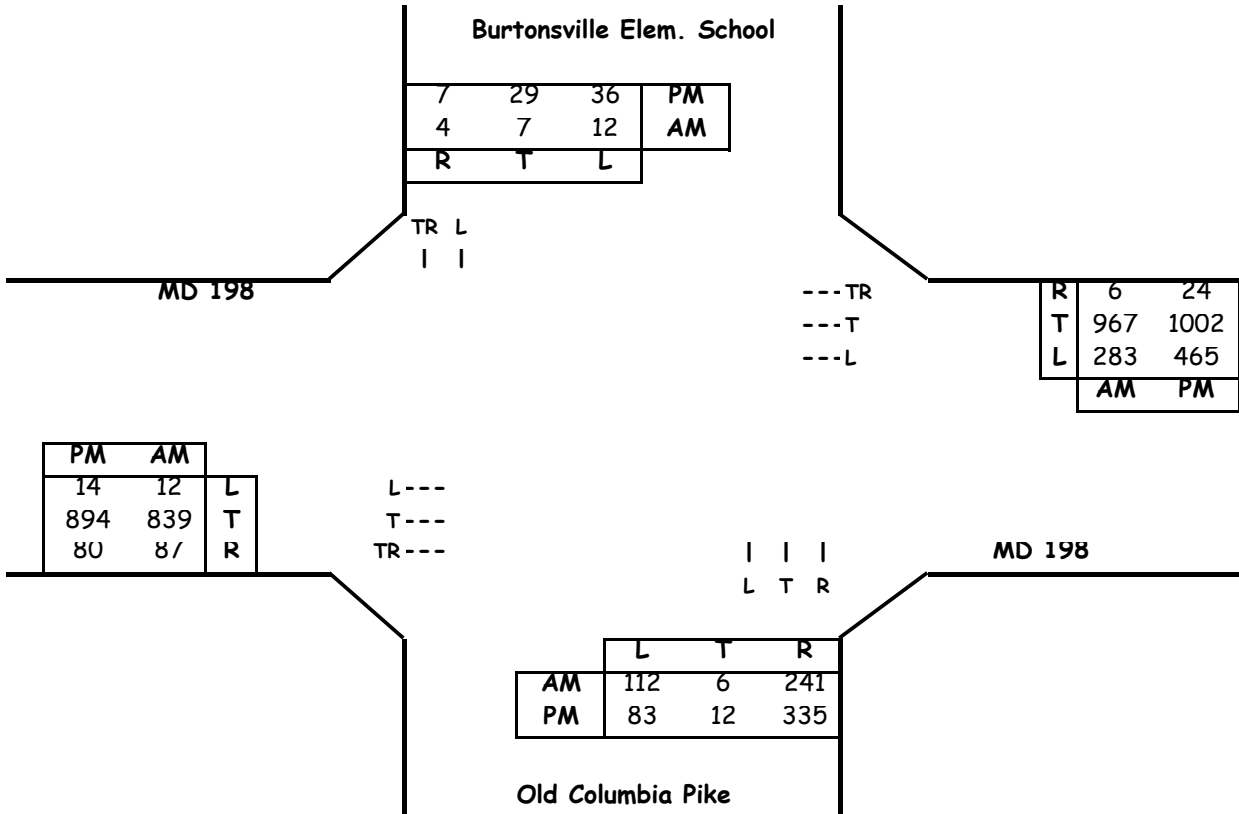

Critical Lane Volume Analysis

Morning Peak Hour							
Dir	Thru Volumes			+ Opposing Lefts			AM CLV
	VOL	x LUF	= Total	VOL	x LUF	= Total	
NB	6	1.00	6	12	1	12	123
SB	11	1.00	11	112	1	112	
EB	926	0.55	509	283	1	283	792
WB	973	0.55	535	12	1	12	
CLV TOTAL=							915
Level of Service (LOS)=							A

Evening Peak Hour							
Dir	Thru Volumes			+ Opposing Lefts			PM CLV
	VOL	x LUF	= Total	VOL	x LUF	= Total	
NB	12	1.00	12	36	1	36	119
SB	36	1.00	36	83	1	83	
EB	974	0.55	536	465	1	465	1001
WB	1026	0.55	564	14	1	14	
CLV TOTAL=							1120
Level of Service (LOS)=							B

Critical Lane Volume Analysis



LENHART TRAFFIC CONSULTING, INC.
 645 BALTIMORE ANNAPOLIS BLVD, SUITE 214
 SEVERNA PARK, MD 21146
 www.lenharttraffic.com

**Burtonville Elem. School &
 MD 198**
 (Total Traffic)

Intersection
4

CRITICAL LANE VOLUME (CLV) METHODOLOGY for MSHA

Intersection of: US 29 SB Off Ramp
and: Blackburn Road
Conditions: Existing Traffic

Analyst: Lenhart Traffic Consulting

Lane Use + Traffic Volumes

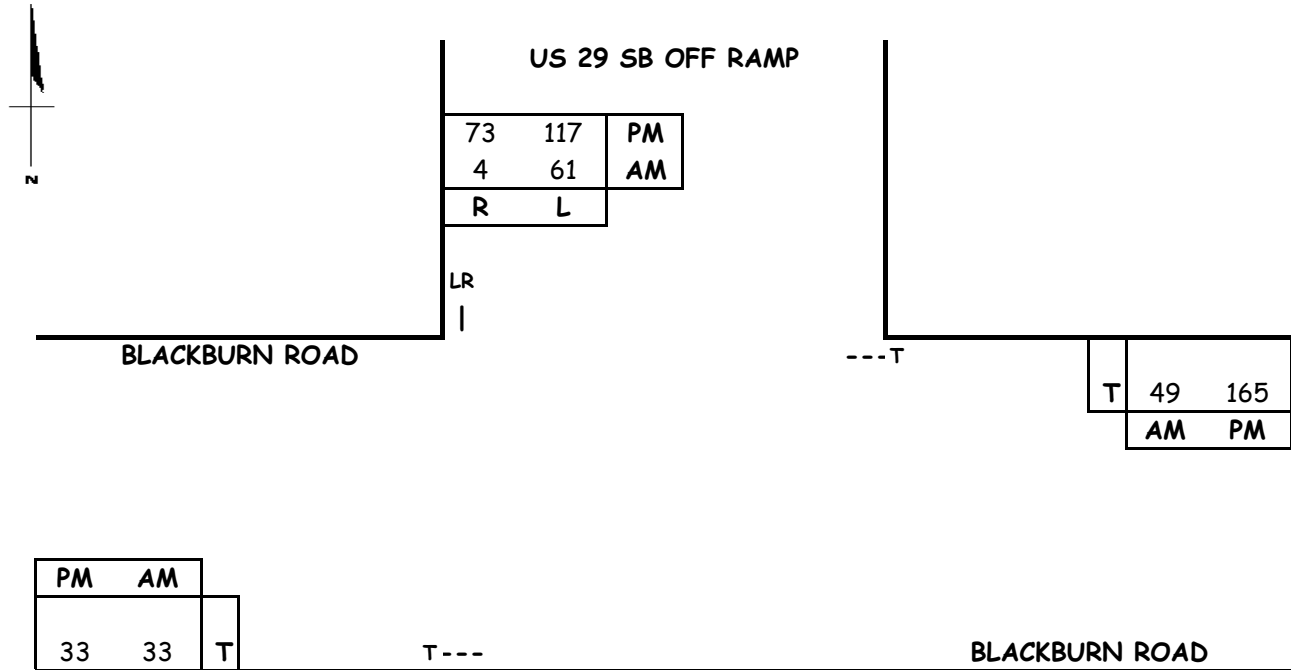

Capacity Analysis

Morning Peak Hour							
Dir	Thru Volumes			+ Opposing Lefts			AM
	VOL	x LUF	= Total	VOL	x LUF	= Total	CLV
SB	65	1.00	65				65
EB	33	1.00	33				49
WB	49	1.00	49	0	0.00	0	
CLV TOTAL=							114
Level of Service (LOS)=							A

Evening Peak Hour							
Dir	Thru Volumes			+ Opposing Lefts			PM
	VOL	x LUF	= Total	VOL	x LUF	= Total	CLV
SB	190	1.00	190				190
EB	33	1.00	33				165
WB	165	1.00	165	0	0.00	0	
CLV TOTAL=							355
Level of Service (LOS)=							A

Critical Lane Volume Analysis



LENHART TRAFFIC CONSULTING, INC.
645 BALTIMORE ANNAPOLIS BLVD, SUITE 214
SEVERNA PARK, MD 21146
www.lenharttraffic.com

US 29 SB Off Ramp &
Blackburn Road
(Existing Traffic)

Intersection
5

CRITICAL LANE VOLUME (CLV) METHODOLOGY for MSHA

Intersection of: US 29 SB Off Ramp
and: Blackburn Road
Conditions: Background Traffic

Analyst: Lenhart Traffic Consulting

Lane Use + Traffic Volumes

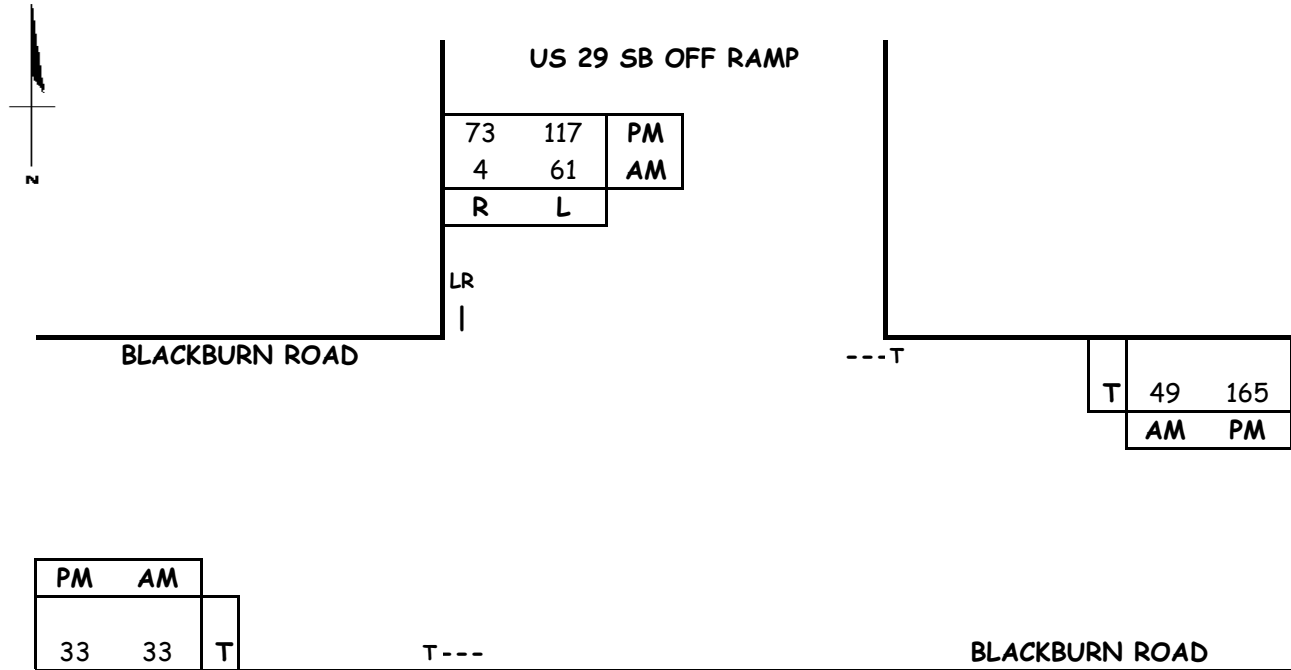

Capacity Analysis

Morning Peak Hour							
Dir	Thru Volumes			+ Opposing Lefts			AM
	VOL	x LUF	= Total	VOL	x LUF	= Total	CLV
SB	65	1.00	65				65
EB	33	1.00	33				49
WB	49	1.00	49	0	0.00	0	
CLV TOTAL=							114
Level of Service (LOS)=							A

Evening Peak Hour							
Dir	Thru Volumes			+ Opposing Lefts			PM
	VOL	x LUF	= Total	VOL	x LUF	= Total	CLV
SB	190	1.00	190				190
EB	33	1.00	33				165
WB	165	1.00	165	0	0.00	0	
CLV TOTAL=							355
Level of Service (LOS)=							A

Critical Lane Volume Analysis



US 29 SB Off Ramp &
Blackburn Road
(Background Traffic)

Intersection
5

CRITICAL LANE VOLUME (CLV) METHODOLOGY for MSHA

Intersection of: US 29 SB Off Ramp
and: Blackburn Road
Conditions: Background Traffic

Analyst: Lenhart Traffic Consulting

Lane Use + Traffic Volumes

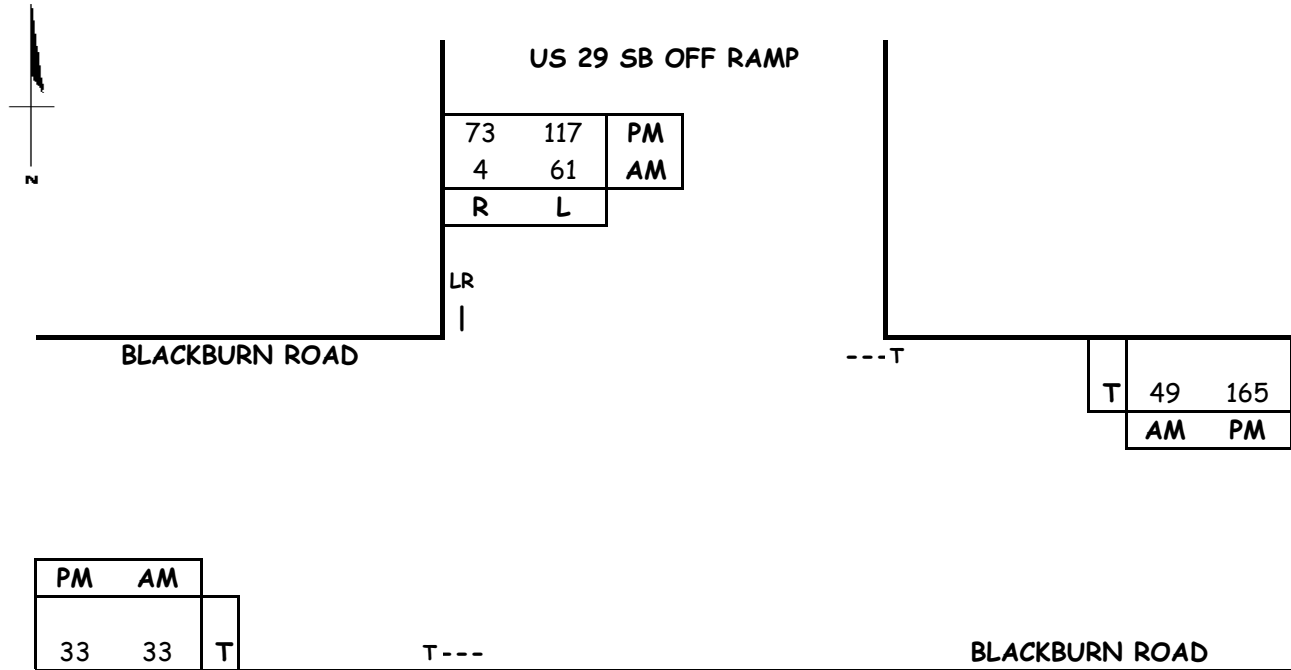

Capacity Analysis

Morning Peak Hour							
Dir	Thru Volumes			+ Opposing Lefts			AM
	VOL	x LUF	= Total	VOL	x LUF	= Total	CLV
SB	65	1.00	65				65
EB	33	1.00	33				49
WB	49	1.00	49	0	0.00	0	
CLV TOTAL=							114
Level of Service (LOS)=							A

Evening Peak Hour							
Dir	Thru Volumes			+ Opposing Lefts			PM
	VOL	x LUF	= Total	VOL	x LUF	= Total	CLV
SB	190	1.00	190				190
EB	33	1.00	33				165
WB	165	1.00	165	0	0.00	0	
CLV TOTAL=							355
Level of Service (LOS)=							A

Critical Lane Volume Analysis



LENHART TRAFFIC CONSULTING, INC.
645 BALTIMORE ANNAPOLIS BLVD, SUITE 214
SEVERNA PARK, MD 21146
www.lenharttraffic.com

US 29 SB Off Ramp &
Blackburn Road
(Background Traffic)

Intersection
5

CRITICAL LANE VOLUME (CLV) METHODOLOGY for MSHA

Main Line: Burtonsville Drive
Minor Street: MD 198
Study Period: Existing Traffic

Analyst: Lenhart Traffic Consulting

Lane Use + Traffic Volumes

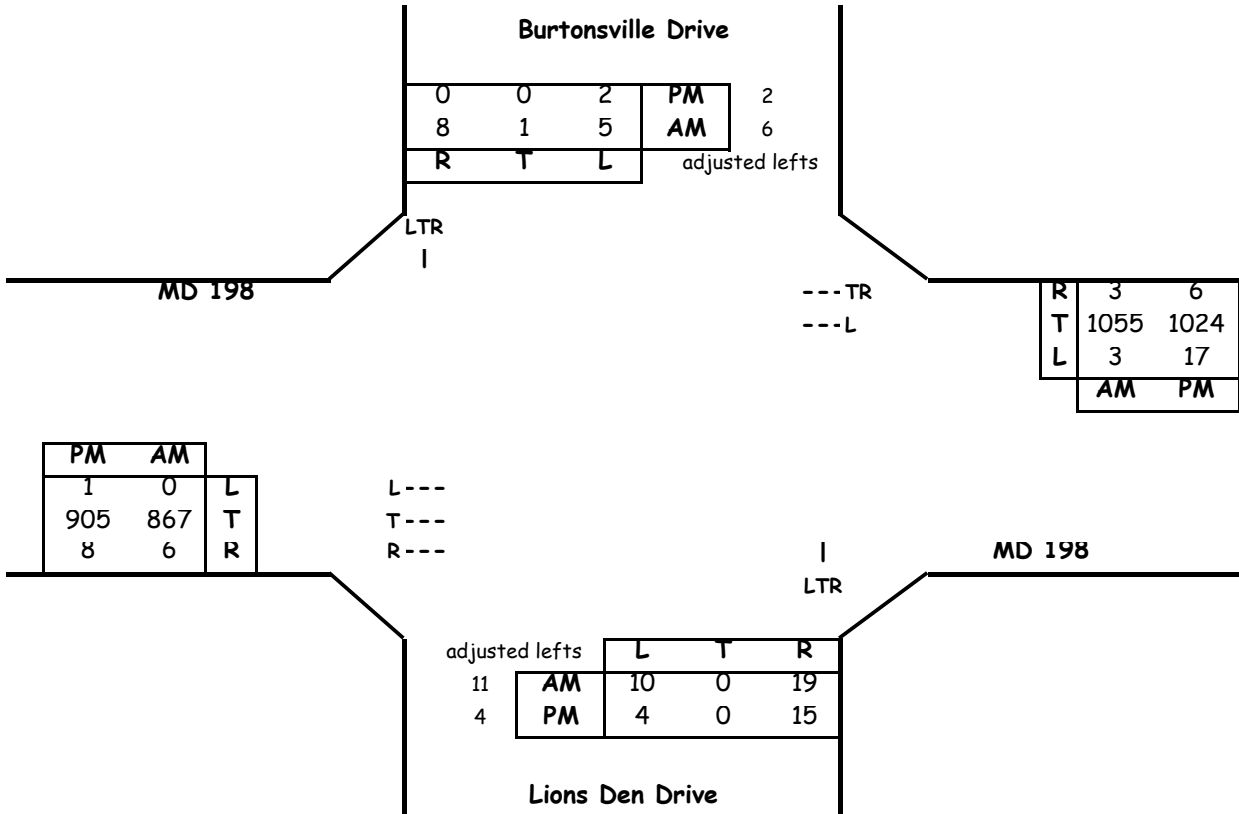

Critical Lane Volume Analysis

Morning Peak Hour							
Dir	Thru Volumes			+ Opposing Lefts			AM CLV
	VOL	x LUF	= Total	VOL	x LUF	= Total	
NB	30	1.00	30	5	1	5	35
SB	15	1.00	15	10	1	10	
EB	867	1	867	3	1	3	
WB	1058	1	1058	0	1	0	
CLV TOTAL=							1093
Level of Service (LOS) =							B

Evening Peak Hour							
Dir	Thru Volumes			+ Opposing Lefts			PM CLV
	VOL	x LUF	= Total	VOL	x LUF	= Total	
NB	19	1.00	19	2	1	2	21
SB	2	1.00	2	4	1	4	
EB	905	1	905	17	1	17	
WB	1030	1	1030	1	1	1	
CLV TOTAL=							1052
Level of Service (LOS) =							B

Critical Lane Volume Analysis



LENHART TRAFFIC CONSULTING, INC.
 645 BALTIMORE ANNAPOLIS BLVD, SUITE 214
 SEVERNA PARK, MD 21146
 www.lenharttraffic.com

**Burtonsville Drive &
MD 198**
 (Existing Traffic)

Intersection
6

CRITICAL LANE VOLUME (CLV) METHODOLOGY for MSHA

Main Line: Burtonsville Drive
Minor Street: MD 198
Study Period: Background Traffic

Analyst: Lenhart Traffic Consulting

Lane Use + Traffic Volumes

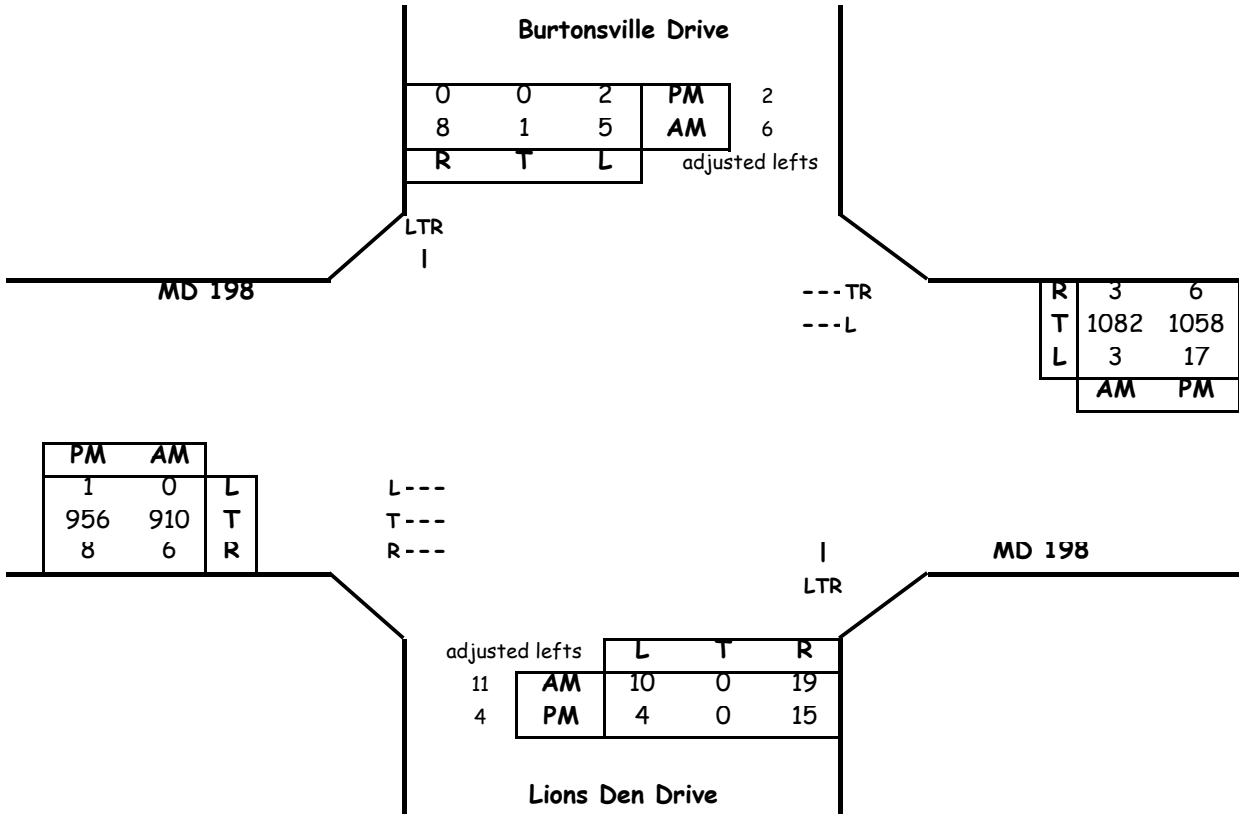

Critical Lane Volume Analysis

Morning Peak Hour							
Dir	Thru Volumes			+ Opposing Lefts			AM CLV
	VOL	x LUF	= Total	VOL	x LUF	= Total	
NB	30	1.00	30	5	1	5	35
SB	15	1.00	15	10	1	10	
EB	910	1	910	3	1	3	
WB	1085	1	1085	0	1	0	
CLV TOTAL=							1120
Level of Service (LOS) =							B

Evening Peak Hour							
Dir	Thru Volumes			+ Opposing Lefts			PM CLV
	VOL	x LUF	= Total	VOL	x LUF	= Total	
NB	19	1.00	19	2	1	2	21
SB	2	1.00	2	4	1	4	
EB	956	1	956	17	1	17	
WB	1064	1	1064	1	1	1	
CLV TOTAL=							1086
Level of Service (LOS) =							B

Critical Lane Volume Analysis



**Burtonsville Drive &
MD 198**
(Background Traffic)

Intersection
6

CRITICAL LANE VOLUME (CLV) METHODOLOGY for MSHA

Main Line: Burtonsville Drive
Minor Street: MD 198
Study Period: Total Traffic

Analyst: Lenhart Traffic Consulting

Lane Use + Traffic Volumes

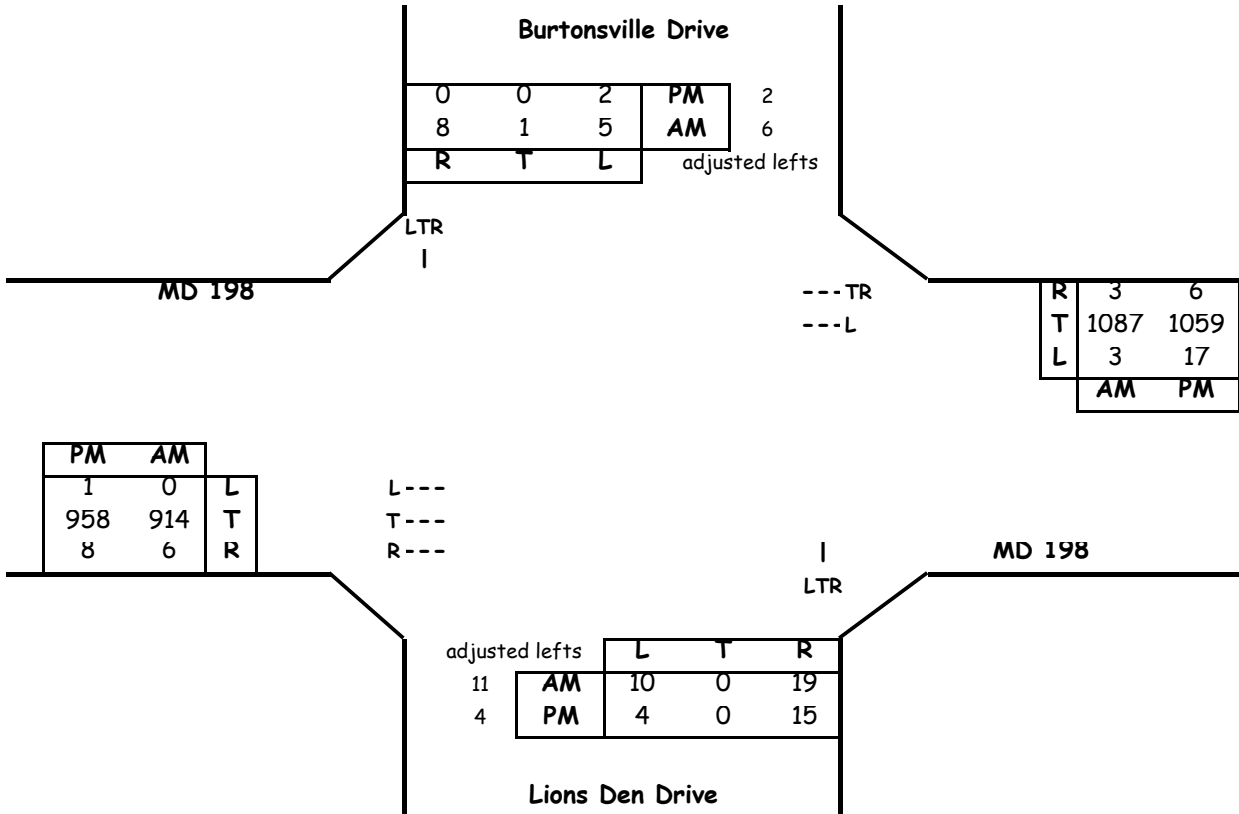

Critical Lane Volume Analysis

Morning Peak Hour							
Dir	Thru Volumes			+ Opposing Lefts			AM CLV
	VOL	x LUF	= Total	VOL	x LUF	= Total	
NB	30	1.00	30	5	1	5	35
SB	15	1.00	15	10	1	10	
EB	914	1	914	3	1	3	
WB	1090	1	1090	0	1	0	
CLV TOTAL=							1125
Level of Service (LOS)=							B

Evening Peak Hour							
Dir	Thru Volumes			+ Opposing Lefts			PM CLV
	VOL	x LUF	= Total	VOL	x LUF	= Total	
NB	19	1.00	19	2	1	2	21
SB	2	1.00	2	4	1	4	
EB	958	1	958	17	1	17	
WB	1065	1	1065	1	1	1	
CLV TOTAL=							1087
Level of Service (LOS)=							B

Critical Lane Volume Analysis



LENHART TRAFFIC CONSULTING, INC.
 645 BALTIMORE ANNAPOLIS BLVD, SUITE 214
 SEVERNA PARK, MD 21146
 www.lenharttraffic.com

**Burtonsville Drive &
 MD 198**
 (Total Traffic)

Intersection
6

CRITICAL LANE VOLUME (CLV) METHODOLOGY for MSHA

Main Line: Old Columbia Pike
Minor Street: Greencastle Road
Study Period: Existing Traffic

Analyst: Lenhart Traffic Consulting

Lane Use + Traffic Volumes

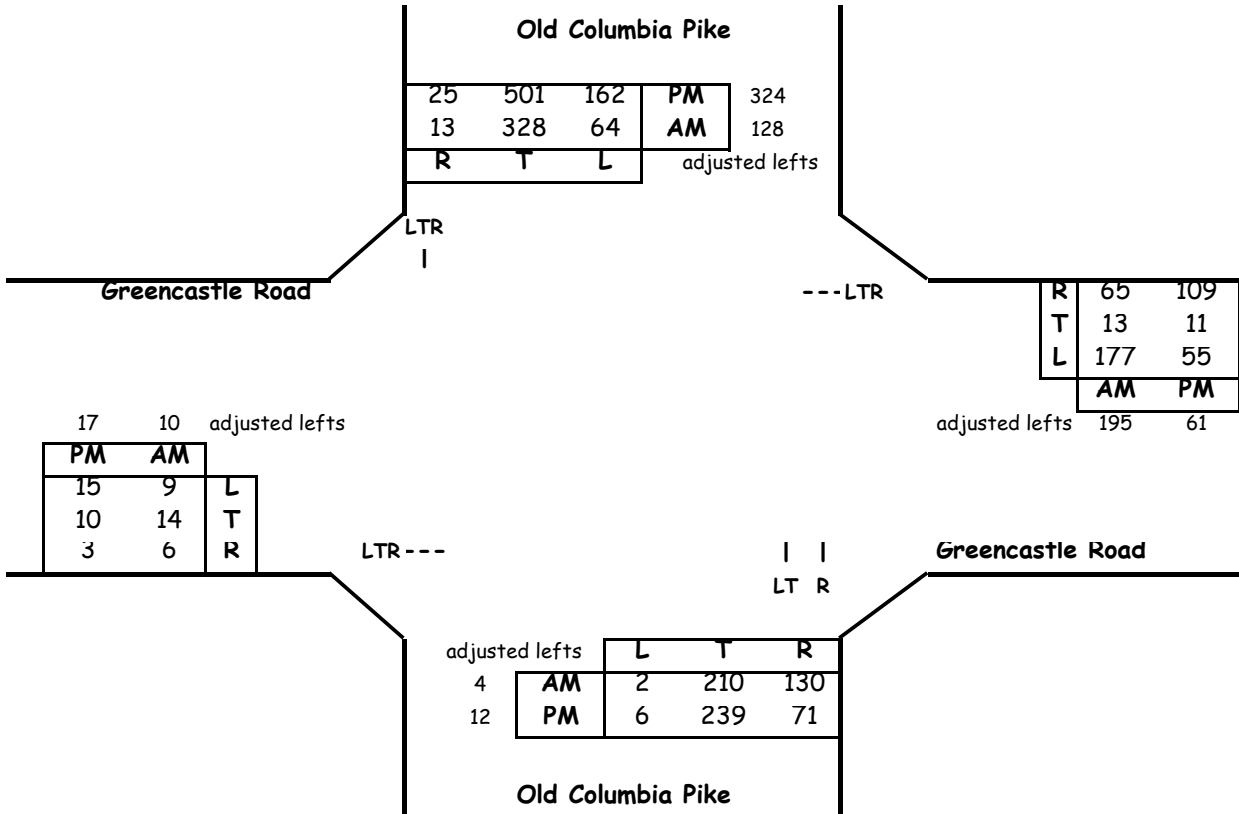

Critical Lane Volume Analysis

Morning Peak Hour							
Dir	Thru Volumes			+ Opposing Lefts			AM CLV
	VOL	x LUF	= Total	VOL	x LUF	= Total	
NB	214	1.00	214	64	1	64	471
SB	469	1.00	469	2	1	2	
EB	30	1	30	177	1	177	282
WB	273	1	273	9	1	9	
CLV TOTAL=							753
Level of Service (LOS)=							A

Evening Peak Hour							
Dir	Thru Volumes			+ Opposing Lefts			PM CLV
	VOL	x LUF	= Total	VOL	x LUF	= Total	
NB	251	1.00	251	162	1	162	856
SB	850	1.00	850	6	1	6	
EB	30	1	30	55	1	55	196
WB	181	1	181	15	1	15	
CLV TOTAL=							1052
Level of Service (LOS)=							B

Critical Lane Volume Analysis



LENHART TRAFFIC CONSULTING, INC.
 645 BALTIMORE ANNAPOLIS BLVD, SUITE 214
 SEVERNA PARK, MD 21146
 www.lenharttraffic.com

**Old Columbia Pike &
Greencastle Road**
(Existing Traffic)

Intersection
7

CRITICAL LANE VOLUME (CLV) METHODOLOGY for MSHA

Main Line: Old Columbia Pike
Minor Street: Greencastle Road
Study Period: Background Traffic

Analyst: Lenhart Traffic Consulting

Lane Use + Traffic Volumes

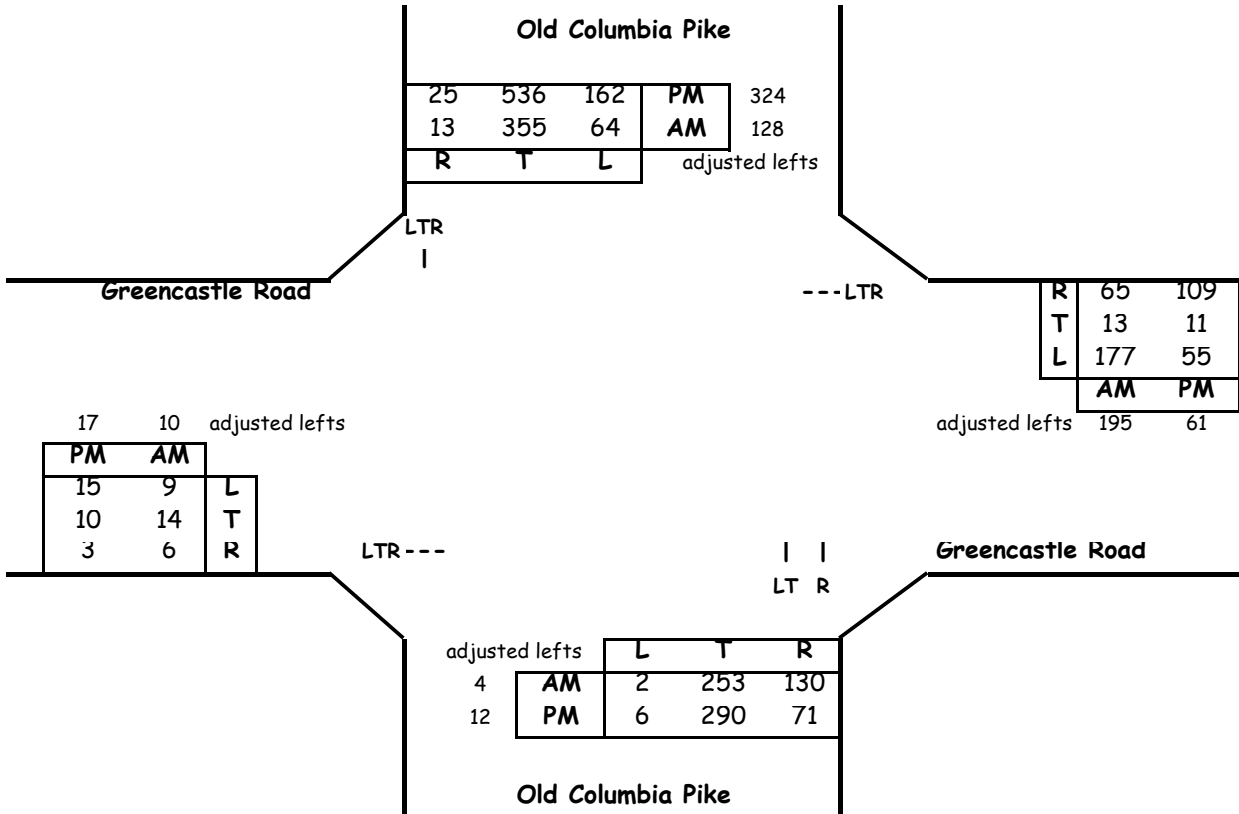

Critical Lane Volume Analysis

Morning Peak Hour							
Dir	Thru Volumes			+ Opposing Lefts			AM CLV
	VOL	x LUF	= Total	VOL	x LUF	= Total	
NB	257	1.00	257	64	1	64	498
SB	496	1.00	496	2	1	2	
EB	30	1	30	177	1	177	282
WB	273	1	273	9	1	9	
CLV TOTAL=							780
Level of Service (LOS) =							A

Evening Peak Hour							
Dir	Thru Volumes			+ Opposing Lefts			PM CLV
	VOL	x LUF	= Total	VOL	x LUF	= Total	
NB	302	1.00	302	162	1	162	891
SB	885	1.00	885	6	1	6	
EB	30	1	30	55	1	55	196
WB	181	1	181	15	1	15	
CLV TOTAL=							1087
Level of Service (LOS) =							B

Critical Lane Volume Analysis



LENHART TRAFFIC CONSULTING, INC.
 645 BALTIMORE ANNAPOLIS BLVD, SUITE 214
 SEVERNA PARK, MD 21146
 www.lenharttraffic.com

**Old Columbia Pike &
Greencastle Road**
(Background Traffic)

Intersection
7

CRITICAL LANE VOLUME (CLV) METHODOLOGY for MSHA

Main Line: Old Columbia Pike
Minor Street: Greencastle Road
Study Period: Total Traffic

Analyst: Lenhart Traffic Consulting

Lane Use + Traffic Volumes

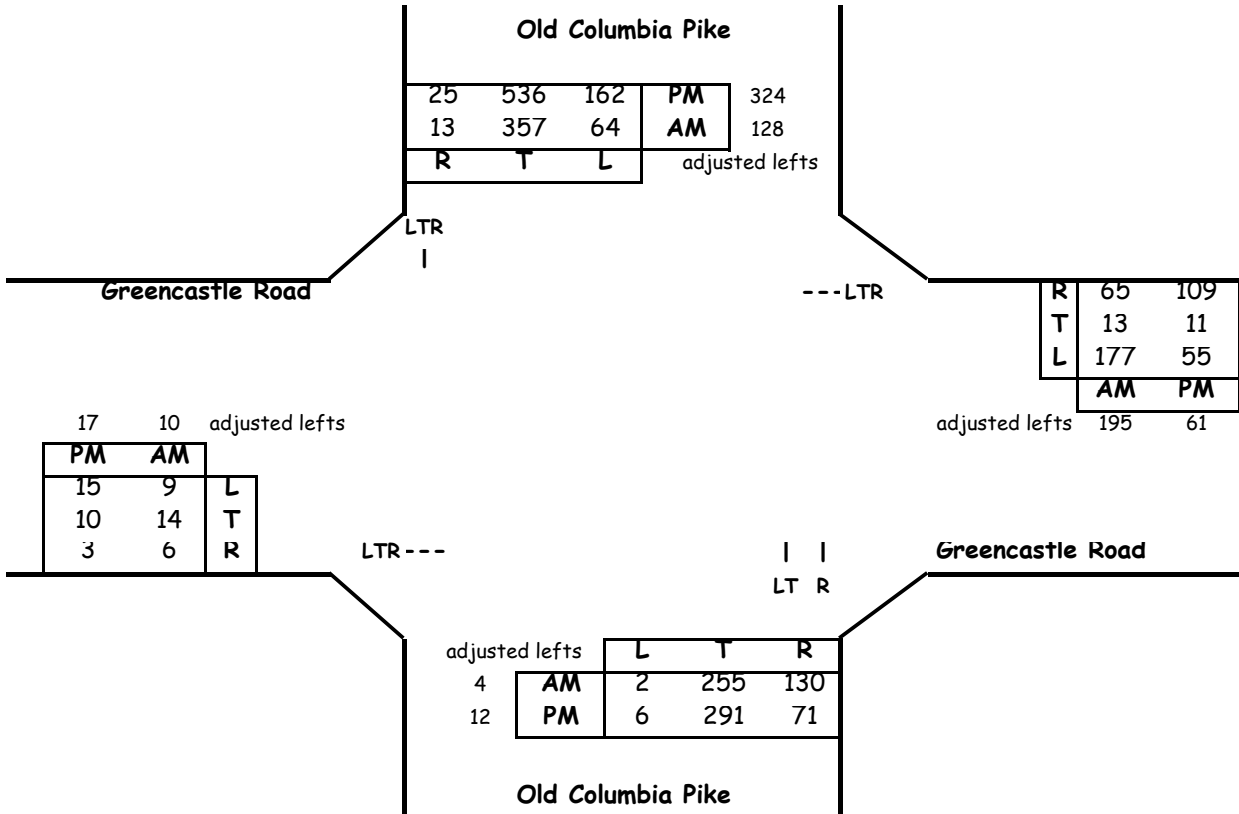

Critical Lane Volume Analysis

Morning Peak Hour							
Dir	Thru Volumes			+ Opposing Lefts			AM CLV
	VOL	x LUF	= Total	VOL	x LUF	= Total	
NB	259	1.00	259	64	1	64	500
SB	498	1.00	498	2	1	2	
EB	30	1	30	177	1	177	282
WB	273	1	273	9	1	9	
CLV TOTAL=							782
Level of Service (LOS)=							A

Evening Peak Hour							
Dir	Thru Volumes			+ Opposing Lefts			PM CLV
	VOL	x LUF	= Total	VOL	x LUF	= Total	
NB	303	1.00	303	162	1	162	891
SB	885	1.00	885	6	1	6	
EB	30	1	30	55	1	55	196
WB	181	1	181	15	1	15	
CLV TOTAL=							1087
Level of Service (LOS)=							B

Critical Lane Volume Analysis



LENHART TRAFFIC CONSULTING, INC.
 645 BALTIMORE ANNAPOLIS BLVD, SUITE 214
 SEVERNA PARK, MD 21146
 www.lenharttraffic.com

**Old Columbia Pike &
 Greencastle Road**
 (Total Traffic)

Intersection
7

CRITICAL LANE VOLUME (CLV) METHODOLOGY for MSHA

Main Line: Shopping Center
Minor Street: MD 198
Study Period: Existing Traffic

Analyst: Lenhart Traffic Consulting

Lane Use + Traffic Volumes

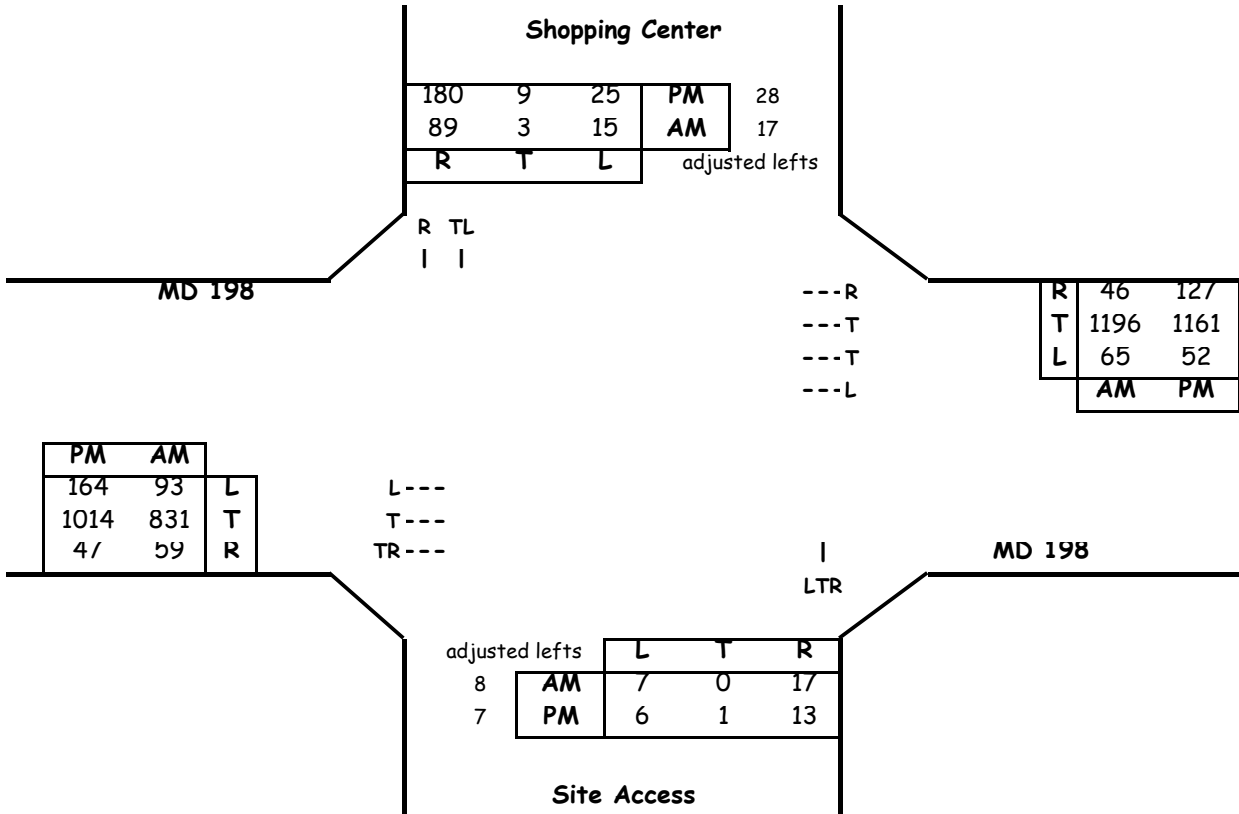

Critical Lane Volume Analysis

Morning Peak Hour							
Dir	Thru Volumes			+ Opposing Lefts			AM CLV
	VOL	x LUF	= Total	VOL	x LUF	= Total	
NB	25	1.00	25	15	1	15	40
SB	20	1.00	20	7	1	7	
EB	890	0.55	490	65	1	65	751
WB	1196	0.55	658	93	1	93	
CLV TOTAL=							791
Level of Service (LOS) =							A

Evening Peak Hour							
Dir	Thru Volumes			+ Opposing Lefts			PM CLV
	VOL	x LUF	= Total	VOL	x LUF	= Total	
NB	21	1.00	21	25	1	25	46
SB	37	1.00	37	6	1	6	
EB	1061	0.55	584	52	1	52	803
WB	1161	0.55	639	164	1	164	
CLV TOTAL=							849
Level of Service (LOS) =							A

Critical Lane Volume Analysis



**Shopping Center &
MD 198**
(Existing Traffic)

Intersection
8

CRITICAL LANE VOLUME (CLV) METHODOLOGY for MSHA

Main Line: Shopping Center
Minor Street: MD 198
Study Period: Background Traffic

Analyst: Lenhart Traffic Consulting

Lane Use + Traffic Volumes

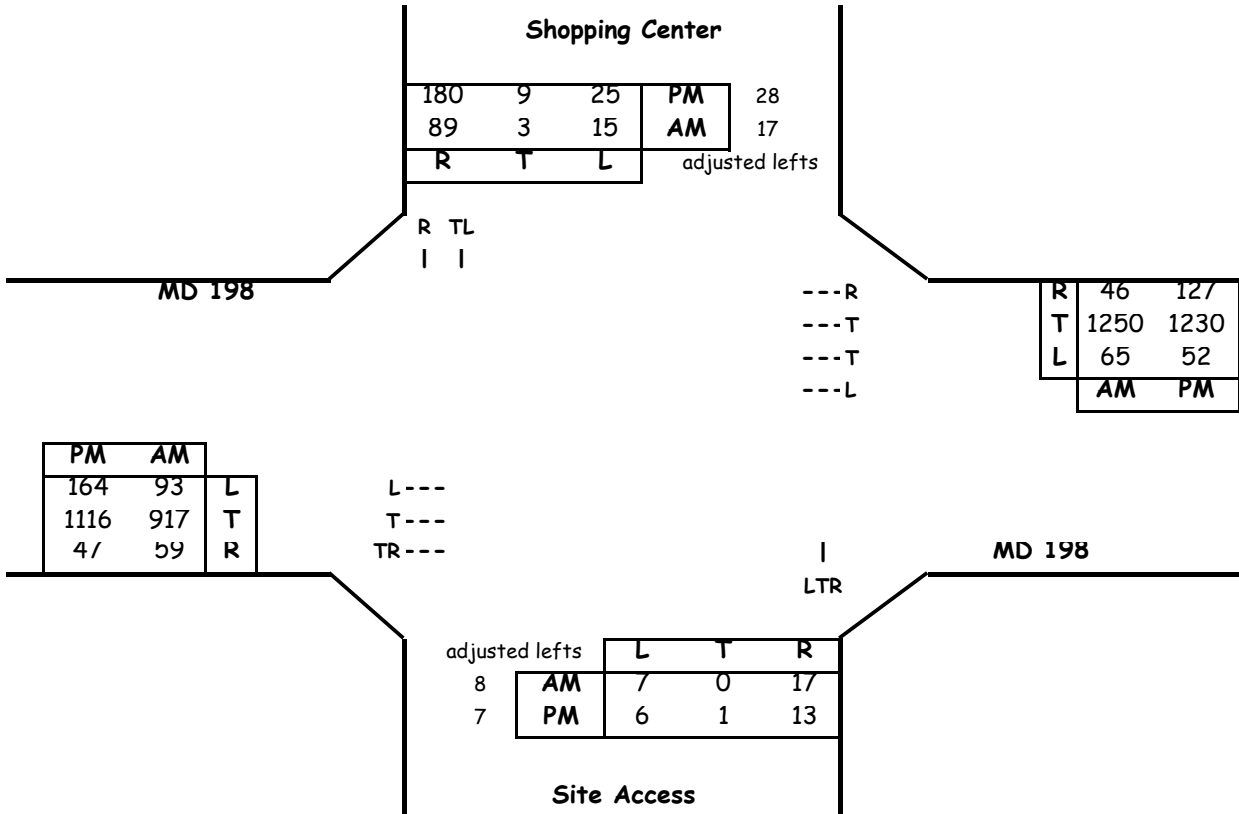

Critical Lane Volume Analysis

Morning Peak Hour							
Dir	Thru Volumes			+ Opposing Lefts			AM CLV
	VOL	x LUF	= Total	VOL	x LUF	= Total	
NB	25	1.00	25	15	1	15	40
SB	20	1.00	20	7	1	7	
EB	976	0.55	537	65	1	65	781
WB	1250	0.55	688	93	1	93	
CLV TOTAL=							821
Level of Service (LOS) =							A

Evening Peak Hour							
Dir	Thru Volumes			+ Opposing Lefts			PM CLV
	VOL	x LUF	= Total	VOL	x LUF	= Total	
NB	21	1.00	21	25	1	25	46
SB	37	1.00	37	6	1	6	
EB	1163	0.55	640	52	1	52	841
WB	1230	0.55	677	164	1	164	
CLV TOTAL=							887
Level of Service (LOS) =							A

Critical Lane Volume Analysis



**Shopping Center &
MD 198**
(Background Traffic)

Intersection
8

CRITICAL LANE VOLUME (CLV) METHODOLOGY for MSHA

Main Line: Shopping Center
Minor Street: MD 198
Study Period: Total Traffic

Analyst: Lenhart Traffic Consulting

Lane Use + Traffic Volumes

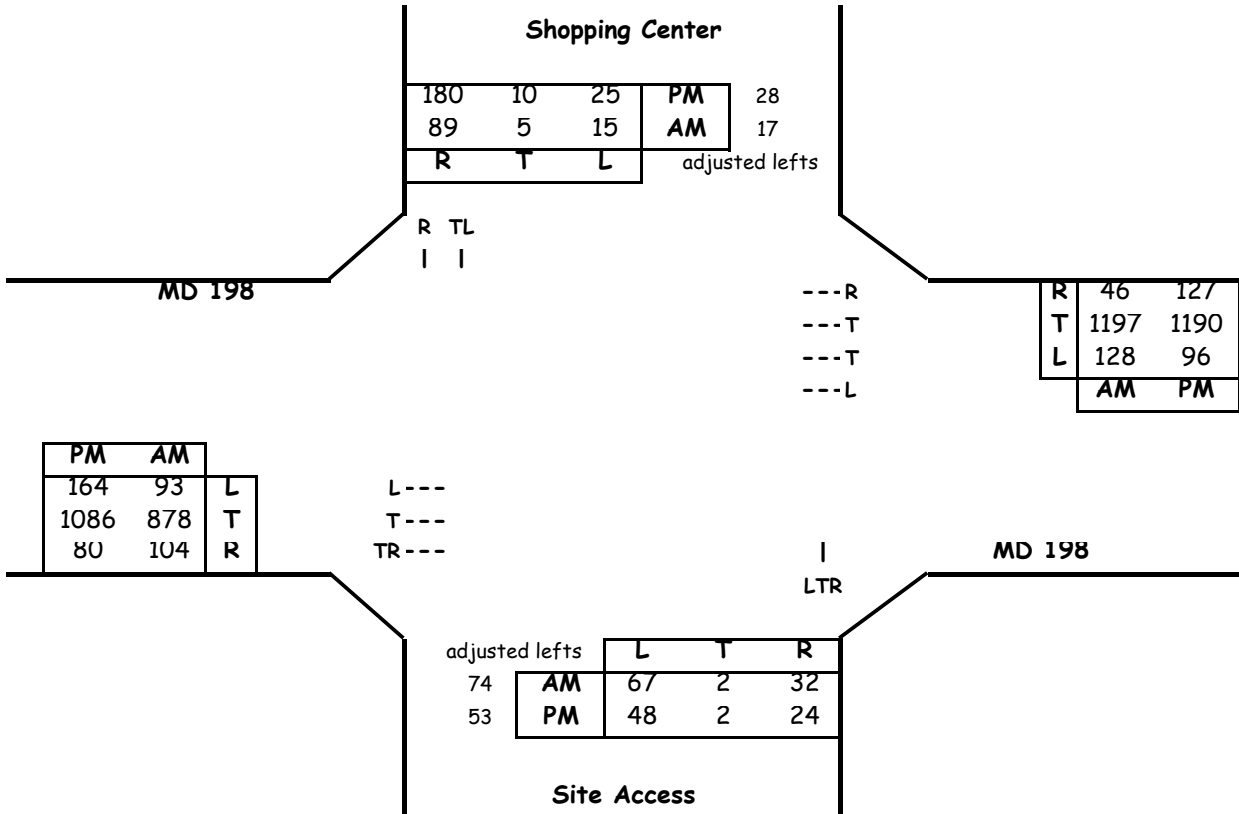

Critical Lane Volume Analysis

Morning Peak Hour							
Dir	Thru Volumes			+ Opposing Lefts			AM CLV
	VOL	x LUF	= Total	VOL	x LUF	= Total	
NB	108	1.00	108	15	1	15	123
SB	22	1.00	22	67	1	67	
EB	982	0.55	540	128	1	128	751
WB	1197	0.55	658	93	1	93	
CLV TOTAL=							874
Level of Service (LOS) =							A

Evening Peak Hour							
Dir	Thru Volumes			+ Opposing Lefts			PM CLV
	VOL	x LUF	= Total	VOL	x LUF	= Total	
NB	79	1.00	79	25	1	25	104
SB	38	1.00	38	48	1	48	
EB	1166	0.55	641	96	1	96	819
WB	1190	0.55	655	164	1	164	
CLV TOTAL=							923
Level of Service (LOS) =							A

Critical Lane Volume Analysis



LENHART TRAFFIC CONSULTING, INC.
 645 BALTIMORE ANNAPOLIS BLVD, SUITE 214
 SEVERNA PARK, MD 21146
 www.lenharttraffic.com

**Shopping Center &
MD 198**
(Total Traffic)

Intersection
8

Critical Lane Volume (CLV) Methodology for MSHA

Main Line: MD 198
Minor Street: Site Access
Study Period: Existing Traffic

Analyst: Lenhart Traffic Consulting

MD 198

PM	AM	
1067	899	T
2	2	R

T---
T---
TR---

MD 198

Site Access

	L	R
AM	0	81
PM	0	86

Critical Lane Volume Analysis

Morning Peak Hour							
Dir	Thru Volumes			+ Opposing Lefts			AM CLV
	VOL	x LUF	= Total	VOL	x LUF	= Total	
NB	81	1.00	81				81
EB	901	0.40	360	0	0.00	0	360
WB	0	0.00	0				
CLV TOTAL=							441
Level of Service (LOS) =							A

Evening Peak Hour							
Dir	Thru Volumes			+ Opposing Lefts			PM CLV
	VOL	x LUF	= Total	VOL	x LUF	= Total	
NB	86	1.00	86				86
EB	1069	0.40	428	0	0.00	0	428
WB	0	0.00	0				
CLV TOTAL=							514
Level of Service (LOS) =							A

Critical Lane Volume Analysis



LENHART TRAFFIC CONSULTING, INC.
645 BALTIMORE ANNAPOLIS BLVD, SUITE 214
SEVERNA PARK, MD 21146
www.lenharttraffic.com

**MD 198 &
Site Access
(Existing Traffic)**

Intersection
9

Critical Lane Volume (CLV) Methodology for MSHA

Main Line: MD 198
Minor Street: Site Access
Study Period: Background Traffic

Analyst: Lenhart Traffic Consulting

MD 198

PM	AM	
1169	985	T
2	2	R

T---
T---
TR---

MD 198

Site Access

	L	R
AM	0	81
PM	0	86

Critical Lane Volume Analysis

Morning Peak Hour						
Dir	Thru Volumes			+ Opposing Lefts		AM
	VOL	x LUF	= Total	VOL	x LUF = Total	CLV
NB	81	1.00	81			81
EB	987	0.40	395	0	0.00 0	395
WB	0	0.00	0			
CLV TOTAL=						476
Level of Service (LOS) =						A

Evening Peak Hour						
Dir	Thru Volumes			+ Opposing Lefts		PM
	VOL	x LUF	= Total	VOL	x LUF = Total	CLV
NB	86	1.00	86			86
EB	1171	0.40	468	0	0.00 0	468
WB	0	0.00	0			
CLV TOTAL=						554
Level of Service (LOS) =						A

Critical Lane Volume Analysis



LENHART TRAFFIC CONSULTING, INC.
645 BALTIMORE ANNAPOLIS BLVD, SUITE 214
SEVERNA PARK, MD 21146
www.lenharttraffic.com

**MD 198 &
Site Access
(Background Traffic)**

Intersection
9

Critical Lane Volume (CLV) Methodology for MSHA

Main Line: MD 198
Minor Street: Site Access
Study Period: Total Traffic

Analyst: Lenhart Traffic Consulting

MD 198

PM	AM	
1169	987	T
12	16	R

T---
T---
TR---

MD 198

	L	R
AM	0	128
PM	0	117

Site Access

Critical Lane Volume Analysis

Morning Peak Hour							
Dir	Thru Volumes			+ Opposing Lefts			AM
	VOL	x LUF	= Total	VOL	x LUF	= Total	CLV
NB	128	1.00	128				128
EB	1003	0.40	401	0	0.00	0	401
WB	0	0.00	0				
CLV TOTAL=							529
Level of Service (LOS) =							A

Evening Peak Hour							
Dir	Thru Volumes			+ Opposing Lefts			PM
	VOL	x LUF	= Total	VOL	x LUF	= Total	CLV
NB	117	1.00	117				117
EB	1181	0.40	472	0	0.00	0	472
WB	0	0.00	0				
CLV TOTAL=							589
Level of Service (LOS) =							A

Critical Lane Volume Analysis



LENHART TRAFFIC CONSULTING, INC.
645 BALTIMORE ANNAPOLIS BLVD, SUITE 214
SEVERNA PARK, MD 21146
www.lenharttraffic.com

**MD 198 &
Site Access
(Total Traffic)**

Intersection
9

Intersection: 1: US 29 NB Off Ramp/US 29 NB On Ramp & MD 198

Movement	EB	EB	EB	EB	EB	WB	WB	WB	WB	NB	NB
Directions Served	L	L	T	T	T	T	T	T	R	L	LT
Maximum Queue (ft)	159	171	186	198	213	278	311	266	106	141	203
Average Queue (ft)	87	99	97	120	140	154	187	141	43	45	91
95th Queue (ft)	147	154	164	185	204	247	270	235	82	105	169
Link Distance (ft)			879	879	879	804	804	804	804	430	430
Upstream Blk Time (%)											
Queuing Penalty (veh)											
Storage Bay Dist (ft)	475	475									
Storage Blk Time (%)											
Queuing Penalty (veh)											

Intersection: 2: Old Columbia Pike & MD 198

Movement	EB	EB	EB	EB	EB	WB	WB	WB	WB	WB	SB	SB
Directions Served	L	T	T	T	R	L	L	T	T	R	L	L
Maximum Queue (ft)	177	219	185	179	79	172	167	411	406	93	138	137
Average Queue (ft)	139	154	110	105	7	82	99	280	262	3	74	84
95th Queue (ft)	193	235	179	169	41	147	155	386	364	65	124	130
Link Distance (ft)		178	178	178	178		879	879	879			410
Upstream Blk Time (%)	9	16	0	0								
Queuing Penalty (veh)	0	42	1	1								
Storage Bay Dist (ft)	200					450				450	260	
Storage Blk Time (%)	9	16								0		
Queuing Penalty (veh)	23	27								0		

Intersection: 2: Old Columbia Pike & MD 198

Movement	SB	SB
Directions Served	LT	T
Maximum Queue (ft)	150	133
Average Queue (ft)	94	59
95th Queue (ft)	140	121
Link Distance (ft)	410	410
Upstream Blk Time (%)		
Queuing Penalty (veh)		
Storage Bay Dist (ft)		
Storage Blk Time (%)		
Queuing Penalty (veh)		

Intersection: 3: Old Columbia Pike & National Drive

Movement	EB	EB	WB	WB	NB	NB	NB	NB	NB	SB	SB	SB	
Directions Served	LT	R	L	TR	L	T	T	T	R	L	T	T	
Maximum Queue (ft)	94	112	154	18	165	44	66	59	80	34	102	78	
Average Queue (ft)	32	47	72	1	79	9	15	13	31	3	36	22	
95th Queue (ft)	73	83	130	9	146	32	48	42	66	19	75	57	
Link Distance (ft)	443	443	414	414		410	410	410	410		884	884	
Upstream Blk Time (%)													
Queuing Penalty (veh)													
Storage Bay Dist (ft)					160					400			
Storage Blk Time (%)					1								
Queuing Penalty (veh)					0								

Intersection: 3: Old Columbia Pike & National Drive

Movement	SB	SB
Directions Served	T	R
Maximum Queue (ft)	116	47
Average Queue (ft)	50	12
95th Queue (ft)	101	37
Link Distance (ft)	884	
Upstream Blk Time (%)		
Queuing Penalty (veh)		
Storage Bay Dist (ft)	400	
Storage Blk Time (%)		
Queuing Penalty (veh)		

Intersection: 4: Old Columbia Pike & MD 198

Movement	EB	EB	EB	WB	WB	WB	NB	NB	NB	SB	SB	
Directions Served	L	T	TR	L	T	TR	L	T	R	L	TR	
Maximum Queue (ft)	89	294	303	175	440	418	150	90	73	38	28	
Average Queue (ft)	9	143	143	134	198	196	74	6	18	7	4	
95th Queue (ft)	39	247	245	212	378	374	134	38	60	25	16	
Link Distance (ft)		3434	3434		1102	1102		568			333	
Upstream Blk Time (%)												
Queuing Penalty (veh)												
Storage Bay Dist (ft)	100				150				160	50	75	
Storage Blk Time (%)		13		7	16		0	0	2			
Queuing Penalty (veh)		2		36	44		0	0	2			

Intersection: 5: Blackburn Road & US 29 SB Off Ramp

Movement	SB
Directions Served	LR
Maximum Queue (ft)	60
Average Queue (ft)	30
95th Queue (ft)	51
Link Distance (ft)	310
Upstream Blk Time (%)	
Queuing Penalty (veh)	
Storage Bay Dist (ft)	
Storage Blk Time (%)	
Queuing Penalty (veh)	

Intersection: 6: Lions Den Drive/Burtonsville Drive & MD 198

Movement	WB	WB	NB	SB
Directions Served	L	TR	LTR	LTR
Maximum Queue (ft)	22	711	108	57
Average Queue (ft)	1	47	37	18
95th Queue (ft)	11	720	98	46
Link Distance (ft)		3434	531	564
Upstream Blk Time (%)		0		
Queuing Penalty (veh)		1		
Storage Bay Dist (ft)	140			
Storage Blk Time (%)				
Queuing Penalty (veh)				

Intersection: 7: Old Columbia Pike & Greencastle Road

Movement	EB	WB	NB	NB	SB
Directions Served	LTR	LTR	LT	R	LTR
Maximum Queue (ft)	52	153	128	70	232
Average Queue (ft)	14	74	47	26	96
95th Queue (ft)	41	132	95	56	173
Link Distance (ft)	592	678	1027		686
Upstream Blk Time (%)					
Queuing Penalty (veh)					
Storage Bay Dist (ft)				500	
Storage Blk Time (%)					
Queuing Penalty (veh)					

Intersection: 8: Site Access/Shopping Center & MD 198

Movement	EB	EB	EB	WB	NB	SB	SB
Directions Served	L	T	TR	L	LTR	LT	R
Maximum Queue (ft)	112	101	82	55	58	49	137
Average Queue (ft)	36	8	4	14	18	15	46
95th Queue (ft)	80	60	44	36	47	42	97
Link Distance (ft)		1102	1102		238	276	276
Upstream Blk Time (%)							
Queuing Penalty (veh)							
Storage Bay Dist (ft)	150			140			
Storage Blk Time (%)		0					
Queuing Penalty (veh)		0					

Intersection: 9: Site Access & MD 198

Movement	EB	EB	EB	WB	WB	WB	NB
Directions Served	T	T	TR	T	T	T	R
Maximum Queue (ft)	188	147	44	152	190	160	142
Average Queue (ft)	52	16	1	19	24	11	49
95th Queue (ft)	158	92	19	88	107	75	109
Link Distance (ft)	172	172	172	178	178	178	130
Upstream Blk Time (%)	2	0		0	0	0	5
Queuing Penalty (veh)	7	0		0	1	0	0
Storage Bay Dist (ft)							
Storage Blk Time (%)							
Queuing Penalty (veh)							

Network Summary

Network wide Queuing Penalty: 188

Intersection: 1: US 29 NB Off Ramp/US 29 NB On Ramp & MD 198

Movement	EB	EB	EB	EB	EB	WB	WB	WB	WB	NB	NB
Directions Served	L	L	T	T	T	T	T	T	R	L	LT
Maximum Queue (ft)	149	162	182	181	189	338	377	338	130	110	178
Average Queue (ft)	73	88	89	101	114	222	260	215	54	38	76
95th Queue (ft)	128	141	152	154	171	315	352	303	98	88	151
Link Distance (ft)			879	879	879	804	804	804	804	432	432
Upstream Blk Time (%)											
Queuing Penalty (veh)											
Storage Bay Dist (ft)	475	475									
Storage Blk Time (%)											
Queuing Penalty (veh)											

Intersection: 2: Old Columbia Pike & MD 198

Movement	EB	EB	EB	EB	WB	WB	WB	WB	SB	SB	SB	SB
Directions Served	L	T	T	TR	L	L	T	T	L	L	LT	T
Maximum Queue (ft)	194	229	197	195	128	151	168	181	150	152	151	127
Average Queue (ft)	120	105	65	81	52	78	76	69	69	81	91	57
95th Queue (ft)	189	202	152	154	113	133	146	142	127	132	136	112
Link Distance (ft)		196	196	196		879	879	879		410	410	410
Upstream Blk Time (%)	0	1	0	1								
Queuing Penalty (veh)	0	4	1	2								
Storage Bay Dist (ft)	200				450				260			
Storage Blk Time (%)	0	1										
Queuing Penalty (veh)	1	2										

Intersection: 3: Old Columbia Pike & National Drive

Movement	EB	EB	WB	WB	NB	NB	NB	NB	NB	SB	SB	SB	
Directions Served	LT	R	L	TR	L	T	T	T	R	L	T	T	
Maximum Queue (ft)	84	93	149	19	129	24	20	52	54	30	71	67	
Average Queue (ft)	34	45	71	1	57	2	1	9	13	7	32	23	
95th Queue (ft)	72	79	125	9	111	12	12	34	40	27	68	57	
Link Distance (ft)	443	443	414	414		410	410	410	410		884	884	
Upstream Blk Time (%)													
Queuing Penalty (veh)													
Storage Bay Dist (ft)					160					400			
Storage Blk Time (%)	0												
Queuing Penalty (veh)	0												

Intersection: 3: Old Columbia Pike & National Drive

Movement	SB	SB
Directions Served	T	R
Maximum Queue (ft)	128	45
Average Queue (ft)	52	14
95th Queue (ft)	105	39
Link Distance (ft)	884	
Upstream Blk Time (%)		
Queuing Penalty (veh)		
Storage Bay Dist (ft)	400	
Storage Blk Time (%)		
Queuing Penalty (veh)		

Intersection: 4: Old Columbia Pike & MD 198

Movement	EB	EB	EB	WB	WB	WB	NB	NB	NB	SB	SB	
Directions Served	L	T	TR	L	T	TR	L	T	R	L	TR	
Maximum Queue (ft)	82	312	311	175	320	298	174	101	72	38	21	
Average Queue (ft)	10	159	166	135	192	196	84	5	18	8	3	
95th Queue (ft)	44	266	270	213	303	287	156	45	61	27	14	
Link Distance (ft)		3434	3434		1102	1102		568			333	
Upstream Blk Time (%)												
Queuing Penalty (veh)												
Storage Bay Dist (ft)	100				150				160	50	75	
Storage Blk Time (%)			16	6	16	1	0	3				
Queuing Penalty (veh)			2	29	44	3	0	3				

Intersection: 5: Blackburn Road & US 29 SB Off Ramp

Movement	SB
Directions Served	LR
Maximum Queue (ft)	58
Average Queue (ft)	28
95th Queue (ft)	52
Link Distance (ft)	310
Upstream Blk Time (%)	
Queuing Penalty (veh)	
Storage Bay Dist (ft)	
Storage Blk Time (%)	
Queuing Penalty (veh)	

Intersection: 6: Lions Den Drive/Burtonsville Drive & MD 198

Movement	WB	WB	NB	SB
Directions Served	L	TR	LTR	LTR
Maximum Queue (ft)	28	710	107	51
Average Queue (ft)	2	24	36	15
95th Queue (ft)	15	501	85	43
Link Distance (ft)		3434	531	564
Upstream Blk Time (%)		0		
Queuing Penalty (veh)		0		
Storage Bay Dist (ft)	140			
Storage Blk Time (%)				
Queuing Penalty (veh)				

Intersection: 7: Old Columbia Pike & Greencastle Road

Movement	EB	WB	NB	NB	SB
Directions Served	LTR	LTR	LT	R	LTR
Maximum Queue (ft)	43	184	135	64	196
Average Queue (ft)	16	72	48	27	87
95th Queue (ft)	42	137	104	54	157
Link Distance (ft)	592	678	1027		686
Upstream Blk Time (%)					
Queuing Penalty (veh)					
Storage Bay Dist (ft)				500	
Storage Blk Time (%)					
Queuing Penalty (veh)					

Intersection: 8: Site Access/Shopping Center & MD 198

Movement	EB	EB	EB	WB	WB	WB	WB	NB	NB	SB	SB
Directions Served	L	T	TR	L	T	T	R	LT	R	LT	R
Maximum Queue (ft)	152	289	234	134	159	169	4	137	52	58	102
Average Queue (ft)	68	124	129	62	68	75	0	52	18	15	41
95th Queue (ft)	140	219	206	122	136	144	3	105	45	45	77
Link Distance (ft)		1102	1102		159	159	159	234	234	276	276
Upstream Blk Time (%)				0	0	1					
Queuing Penalty (veh)				0	2	3					
Storage Bay Dist (ft)	150			140							
Storage Blk Time (%)	1	7		1	1						
Queuing Penalty (veh)	4	7		4	1						

Intersection: 9: Site Access & MD 198

Movement	EB	EB	EB	WB	WB	WB	NB
Directions Served	T	T	TR	T	T	T	R
Maximum Queue (ft)	86	74	27	189	206	152	82
Average Queue (ft)	9	4	1	20	30	8	19
95th Queue (ft)	60	42	12	106	131	62	62
Link Distance (ft)	159	159	159	196	196	196	150
Upstream Blk Time (%)	0	0		0	0	0	0
Queuing Penalty (veh)	0	0		0	1	0	0
Storage Bay Dist (ft)							
Storage Blk Time (%)							
Queuing Penalty (veh)							

Network Summary

Network wide Queuing Penalty: 115

Intersection: 1: US 29 NB Off Ramp/US 29 NB On Ramp & MD 198

Movement	EB	EB	EB	EB	EB	WB	WB	WB	WB	NB	NB
Directions Served	L	L	T	T	T	T	T	T	R	L	LT
Maximum Queue (ft)	144	141	116	134	148	216	264	277	221	135	181
Average Queue (ft)	61	71	37	51	65	138	179	156	116	52	89
95th Queue (ft)	118	124	86	107	135	217	252	249	204	110	152
Link Distance (ft)			879	879	879	804	804	804	804	430	430
Upstream Blk Time (%)											
Queuing Penalty (veh)											
Storage Bay Dist (ft)	475	475									
Storage Blk Time (%)											
Queuing Penalty (veh)											

Intersection: 2: Old Columbia Pike & MD 198

Movement	EB	EB	EB	EB	EB	WB	WB	WB	WB	SB	SB	SB
Directions Served	L	T	T	T	R	L	L	T	T	L	L	LT
Maximum Queue (ft)	177	246	186	182	63	149	166	350	347	163	183	202
Average Queue (ft)	170	206	99	92	4	81	101	244	233	105	119	134
95th Queue (ft)	185	242	178	170	32	136	154	334	327	158	172	182
Link Distance (ft)		178	178	178	178		879	879	879		410	410
Upstream Blk Time (%)	36	62	1	1								
Queuing Penalty (veh)	0	195	3	4								
Storage Bay Dist (ft)	200					450				260		
Storage Blk Time (%)	36	62										
Queuing Penalty (veh)	94	194										

Intersection: 2: Old Columbia Pike & MD 198

Movement	SB
Directions Served	T
Maximum Queue (ft)	180
Average Queue (ft)	104
95th Queue (ft)	166
Link Distance (ft)	410
Upstream Blk Time (%)	
Queuing Penalty (veh)	
Storage Bay Dist (ft)	
Storage Blk Time (%)	
Queuing Penalty (veh)	

Intersection: 3: Old Columbia Pike & National Drive

Movement	EB	EB	WB	WB	NB	NB	NB	NB	NB	SB	SB	SB
Directions Served	LT	R	L	TR	L	T	T	T	R	L	T	T
Maximum Queue (ft)	104	235	442	364	185	311	154	93	154	35	140	130
Average Queue (ft)	38	106	327	159	127	77	37	30	44	5	74	58
95th Queue (ft)	80	187	517	473	206	267	108	71	104	25	121	103
Link Distance (ft)	443	443	414	414		410	410	410	410		884	884
Upstream Blk Time (%)			34	16		0						
Queuing Penalty (veh)			0	0		0						
Storage Bay Dist (ft)					160					400		
Storage Blk Time (%)					20	1						
Queuing Penalty (veh)					16	1						

Intersection: 3: Old Columbia Pike & National Drive

Movement	SB	SB
Directions Served	T	R
Maximum Queue (ft)	219	67
Average Queue (ft)	110	29
95th Queue (ft)	191	58
Link Distance (ft)	884	
Upstream Blk Time (%)		
Queuing Penalty (veh)		
Storage Bay Dist (ft)		400
Storage Blk Time (%)		
Queuing Penalty (veh)		

Intersection: 4: Old Columbia Pike & MD 198

Movement	EB	EB	EB	WB	WB	WB	NB	NB	NB	SB	SB
Directions Served	L	T	TR	L	T	TR	L	T	R	L	TR
Maximum Queue (ft)	124	380	388	175	793	768	152	193	75	73	66
Average Queue (ft)	16	255	247	170	471	418	55	30	41	22	15
95th Queue (ft)	71	355	360	197	885	853	118	119	91	58	47
Link Distance (ft)		3434	3434		1102	1102		568			333
Upstream Blk Time (%)					0	0					
Queuing Penalty (veh)					1	1					
Storage Bay Dist (ft)	100			150			160		50	75	
Storage Blk Time (%)		35		57	17		0	1	11	2	0
Queuing Penalty (veh)		5		284	78		0	2	10	1	0

Intersection: 5: Blackburn Road & US 29 SB Off Ramp

Movement	SB
Directions Served	LR
Maximum Queue (ft)	81
Average Queue (ft)	46
95th Queue (ft)	71
Link Distance (ft)	310
Upstream Blk Time (%)	
Queuing Penalty (veh)	
Storage Bay Dist (ft)	
Storage Blk Time (%)	
Queuing Penalty (veh)	

Intersection: 6: Lions Den Drive/Burtonsville Drive & MD 198

Movement	EB	WB	NB	SB
Directions Served	L	L	LTR	LTR
Maximum Queue (ft)	5	40	70	30
Average Queue (ft)	0	12	22	2
95th Queue (ft)	4	35	61	15
Link Distance (ft)			531	564
Upstream Blk Time (%)				
Queuing Penalty (veh)				
Storage Bay Dist (ft)	240	140		
Storage Blk Time (%)				
Queuing Penalty (veh)				

Intersection: 7: Old Columbia Pike & Greencastle Road

Movement	EB	WB	NB	NB	SB
Directions Served	LTR	LTR	LT	R	LTR
Maximum Queue (ft)	52	97	119	42	349
Average Queue (ft)	17	39	42	15	164
95th Queue (ft)	44	75	90	40	293
Link Distance (ft)	592	678	1027		686
Upstream Blk Time (%)					
Queuing Penalty (veh)					
Storage Bay Dist (ft)				500	
Storage Blk Time (%)					
Queuing Penalty (veh)					

Intersection: 8: Site Access/Shopping Center & MD 198

Movement	EB	EB	EB	WB	WB	WB	WB	NB	SB	SB
Directions Served	L	T	TR	L	T	T	R	LTR	LT	R
Maximum Queue (ft)	175	883	898	54	29	20	3	130	268	234
Average Queue (ft)	116	339	293	13	1	1	0	38	168	122
95th Queue (ft)	211	928	901	37	15	9	2	108	312	276
Link Distance (ft)		1102	1102		172	172	172	238	276	276
Upstream Blk Time (%)		1	1					0	22	23
Queuing Penalty (veh)		8	7					0	0	0
Storage Bay Dist (ft)	150			140						
Storage Blk Time (%)	4	30								
Queuing Penalty (veh)	25	50								

Intersection: 9: Site Access & MD 198

Movement	EB	EB	EB	WB	WB	WB	NB
Directions Served	T	T	TR	T	T	T	R
Maximum Queue (ft)	206	194	143	193	220	233	143
Average Queue (ft)	164	55	13	29	42	26	119
95th Queue (ft)	240	168	76	126	159	131	166
Link Distance (ft)	172	172	172	178	178	178	130
Upstream Blk Time (%)	39	0	0	0	1	0	85
Queuing Penalty (veh)	152	2	0	1	3	2	0
Storage Bay Dist (ft)							
Storage Blk Time (%)							
Queuing Penalty (veh)							

Network Summary

Network wide Queuing Penalty: 1136

Intersection: 1: US 29 NB Off Ramp/US 29 NB On Ramp & MD 198

Movement	EB	EB	EB	EB	EB	WB	WB	WB	WB	NB	NB
Directions Served	L	L	T	T	T	T	T	T	R	L	LT
Maximum Queue (ft)	143	155	182	191	231	302	346	333	263	105	152
Average Queue (ft)	87	102	108	129	155	199	231	200	117	33	79
95th Queue (ft)	135	152	163	179	208	283	320	292	211	76	143
Link Distance (ft)			879	879	879	804	804	804	804	432	432
Upstream Blk Time (%)											
Queuing Penalty (veh)											
Storage Bay Dist (ft)	475	475									
Storage Blk Time (%)											
Queuing Penalty (veh)											

Intersection: 2: Old Columbia Pike & MD 198

Movement	EB	EB	EB	EB	WB	WB	WB	WB	WB	SB	SB	SB
Directions Served	L	T	T	TR	L	L	T	T	R	L	L	LT
Maximum Queue (ft)	196	254	216	240	130	146	526	603	380	149	180	190
Average Queue (ft)	171	195	140	154	65	83	266	267	35	94	112	130
95th Queue (ft)	226	273	218	243	116	127	464	477	238	140	160	172
Link Distance (ft)		196	196	196		879	879	879			410	410
Upstream Blk Time (%)	6	10	1	3				0				
Queuing Penalty (veh)	0	41	5	14				0				
Storage Bay Dist (ft)	200				450				450	260		
Storage Blk Time (%)	6	10						1	0			
Queuing Penalty (veh)	15	30						3	0			

Intersection: 2: Old Columbia Pike & MD 198

Movement	SB	SB
Directions Served	T	R
Maximum Queue (ft)	160	40
Average Queue (ft)	98	1
95th Queue (ft)	151	28
Link Distance (ft)	410	410
Upstream Blk Time (%)		
Queuing Penalty (veh)		
Storage Bay Dist (ft)		
Storage Blk Time (%)		
Queuing Penalty (veh)		

Intersection: 3: Old Columbia Pike & National Drive

Movement	EB	EB	WB	WB	NB	NB	NB	NB	NB	SB	SB	SB
Directions Served	LT	R	L	TR	L	T	T	T	R	L	T	T
Maximum Queue (ft)	101	214	434	334	184	183	76	68	126	34	132	120
Average Queue (ft)	41	91	297	66	117	24	20	27	41	7	72	59
95th Queue (ft)	82	163	471	282	193	113	61	60	90	27	118	105
Link Distance (ft)	443	443	414	414		410	410	410	410		884	884
Upstream Blk Time (%)			14	4								
Queuing Penalty (veh)			0	0								
Storage Bay Dist (ft)					160					400		
Storage Blk Time (%)					12							
Queuing Penalty (veh)					9							

Intersection: 3: Old Columbia Pike & National Drive

Movement	SB	SB
Directions Served	T	R
Maximum Queue (ft)	210	77
Average Queue (ft)	108	25
95th Queue (ft)	177	55
Link Distance (ft)	884	
Upstream Blk Time (%)		
Queuing Penalty (veh)		
Storage Bay Dist (ft)		400
Storage Blk Time (%)		
Queuing Penalty (veh)		

Intersection: 4: Old Columbia Pike & MD 198

Movement	EB	EB	EB	WB	WB	WB	NB	NB	NB	SB	SB
Directions Served	L	T	TR	L	T	TR	L	T	R	L	TR
Maximum Queue (ft)	85	368	368	175	844	833	140	185	76	74	50
Average Queue (ft)	12	236	235	173	479	461	53	25	40	23	13
95th Queue (ft)	53	348	344	185	849	844	113	111	89	57	38
Link Distance (ft)		3434	3434		1102	1102		568			333
Upstream Blk Time (%)											
Queuing Penalty (veh)											
Storage Bay Dist (ft)	100			150			160		50	75	
Storage Blk Time (%)		30		43	36		0	0	9	1	
Queuing Penalty (veh)		4		215	165		0	1	8	0	

Intersection: 5: Blackburn Road & US 29 SB Off Ramp

Movement	SB
Directions Served	LR
Maximum Queue (ft)	101
Average Queue (ft)	44
95th Queue (ft)	74
Link Distance (ft)	310
Upstream Blk Time (%)	
Queuing Penalty (veh)	
Storage Bay Dist (ft)	
Storage Blk Time (%)	
Queuing Penalty (veh)	

Intersection: 6: Lions Den Drive/Burtonsville Drive & MD 198

Movement	WB	NB	SB
Directions Served	L	LTR	LTR
Maximum Queue (ft)	41	43	30
Average Queue (ft)	14	15	3
95th Queue (ft)	40	41	17
Link Distance (ft)		531	564
Upstream Blk Time (%)			
Queuing Penalty (veh)			
Storage Bay Dist (ft)	140		
Storage Blk Time (%)			
Queuing Penalty (veh)			

Intersection: 7: Old Columbia Pike & Greencastle Road

Movement	EB	WB	NB	NB	SB
Directions Served	LTR	LTR	LT	R	LTR
Maximum Queue (ft)	57	106	119	50	461
Average Queue (ft)	19	41	46	17	179
95th Queue (ft)	49	80	93	42	363
Link Distance (ft)	592	678	1027		686
Upstream Blk Time (%)					0
Queuing Penalty (veh)					0
Storage Bay Dist (ft)				500	
Storage Blk Time (%)					
Queuing Penalty (veh)					

Intersection: 8: Site Access/Shopping Center & MD 198

Movement	EB	EB	EB	WB	WB	WB	WB	NB	NB	SB	SB
Directions Served	L	T	TR	L	T	T	R	LT	R	LT	R
Maximum Queue (ft)	175	513	464	127	175	175	32	90	58	104	155
Average Queue (ft)	113	197	183	38	132	136	4	37	13	32	74
95th Queue (ft)	199	407	369	90	191	198	18	81	41	74	136
Link Distance (ft)		1102	1102		159	159	159	234	234	276	276
Upstream Blk Time (%)				0	7	8					
Queuing Penalty (veh)				0	31	39					
Storage Bay Dist (ft)	150			140							
Storage Blk Time (%)	5	8		0	11						
Queuing Penalty (veh)	26	13		2	11						

Intersection: 9: Site Access & MD 198

Movement	EB	EB	EB	WB	WB	WB	NB
Directions Served	T	T	TR	T	T	T	R
Maximum Queue (ft)	184	164	72	219	244	240	88
Average Queue (ft)	70	16	6	52	77	34	18
95th Queue (ft)	179	88	45	175	221	160	63
Link Distance (ft)	159	159	159	196	196	196	150
Upstream Blk Time (%)	2	0	0	0	1	0	0
Queuing Penalty (veh)	7	1	0	1	5	2	0
Storage Bay Dist (ft)							
Storage Blk Time (%)							
Queuing Penalty (veh)							

Network Summary

Network wide Queuing Penalty: 650

Appendix C

Background Developments

Trip Generation Rates

Shopping Plaza w/ Supermarket (40-150ksf) (ksf, ITE-821)

Morning Trips = 3.53 x ksf
 Evening Trips = 7.67 x ksf + 118.86

Drive-in Bank (ksf, ITE-912)

Morning Trips = 9.95 x ksf
 Evening Trips = 21.01 x ksf

Fast Casual Restaurant (ksf, ITE-930)

Morning Trips = 1.43 x ksf
 Evening Trips = 12.55 x ksf

Trip Distribution (In/Out)

62/38

48/52

Trip Distribution (In/Out)

58/42

50/50

Trip Distribution (In/Out)

50/50

55/45

ITE Vehicular Trip Generation Totals

		AM Peak			PM Peak		
		In	Out	Total	In	Out	Total
Existing	Shopping Plaza w/ Supermarket (40-150ksf) (ksf, ITE-821)	283	173	456	532	577	1109

		AM Peak			PM Peak		
		In	Out	Total	In	Out	Total
Existing	Existing Vehicular Trips per ITE Trip Generation Manual, 11th Edition:	283	173	456	532	577	1109
	LATR Vehicle Trip Generation Rate Adjustment Factor (Burtonsville Town Center): 99%						
	Total LATR Adjusted Vehicular Trips per ITE Trip Generation Manual, 11th Edition (Auto Driver at 71.6%):	280	171	451	527	571	1098
	Total Person Trips:	391	239	630	737	797	1534
	Auto Driver: 71.6%	280	171	451	527	571	1098
Auto Passenger: 24.3%	95	58	153	179	194	373	
Transit: 1.0%	4	2	6	7	8	15	
Non-Motorized: 3.1%	12	8	20	24	24	48	

	AM Peak			PM Peak		
	In	Out	Total	In	Out	Total
Existing Vehicular Trips:	280	171	451	527	571	1098
Pass-by Trips (0% AM/40% PM):	0	0	0	-211	-228	-439
Primary Trips:	280	171	451	316	343	659

NOTE: The currently vacant portion of the existing shopping center is considered a background development for the purposes of the vehicular portion of the LATR. To provide a conservative analysis, the entire existing shopping center is considered vacant.

Transportation Impact Study	Proposed Trip Generation for Site	Exhibit C-1
 LENHART TRAFFIC CONSULTING, INC. 645 BALTIMORE ANNAPOLIS BLVD, SUITE 214 SEVERNA PARK, MD 21146 www.lenharttraffic.com		

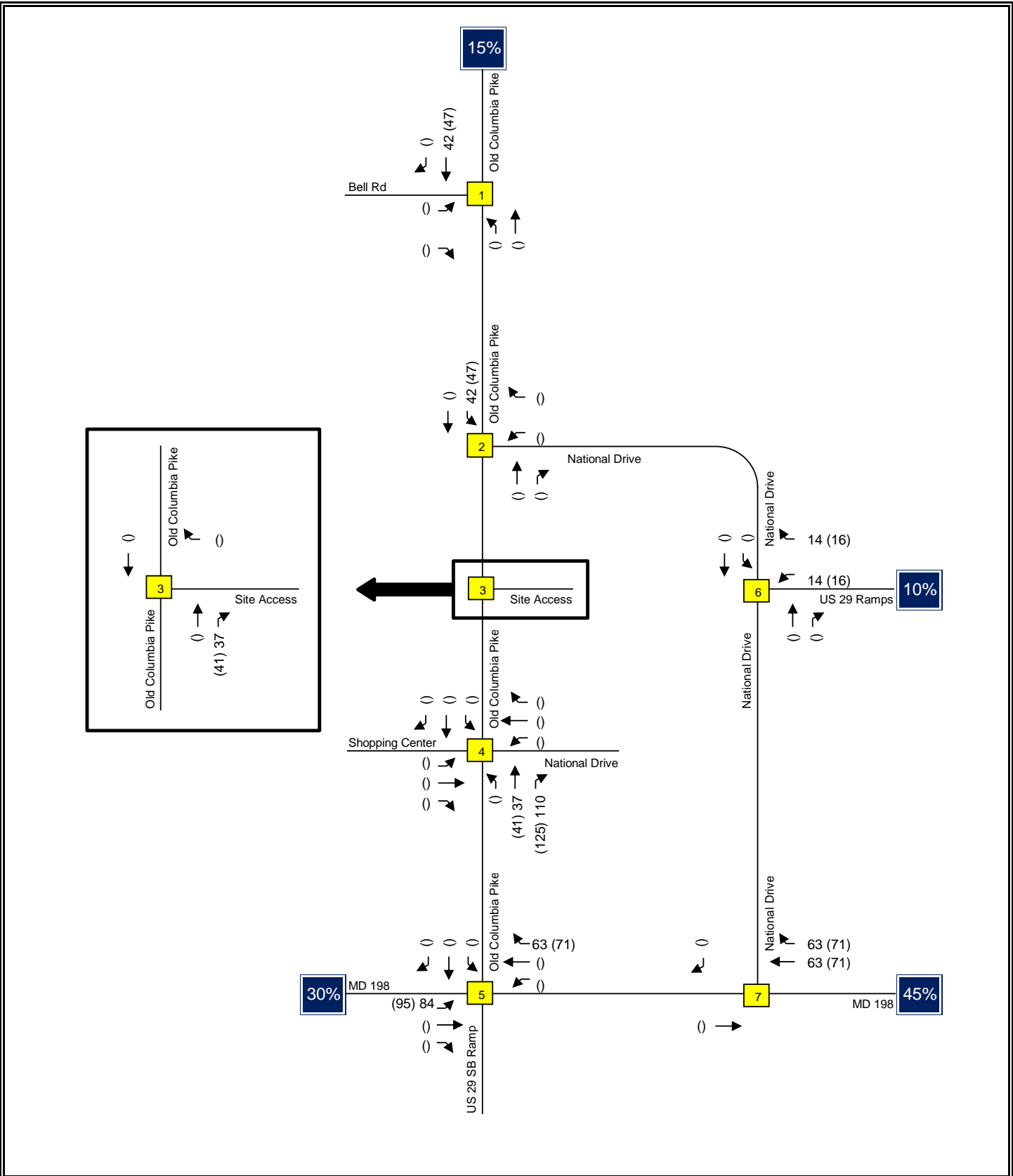

Transportation Impact Analysis



Inbound Trip Assignment for Vacant Shopping Center

Key: xx = AM Peak Vol's (xx) = PM Peak Vol's

Exhibit C-2a

Outbound Trip Assumptions

Trips North along Old Columbia Pike:
 50% Exits at Intersection 2
 50% Exits at Intersection 3

Trips South along Old Columbia Pike:
 25% Exits at Intersection 2
 75% Exits at Intersection 4

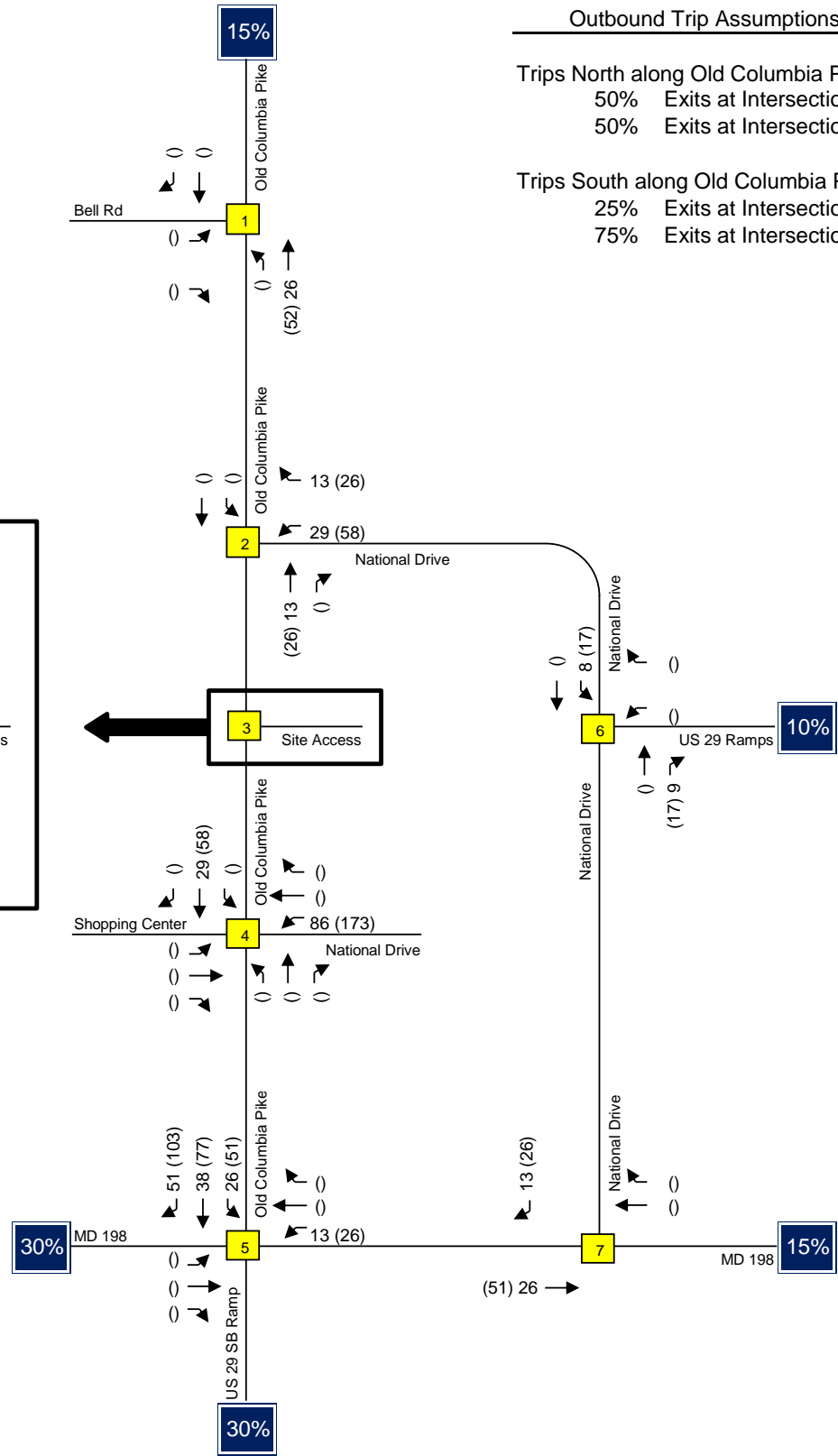
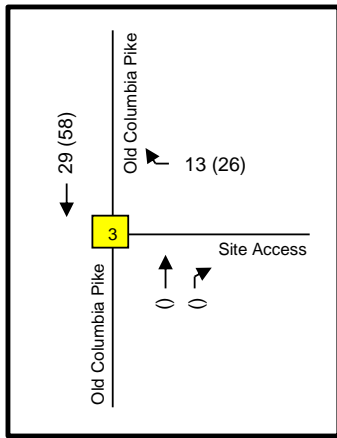

Transportation Impact Analysis

Outbound Trip Assignment for Vacant Shopping Center

Exhibit C-2b

LENHART TRAFFIC CONSULTING, INC.
 645 BALTIMORE ANNAPOLIS BLVD, SUITE 214
 SEVERNA PARK, MD 21146
 www.lenharttraffic.com

Key: xx = AM Peak Vol's (xx) = PM Peak Vol's

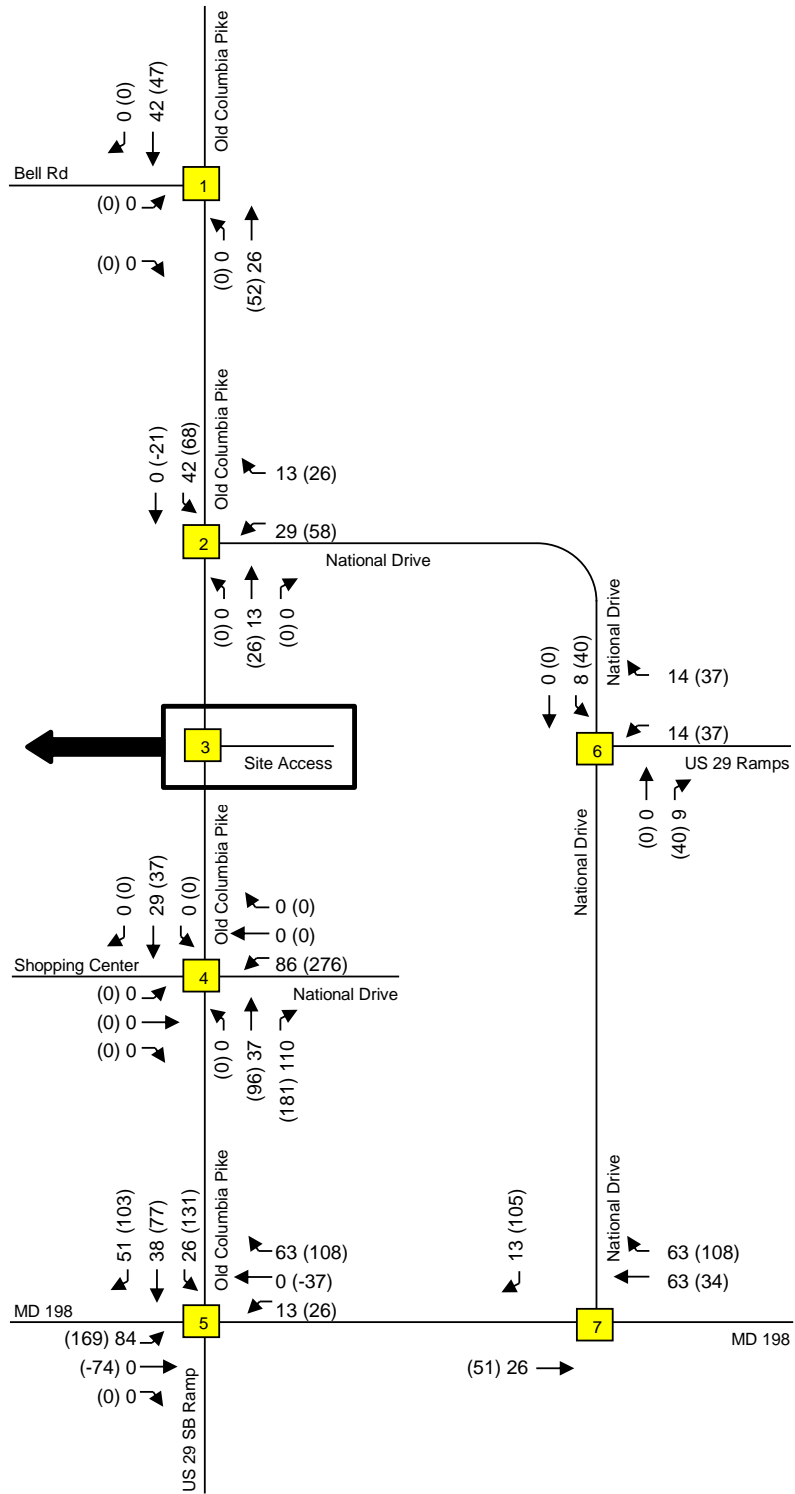
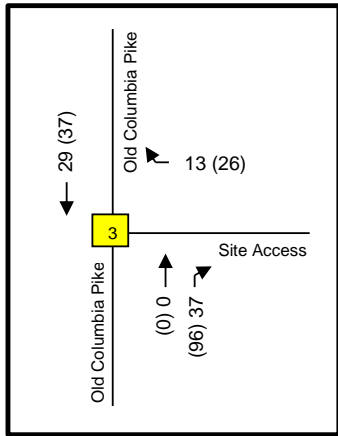

Transportation Impact Analysis



Combined Trip Assignment for Vacant Shopping Center

Key: xx = AM Peak Vol's (xx) = PM Peak Vol's

Exhibit C-3

Trip Generation Rates

Shopping Plaza w/ Supermarket (40-150ksf) (ksf, ITE-821)	<u>Trip Distribution (In/Out)</u>
Morning Trips = 3.53 x ksf	62/38
Evening Trips = 7.67 x ksf + 118.86	48/52
Drive-in Bank (ksf, ITE-912)	<u>Trip Distribution (In/Out)</u>
Morning Trips = 9.95 x ksf	58/42
Evening Trips = 21.01 x ksf	50/50
Fast Casual Restaurant (ksf, ITE-930)	<u>Trip Distribution (In/Out)</u>
Morning Trips = 1.43 x ksf	50/50
Evening Trips = 12.55 x ksf	55/45

ITE Vehicular Trip Generation Totals

		AM Peak			PM Peak				
		In	Out	Total	In	Out	Total		
Existing	Shopping Plaza w/ Supermarket (40-150ksf) (ksf, ITE-821)	129,140	sq.ft.	283	173	456	532	577	1109
	Shopping Plaza w/ Supermarket (40-150ksf) (ksf, ITE-821)	121,983	sq.ft.	267	164	431	506	548	1054
Proposed:	Drive-in Bank (ksf, ITE-912)	3,500	sq.ft.	20	15	35	37	37	74
	Fast Casual Restaurant (ksf, ITE-930)	4,500	sq.ft.	3	3	6	31	25	56

Existing	Existing Vehicular Trips per ITE Trip Generation Manual, 11th Edition: LATR Vehicle Trip Generation Rate Adjustment Factor (Burtonsville Town Center): 99% Total LATR Adjusted Vehicular Trips per ITE Trip Generation Manual, 11th Edition (Auto Driver at 71.6%):	<table border="1" style="width: 100%; border-collapse: collapse; text-align: center;"> <thead> <tr> <th colspan="3">AM Peak</th> <th colspan="3">PM Peak</th> </tr> <tr> <th>In</th> <th>Out</th> <th>Total</th> <th>In</th> <th>Out</th> <th>Total</th> </tr> </thead> <tbody> <tr> <td>283</td> <td>173</td> <td>456</td> <td>532</td> <td>577</td> <td>1109</td> </tr> <tr> <td>280</td> <td>171</td> <td>451</td> <td>527</td> <td>571</td> <td>1098</td> </tr> </tbody> </table>	AM Peak			PM Peak			In	Out	Total	In	Out	Total	283	173	456	532	577	1109	280	171	451	527	571	1098
AM Peak			PM Peak																							
In	Out	Total	In	Out	Total																					
283	173	456	532	577	1109																					
280	171	451	527	571	1098																					

Proposed	Proposed Vehicular Trips per ITE Trip Generation Manual, 11th Edition: LATR Vehicle Trip Generation Rate Adjustment Factor (Burtonsville Town Center): 99% Total LATR Adjusted Vehicular Trips per ITE Trip Generation Manual, 11th Edition (Auto Driver at 71.6%):	<table border="1" style="width: 100%; border-collapse: collapse; text-align: center;"> <thead> <tr> <th colspan="3">AM Peak</th> <th colspan="3">PM Peak</th> </tr> <tr> <th>In</th> <th>Out</th> <th>Total</th> <th>In</th> <th>Out</th> <th>Total</th> </tr> </thead> <tbody> <tr> <td>290</td> <td>182</td> <td>472</td> <td>574</td> <td>610</td> <td>1184</td> </tr> <tr> <td>287</td> <td>180</td> <td>467</td> <td>568</td> <td>604</td> <td>1172</td> </tr> </tbody> </table>	AM Peak			PM Peak			In	Out	Total	In	Out	Total	290	182	472	574	610	1184	287	180	467	568	604	1172
AM Peak			PM Peak																							
In	Out	Total	In	Out	Total																					
290	182	472	574	610	1184																					
287	180	467	568	604	1172																					

	AM Peak			PM Peak		
	In	Out	Total	In	Out	Total
Proposed Vehicular Trips	287	180	467	568	604	1172
Existing Vehicular Trips:	280	171	451	527	571	1098
Net New Vehicular Trips:	7	9	16	41	33	74
Net New Pass-by Trips (0% AM/40% PM):	0	0	0	-17	-13	-30
Net New Primary Trips:	7	9	16	24	20	44

- NOTES:** 1. Trip Generation based on ITE Trip Generation Manual, 11th Edition, rates, adjusted in accordance with LATR Guidelines
2. The ITE Trip Generation Manual includes pad sites such as the proposed bank and restaurant within the definition of a shopping plaza, Montgomery County Staff requested the bank and restaurant to be analyzed individually in addition to the retail space.
3. To provide a conservative estimation of the net new pass-by trips for the site, the pass-by rate for ITE-821 (Shopping Plaza) was applied to the net new vehicular trips for the proposed redevelopment, which includes the trips from the retail space, bank, and restaurant.

Transportation Impact Analysis



Proposed Vehicular
Trip Generation for
Proposed Burtonsville Crossing

Exhibit
C-4

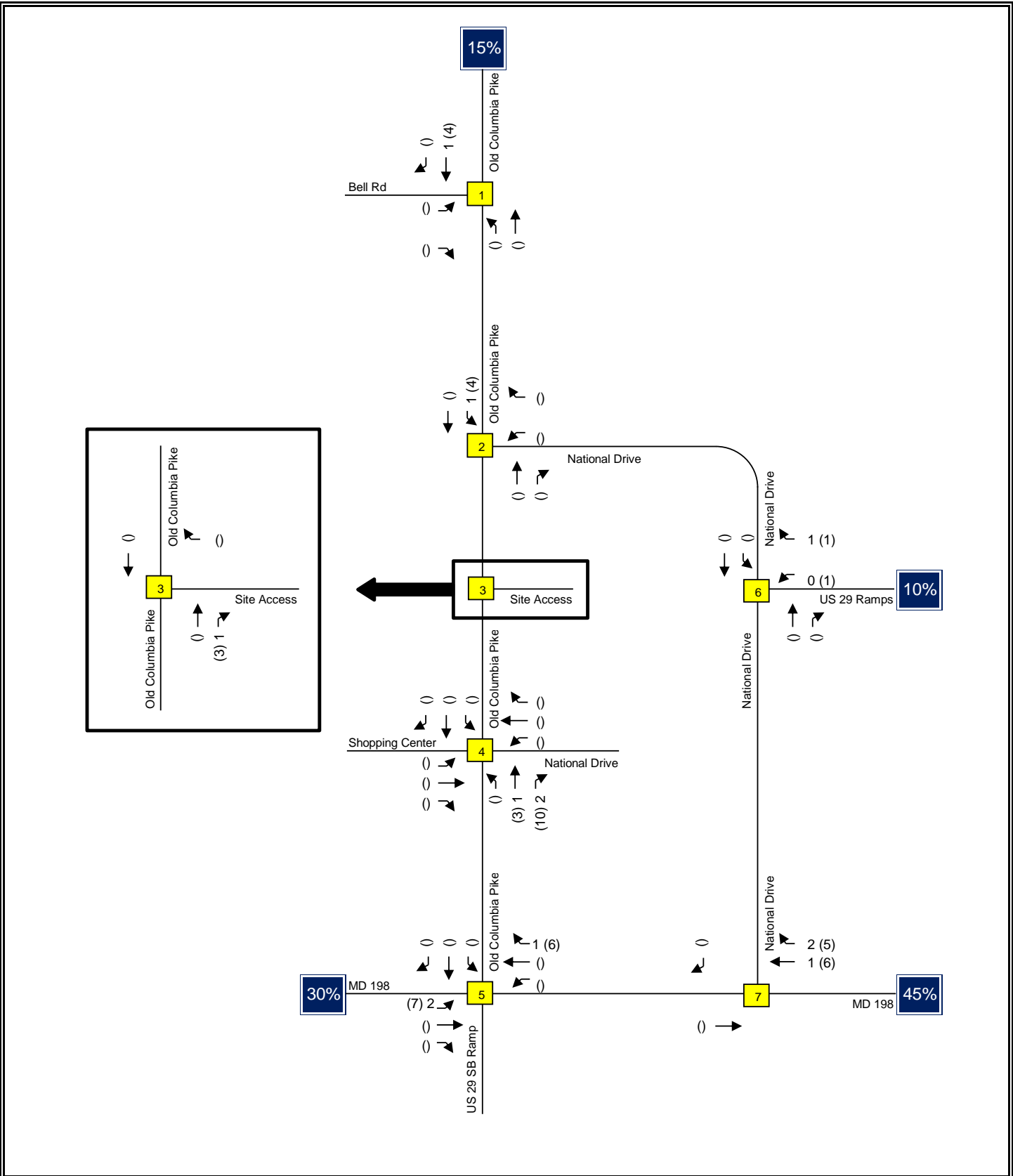

Transportation Impact Analysis

LENHART TRAFFIC CONSULTING, INC.
 645 BALTIMORE ANNAPOLIS BLVD, SUITE 214
 SEVERNA PARK, MD 21146
 www.lenharttraffic.com

**Inbound Trip Assignment
 for Prop. Burtonsville Crossing**

Key: xx = AM Peak Vol's (xx) = PM Peak Vol's

**Exhibit
 C-5a**

Pass-by Trip Assumptions
 20% along SB US 29
 10% along SB Old Columbia Pike
 35% along EB MD 193
 35% along WB MD 193

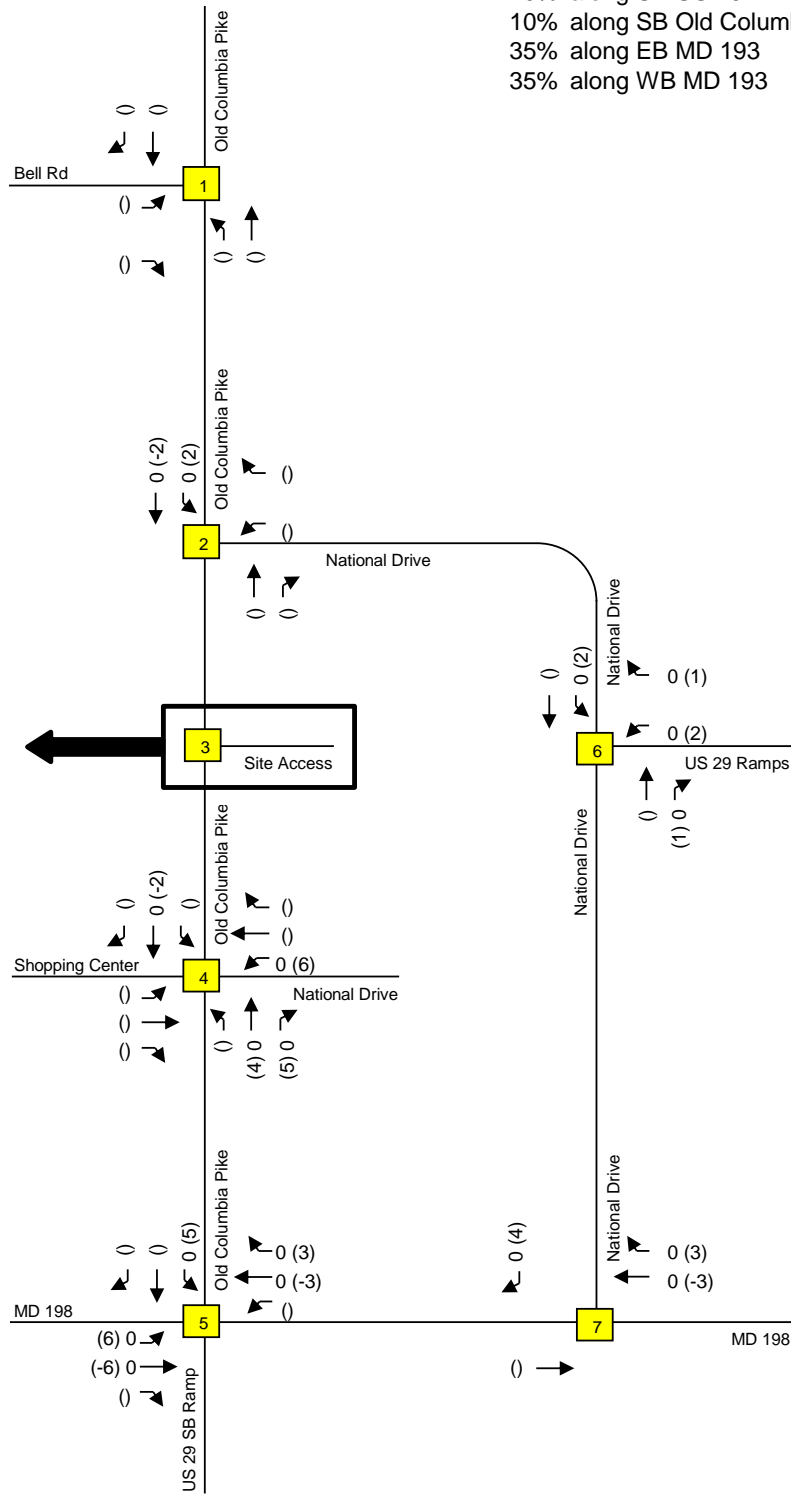
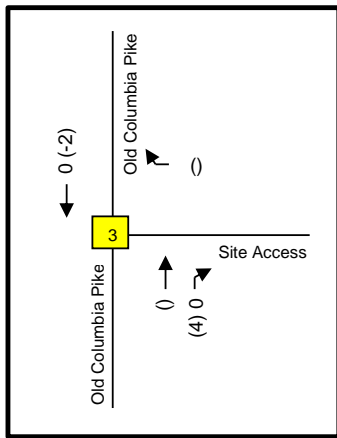

Transportation Impact Analysis



Pass-by Trip Assignment for Prop. Burtonsville Crossing

Key: xx = AM Peak Vol's (xx) = PM Peak Vol's

**Exhibit
6c**

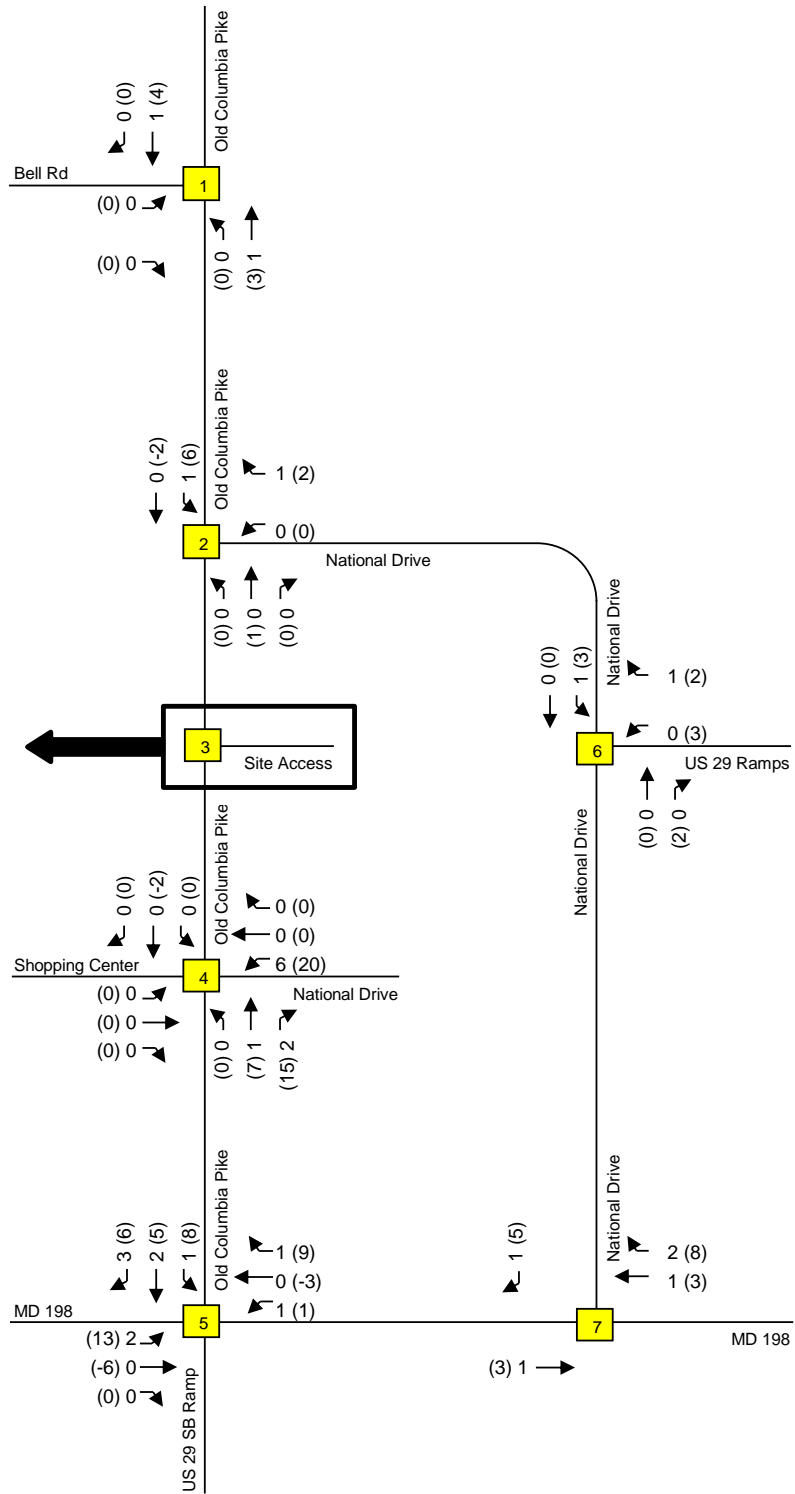
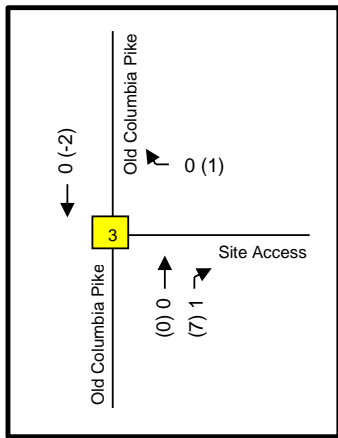

Transportation Impact Analysis

LENHART TRAFFIC CONSULTING, INC.
 645 BALTIMORE ANNAPOLIS BLVD, SUITE 214
 SEVERNA PARK, MD 21146
 www.lenharttraffic.com

Combined Trip Assignment
 for Prop. Burtonsville Crossing

Key: xx = AM Peak Vol's (xx) = PM Peak Vol's

Exhibit
 C-6

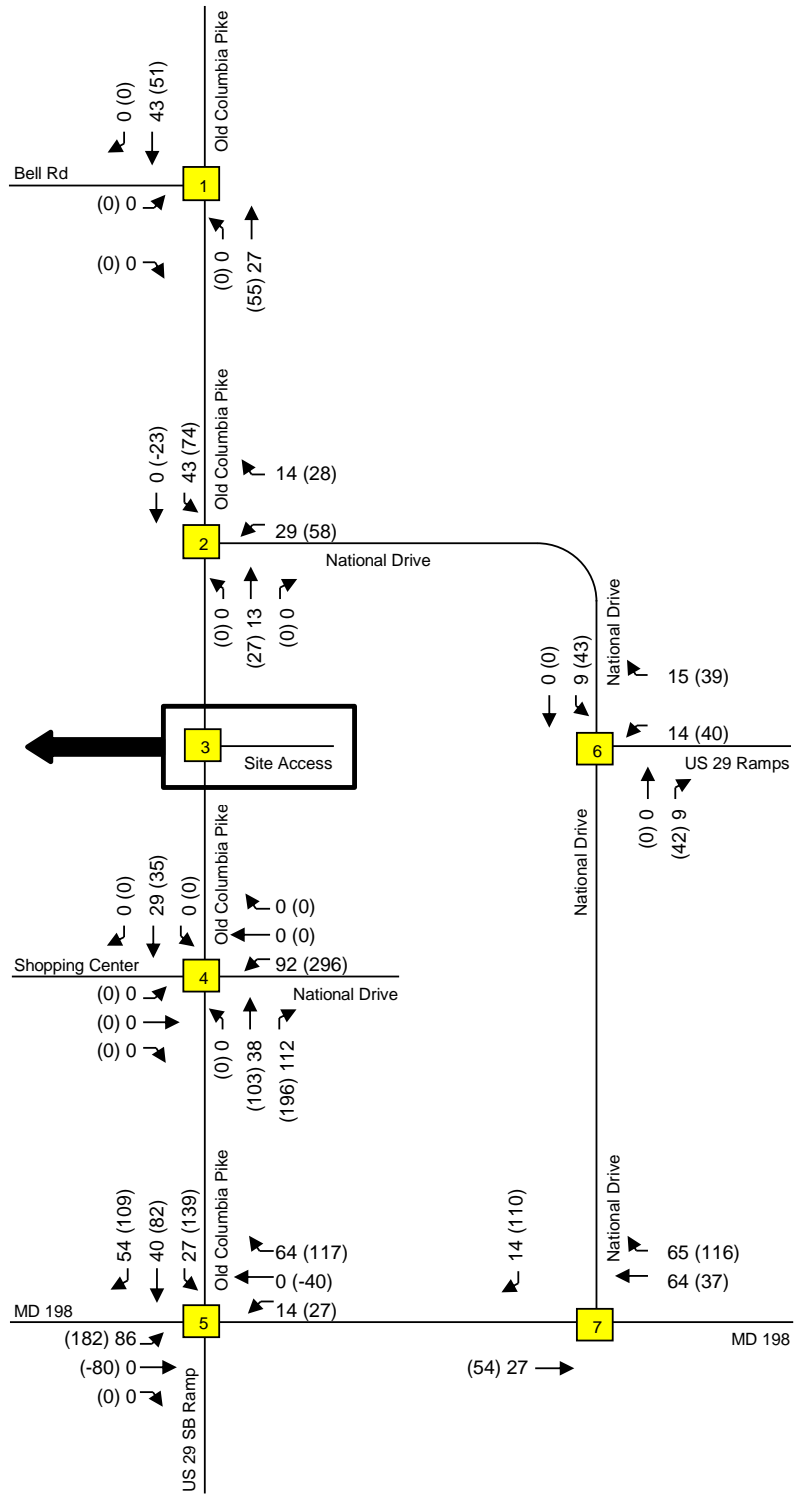
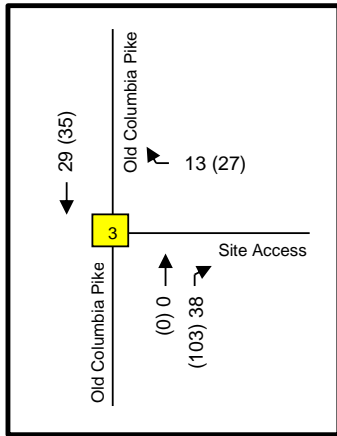

Transportation Impact Analysis



Combined Trip Assignment
 for Background Developments

Key: xx = AM Peak Vol's (xx) = PM Peak Vol's

Exhibit
 C-7

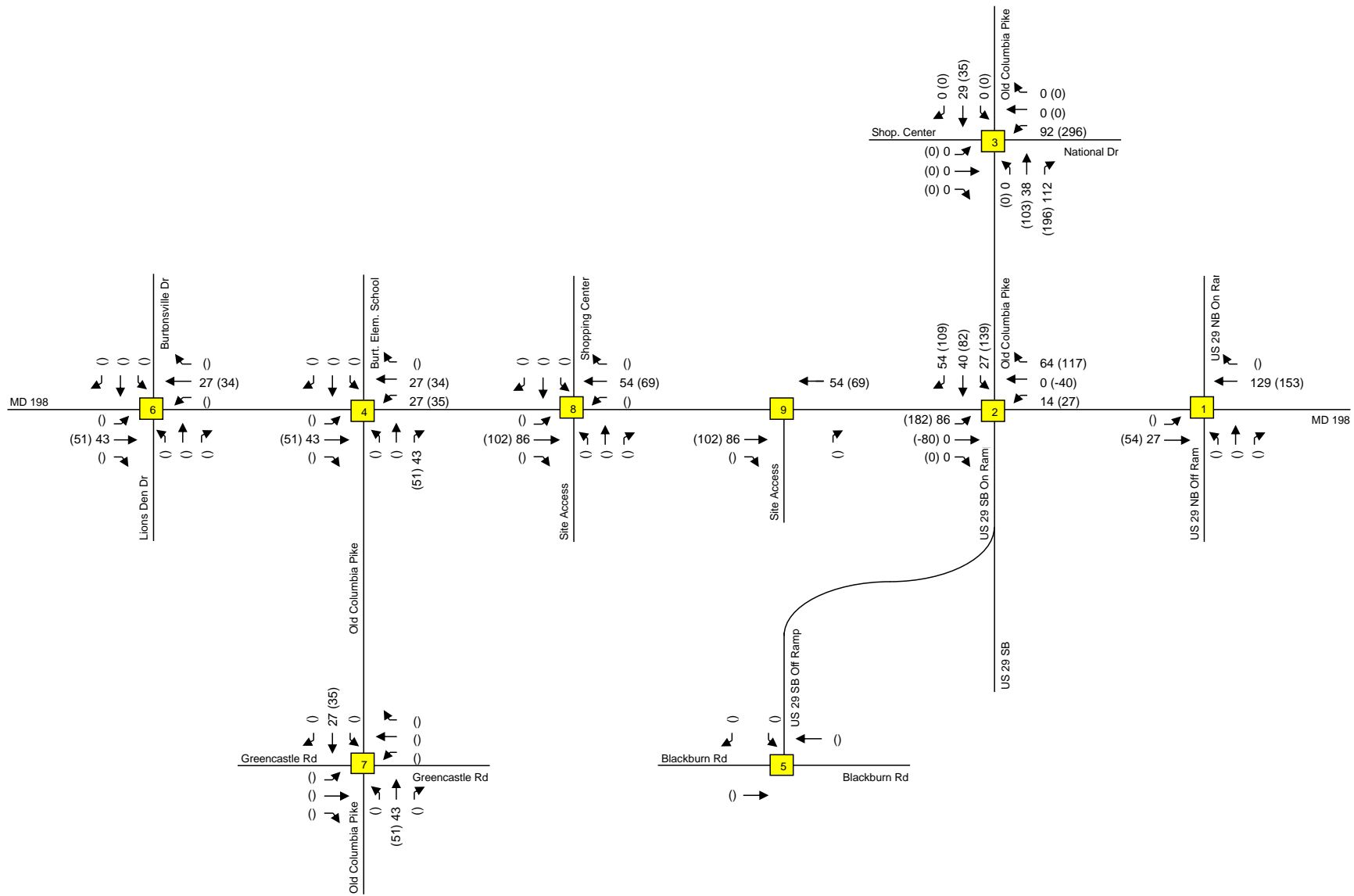

Traffic Impact Analysis

Lenhart Traffic Consulting, Inc.

Traffic Engineering & Transportation Planning

Combined Trip Assignment for Background Developments

Key: xx = AM Peak Vol's (xx) = PM Peak Vol's

**Exhibit
C-8**

Appendix D

Traffic Signal Warrnat Analysis
MD 198 & Site Access/Shopping Center

Table 4C-1. Warrant 1, Eight Hour Vehicular Volume

Condition A -- Minimum Vehicular Volume									
Number of lanes for moving traffic on each approach		Vehicles per hour on major street (total of both approaches)				Vehicles per hour on higher volume minor street approach (one direction only)			
<u>Major Street</u>	<u>Minor Street</u>	<u>100%^a</u>	<u>80%^b</u>	<u>70%^c</u>	<u>56%^d</u>	<u>100%^a</u>	<u>80%^b</u>	<u>70%^c</u>	<u>56%^d</u>
1	1	500	400	350	280	150	120	105	84
2 or more	1	600	480	420	336	150	120	105	84
2 or more	2 or more	600	480	420	336	200	160	140	112
1	2 or more	500	400	350	280	200	160	140	112

Condition B -- Interruption of Continuous Traffic									
Number of lanes for moving traffic on each approach		Vehicles per hour on major street (total of both approaches)				Vehicles per hour on higher volume minor street approach (one direction only)			
<u>Major Street</u>	<u>Minor Street</u>	<u>100%^a</u>	<u>80%^b</u>	<u>70%^c</u>	<u>56%^d</u>	<u>100%^a</u>	<u>80%^b</u>	<u>70%^c</u>	<u>56%^d</u>
1	1	750	600	525	420	75	60	53	42
2 or more	1	900	720	630	504	75	60	53	42
2 or more	2 or more	900	720	630	504	100	80	70	56
1	2 or more	750	600	525	420	100	80	70	56

Source: Manual on Uniform Traffic Control Devices (MUTCD) 2003 Edition

a Basic minimum hourly volume.

b Used for combination of Conditions A and B after adequate trial of other remedial measures.

c May be used when the major street speed exceeds 40 mph or in an isolated community with a population < 10,000.

d May be used in combination of Conditions A and B after adequate trial of other remedial measures when the major street exceeds 40 mph or in an isolated community with a population of < 10,000.

Traffic Signal Warrant Analysis	Description of Warrant 1 from MUTCD	Exhibit D-1
 LENHART TRAFFIC CONSULTING, INC. 645 BALTIMORE ANNAPOLIS BLVD, SUITE 214 SEVERNA PARK, MD 21146 www.lenharttraffic.com		

Intersection Turning Movement Count

Hour Beginning	7-Eleven Access			Shopping Ctr Access			Old Columbia Pike			Old Columbia Pike		
	Northbound			Southbound			Eastbound			Westbound		
	Left	Thru	Right	Left	Thru	Right	Left	Thru	Right	Left	Thru	Right
6:00 AM	1	0	4	10	0	33	45	551	51	79	686	22
7:00 AM	5	0	20	10	0	82	74	762	61	83	1164	50
8:00 AM	9	0	11	11	5	86	127	828	49	34	935	65
9:00 AM	11	1	10	13	2	103	138	711	51	45	692	77
10:00 AM	9	1	12	18	7	111	126	542	38	37	517	81
11:00 AM	9	0	16	20	4	143	152	554	49	50	532	128
12:00 PM	9	3	18	31	7	167	163	639	53	48	588	156
1:00 PM	9	2	18	24	3	165	141	630	43	46	628	130
2:00 PM	6	6	17	27	12	156	137	694	47	48	772	106
3:00 PM	7	1	17	17	5	158	160	961	41	54	902	123
4:00 PM	7	2	15	34	6	177	167	1009	47	51	1042	140
5:00 PM	6	1	13	25	9	180	164	1014	47	52	1161	127
6:00 PM	6	4	15	29	8	205	162	864	50	38	898	130

Lenhart Traffic Consulting, Inc.

Traffic Engineering & Transportation Planning

Existing Turning Movement Counts

Exhibit

D-2

Intersection Turning Movement Count

Hour Beginning	7-Eleven Access			Shopping Ctr Access			Old Columbia Pike			Old Columbia Pike		
	Northbound			Southbound			Eastbound			Westbound		
	Left	Thru	Right	Left	Thru	Right	Left	Thru	Right	Left	Thru	Right
6:00 AM	1	0	4	10	0	33	45	551	51	79	686	22
7:00 AM	5	0	20	10	0	82	74	762	61	83	1164	50
8:00 AM	9	0	11	11	5	86	127	828	49	34	935	65
9:00 AM	11	1	10	13	2	103	138	711	51	45	692	77
10:00 AM	9	1	12	18	7	111	126	542	38	37	517	81
11:00 AM	9	0	16	20	4	143	152	554	49	50	532	128
12:00 PM	9	3	18	31	7	167	163	639	53	48	588	156
1:00 PM	9	2	18	24	3	165	141	630	43	46	628	130
2:00 PM	6	6	17	27	12	156	137	694	47	48	772	106
3:00 PM	7	1	17	17	5	158	160	961	41	54	902	123
4:00 PM	7	2	15	34	6	177	167	1009	47	51	1042	140
5:00 PM	6	1	13	25	9	180	164	1014	47	52	1161	127
6:00 PM	6	4	15	29	8	205	162	864	50	38	898	130

Note: The southbound movement is considered as the minor approach and the eastbound and westbound movements as the major approach.

Intersection Input Values	
Major =	2 Lane(s)
Minor =	2 Lane(s)
Reduced Volumes (Y/N)? ^c N	

Required Traffic Volumes		
Condition A Use	Major	Minor
	600	200
Condition B Use	Major	Minor
	900	100
Combination A & B Use for Condition A & for Condition B	Major	Minor
	480	160
	720	80

Results of Warrant 1 Analysis					
Time Begin	Main Line	Minor - Southbound Approach	Warrant #1		
			Condition A	Condition B	Condition A&B
6:00 AM	1434	43	0	0	0
7:00 AM	2194	92	0	0	0
8:00 AM	2038	102	0	1	0
9:00 AM	1714	118	0	1	0
10:00 AM	1341	136	0	1	0
11:00 AM	1465	167	0	1	1
12:00 PM	1647	205	1	1	1
1:00 PM	1618	192	0	1	1
2:00 PM	1804	195	0	1	1
3:00 PM	2241	180	0	1	1
4:00 PM	2456	217	1	1	1
5:00 PM	2565	214	1	1	1
6:00 PM	2142	242	1	1	1
Number of Hours Satisfied?			4	11	8
Condition Satisfied?			No	Yes	Yes

Eight Hours must be satisfied to satisfy Warrant #1
 ***Results

Lenhart Traffic Consulting, Inc.	TSWA @ Old Columbina Pike & Shopping Center Access Under Existing Conditions **** Warrant #1 is Satisfied ****	Exhibit D-3a
Traffic Engineering & Transportation Planning		

Figure 4C-1. Warrant 2, Four-Hour Vehicular Volume

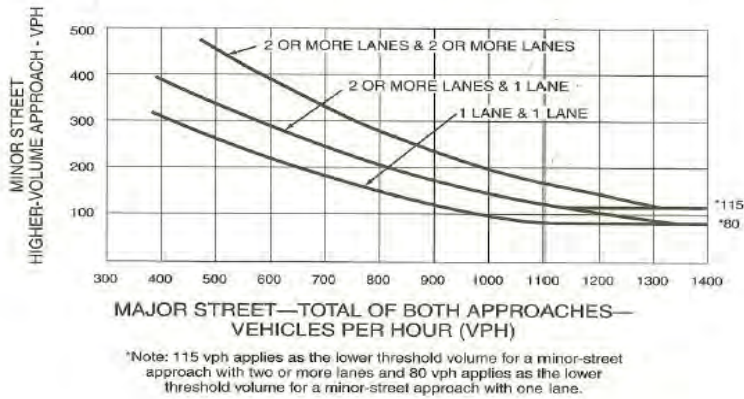
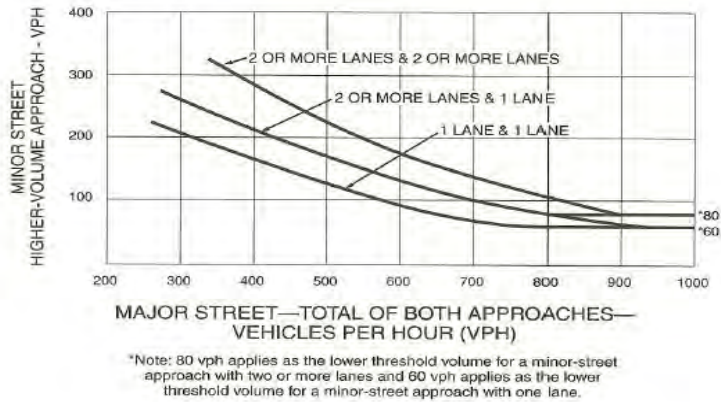

Figure 4C-2. Warrant 2, Four-Hour Vehicular Volume (70% Factor)

(COMMUNITY LESS THAN 10,000 POPULATION OR ABOVE 70 km/h OR ABOVE 40 mph ON MAJOR STREET)



Intersection Input Values

Major = 2 Lane(s)
 Minor = 2 Lane(s)

Reduced Volumes (Y/N)? N

Results of Warrant 2 Analysis

Time Begin	Main Line	Minor - Southbound Approach	Warrant #2	
			Regular	Reduced (70% Factor)
6:00 AM	1434	43		0
7:00 AM	2194	92		0
8:00 AM	2038	102		0
9:00 AM	1714	118		1
10:00 AM	1341	136		1
11:00 AM	1465	167		1
12:00 PM	1647	205	N/A	1
1:00 PM	1618	192		1
2:00 PM	1804	195		1
3:00 PM	2241	180		1
4:00 PM	2456	217		1
5:00 PM	2565	214		1
6:00 PM	2142	242		1
Number of Hours Satisfied?			0	10
Warrant 2 Satisfied?			No	Yes

← 4 Hours Required

Lenhart Traffic Consulting, Inc.

Traffic Engineering & Transportation Planning

Description of Warrant 2 Under Existing Conditions

**** Warrant #2 is Satisfied ****

Exhibit

D-3b

13-Hour Turning Movement Count (6:00 am - 7:00 pm)

Time:	West Site Access Northbound				Shopping Center Access Southbound				MD 198 Eastbound				MD 198 Westbound				Total
	Left	Thru	Right	Peds	Left	Thru	Right	Peds	Left	Thru	Right	Peds	Left	Thru	Right	Peds	
6:00-6:15	0	0	2	1	1	0	6	0	8	101	17	0	15	140	7	1	299
6:15-6:30	1	0	1	4	1	0	10	0	12	116	14	0	21	133	5	0	318
6:30-6:45	0	0	1	0	5	0	8	1	10	184	11	0	21	218	3	0	462
6:45-7:00	0	0	0	0	3	0	9	0	15	150	9	0	22	195	7	0	410
7:00-7:15	0	0	5	0	0	0	15	0	16	143	14	1	27	263	21	0	505
7:15-7:30	3	0	5	1	7	0	15	0	12	185	14	0	19	275	9	0	545
7:30-7:45	1	0	3	0	2	0	27	0	17	219	12	0	25	335	5	0	646
7:45-8:00	1	0	7	2	1	0	25	0	29	215	21	0	12	291	15	0	619
8:00-8:15	2	0	2	1	5	3	22	0	35	212	12	0	9	295	17	0	615
8:15-8:30	2	0	3	0	4	0	24	1	35	222	16	0	7	208	15	0	537
8:30-8:45	2	0	4	0	2	1	20	0	23	190	9	0	10	220	17	0	498
8:45-9:00	3	0	2	0	0	1	20	1	34	204	12	1	8	212	16	0	514
9:00-9:15	4	0	3	0	5	0	24	1	31	142	14	0	15	203	25	0	467
9:15-9:30	2	0	4	4	3	1	28	0	39	212	17	0	12	180	16	0	518
9:30-9:45	2	1	3	0	0	0	30	0	30	197	11	0	8	169	15	0	466
9:45-10:00	3	0	0	0	5	1	21	0	38	160	9	0	10	140	21	0	408
10:00-10:15	3	0	4	1	4	1	19	1	32	125	10	0	10	141	16	1	368
10:15-10:30	2	1	1	0	5	2	29	0	32	148	9	0	6	122	21	0	378
10:30-10:45	2	0	5	0	3	2	35	0	33	130	12	0	11	134	23	1	391
10:45-11:00	2	0	2	1	6	2	28	0	29	139	7	0	10	120	21	0	367
11:00-11:15	3	0	4	5	3	2	24	0	24	133	12	0	14	140	33	0	397
11:15-11:30	4	0	4	0	4	1	40	0	42	139	11	0	12	120	37	0	414
11:30-11:45	2	0	5	0	2	1	41	0	37	147	16	0	14	136	29	0	430
11:45-12:00	0	0	3	2	11	0	38	0	49	135	10	0	10	136	29	0	423
12:00-12:15	3	0	4	0	10	1	50	0	48	168	12	0	12	143	32	0	483
12:15-12:30	2	0	6	1	5	1	43	1	33	148	12	0	16	148	34	0	450
12:30-12:45	0	0	4	1	4	2	36	1	39	154	8	0	9	158	41	0	457
12:45-1:00	4	3	4	0	12	3	38	0	43	169	21	0	11	139	49	0	496
1:00-1:15	1	1	6	0	6	0	50	0	43	164	9	0	20	158	39	0	497
1:15-1:30	4	0	7	0	5	1	33	1	41	158	15	0	9	172	18	0	464
1:30-1:45	4	1	2	1	8	1	44	1	31	167	12	1	7	154	39	0	473
1:45-2:00	0	0	3	1	5	1	38	2	26	141	7	2	10	144	34	0	414
2:00-2:15	1	1	5	0	6	5	49	1	30	146	7	0	14	167	32	0	464
2:15-2:30	2	1	2	0	5	3	44	2	40	153	13	0	11	183	19	0	478
2:30-2:45	2	4	6	1	13	1	30	2	31	179	11	0	14	208	25	0	527
2:45-3:00	1	0	4	0	3	3	33	0	36	216	16	1	9	214	30	0	566
3:00-3:15	3	0	4	1	3	2	38	0	32	208	12	0	15	221	31	0	570
3:15-3:30	0	0	6	1	7	2	40	0	34	242	9	0	15	237	26	0	619
3:30-3:45	0	1	4	1	3	0	28	3	46	225	8	0	11	228	39	0	597
3:45-4:00	4	0	3	0	4	1	52	0	48	286	12	0	13	216	27	0	666
4:00-4:15	3	1	2	0	4	2	41	0	58	263	13	0	21	277	38	0	723
4:15-4:30	2	0	4	1	8	2	45	4	33	263	10	0	11	245	30	0	658
4:30-4:45	0	1	6	1	10	1	45	0	32	249	11	0	12	256	36	0	660
4:45-5:00	2	0	3	0	12	1	46	0	44	234	13	0	7	264	36	0	662
5:00-5:15	1	0	4	0	8	3	50	0	42	264	13	0	12	291	26	0	714
5:15-5:30	2	0	2	0	7	2	44	0	30	233	11	0	13	290	36	0	670
5:30-5:45	0	1	6	0	5	3	39	3	37	262	13	0	18	289	29	1	706
5:45-6:00	3	0	1	0	5	1	47	0	55	255	10	0	9	291	36	0	713
6:00-6:15	0	0	4	0	6	0	47	1	41	243	19	0	12	249	44	0	666
6:15-6:30	1	1	5	1	5	2	50	0	42	218	12	0	11	222	24	0	594
6:30-6:45	5	1	2	1	7	4	54	0	44	210	9	0	10	218	37	0	602
6:45-7:00	0	2	4	2	11	2	54	0	35	193	10	0	5	209	25	0	552

	West Site Access Northbound				Shopping Center Access Southbound				MD 198 Eastbound				MD 198 Westbound				Total
	Left	Thru	Right	Peds	Left	Thru	Right	Peds	Left	Thru	Right	Peds	Left	Thru	Right	Peds	
Hourly Totals																	
6:00-7:00	1	0	4	5	10	0	33	1	45	551	51	0	79	686	22	1	1489
7:00-8:00	5	0	20	3	10	0	82	0	74	762	61	1	83	1164	50	0	2315
8:00-9:00	9	0	11	1	11	5	86	2	127	828	49	1	34	935	65	0	2164
9:00-10:00	11	1	10	4	13	2	103	1	138	711	51	0	45	692	77	0	1859
10:00-11:00	9	1	12	2	18	7	111	1	126	542	38	0	37	517	81	2	1504
11:00-12:00	9	0	16	7	20	4	143	0	152	554	49	0	50	532	128	0	1664
12:00-1:00	9	3	18	2	31	7	167	2	163	639	53	0	48	588	156	0	1886
1:00-2:00	9	2	18	2	24	3	165	4	141	630	43	3	46	628	130	0	1848
2:00-3:00	6	6	17	1	27	12	156	5	137	694	47	1	48	772	106	0	2035
3:00-4:00	7	1	17	3	17	5	158	3	160	961	41	0	54	902	123	0	2452
4:00-5:00	7	2	15	2	34	6	177	4	167	1009	47	0	51	1042	140	0	2703
5:00-6:00	6	1	13	0	25	9	180	3	164	1014	47	0	52	1161	127	1	2803
6:00-7:00	6	4	15	4	29	8	205	1	162	864	50	0	38	898	130	0	2414

Peak Hour
Turning Movement Count

Intersection: MD 198 & West Site Access/Shopping Center Access
 Weather: Clear
 Count by: Count Cam
 Count Day/Date:
 County: Montgomery



Appendix E

Streetlight Verification

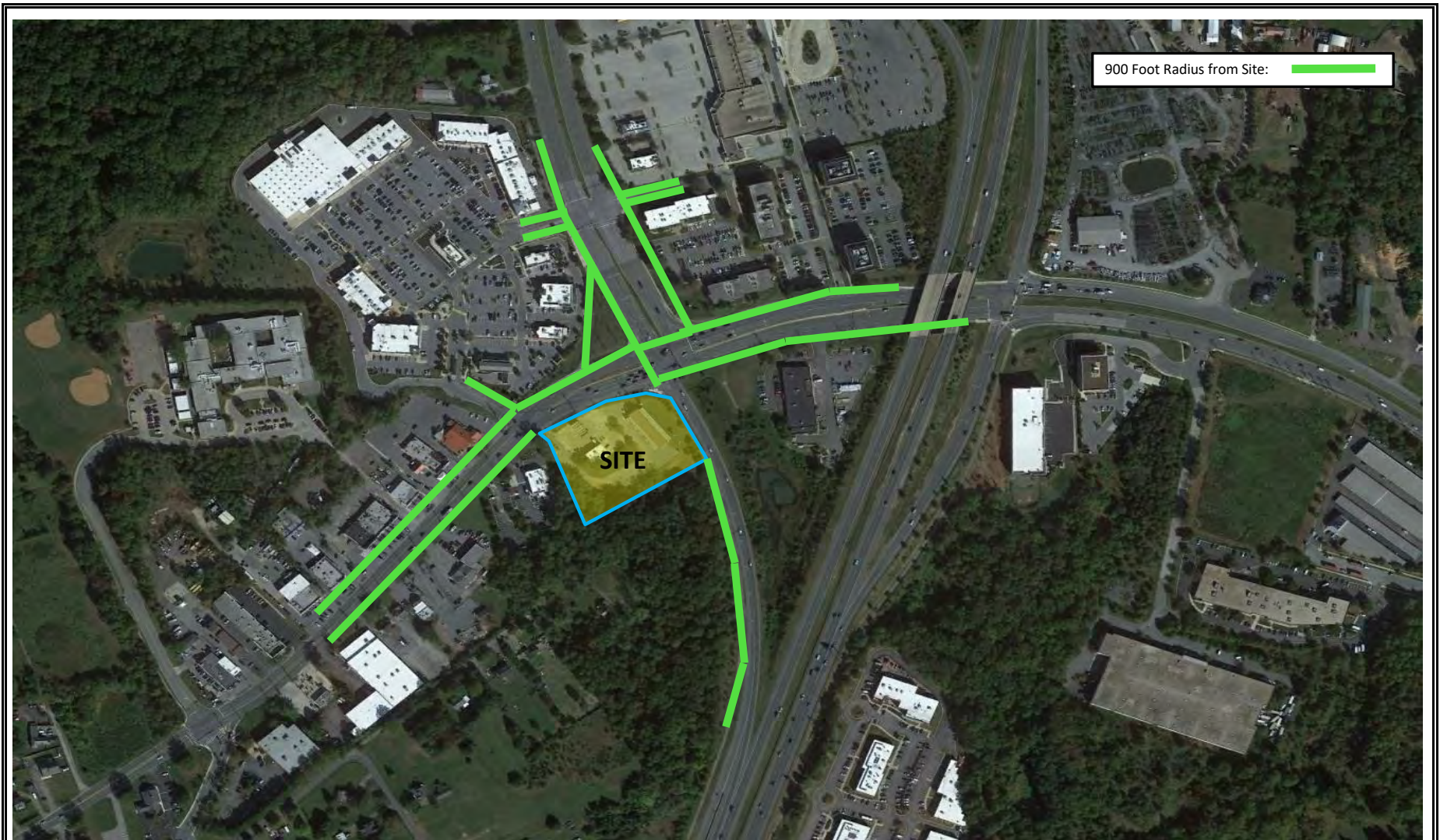

<p>Transportation Facilities Analysis</p>	<p>Pedestrian Evaluation Area Streetlights</p>	<p>Exhibit E-1</p>
<p>Lenhart Traffic Consulting, Inc. Traffic Engineering & Transportation Planning</p>		



Transportation Facilities Analysis	Streetlight Verification	Exhibit E-2
Lenhart Traffic Consulting, Inc. Traffic Engineering & Transportation Planning		

Post ID (From Exhibit E-2)	Post Located at Intersection	Section	Distance from Back of Curb (ft)	Distance from Edge of Pavement (ft)	Distance from Streetside of Sidewalk (ft)	Distance from Back of Sidewalk (ft)	Distance from Trails, Sidepaths and Separated Bike Lanes (ft)	Spacing (ft)	Luminaire Functioning?
1	No	Open			11.5	1.5		118	Yes
2	No	Open			12	2		119	Yes
3	No	Open			12.5	2		125	Yes
4	No	Open			13	2.5		130	Yes
5	No	Open			13	3		121	Yes
6	No	Open			12	3		113	Yes
7	No	Open			12	2		119	Yes
8	No	Open				2		203	Yes
9	No	Closed	12	12.5				163	Yes
10	Yes	Closed	5	5.5				73	Yes
11	Yes	Closed	1	1.5					Yes
12	No	Closed	5	5.5				125	Yes
13	No	Closed	4.5	5					Yes
14	No	Closed	7	7.5					Yes
15	No	Closed	2.5	3					Yes
16	Yes	Closed	3	3.5	2	12		100	Yes
17	No	Closed	1	1.5	3.5	11.5		145	Yes
18	No	Closed	1.5	2	3.5	11.5		106	Yes
19	No	Closed	1	1.5	3.5	11.5		306	Yes
20	No	Closed	16	16.5	13	5			Yes
21	No	Closed			14	8			Yes
22	No	Closed	8.5	9	6.5	1.5		87	Yes
23	Yes	Closed	33	33.5	31	26		99	No
24	No	Closed	9.5	10	7.5	2.5		98	Yes
25	No	Closed	23	23.5	21	16		91	Yes
26	No	Closed	11.5	12	9.5	4.5		163	Yes
27	No	Closed	8	8.5	8	3			Yes
28	No	Closed	8.5	9	7	2		54	Yes
29	No	Closed	7	7.5	7	2		53	Yes
30	No	Closed	7	7.5	7	2			Yes
31	No	Closed	17.5	18	17.5	11.5		142	Yes
32	No	Closed	9.5	10	9.5	3.5		220	Yes
33	No	Closed						105	Yes
34	No	Closed						125	Yes
35	No	Closed	8	8.5	8	3		178	Yes
36	No	Closed	9.5	10	7	2			Yes

Transportation Facilities Analysis	Streetlight Verification	Exhibit E-3
Lenhart Traffic Consulting, Inc. Traffic Engineering & Transportation Planning		

Appendix E

Speed Studies

District: _____
 County: Montgomery
 Location: MD 198, 900 feet east of intersection with Old Columbia Pike (west)
 Date: 9/21/2023
 Time: 1:20 PM

Direction	Eastbound	Westbound
Observation #	Speed (MPH)	Speed (MPH)
1	25	42
2	29	34
3	26	29
4	28	34
5	22	41
6	37	38
7	27	23
8	32	29
9	29	33
10	35	32
11	31	33
12	34	35
13	27	33
14	33	36
15	40	40
16	29	40
17	34	43
18	25	36
19	30	37
20	31	35
21	24	26
22	38	26
23	22	29
24	36	38
25	28	32
26	30	35
27	29	38
28	29	35
29	35	32
30	31	31
31	32	28
32	28	35
33	25	26
34	28	31
35	33	31
36	31	23
37	33	34
38	25	30
39	28	33
40	40	36
41	30	29
42	24	28
43	26	30
44	25	38
45	28	41
46	26	36
47	32	40
48	29	31
49	34	24
50	28	29

EB - 50th Percentile Speed 29 MPH
 EB - 85th Percentile Speed 34 MPH
 WB - 50th Percentile Speed 33 MPH
 WB - 85th Percentile Speed 38 MPH

District: _____
 County: Montgomery
 Location: MD 198, 500 feet west of intersection with US 29 NB Ramps
 Date: 9/21/2023
 Time: 2:00 PM

Direction	Eastbound	Westbound
Observation #	Speed (MPH)	Speed (MPH)
1	20	39
2	29	32
3	23	34
4	33	28
5	28	39
6	25	29
7	25	31
8	31	30
9	30	27
10	27	35
11	29	35
12	31	37
13	29	38
14	33	46
15	28	42
16	32	44
17	29	32
18	33	39
19	31	40
20	37	35
21	33	31
22	36	27
23	31	36
24	28	38
25	36	29
26	18	34
27	27	35
28	31	42
29	28	37
30	27	37
31	26	48
32	30	45
33	28	40
34	33	38
35	33	31
36	29	36
37	28	30
38	28	45
39	24	38
40	21	35
41	31	37
42	34	34
43	30	40
44	27	45
45	25	42
46	44	39
47	29	33
48	27	40
49	22	43
50	30	39

EB - 50th Percentile Speed 29 MPH
 EB - 85th Percentile Speed 33 MPH
 WB - 50th Percentile Speed 37 MPH
 WB - 85th Percentile Speed 42 MPH

District: _____
 County: Montgomery County
 Location: Old Columbia Pike, 500 feet north of National Drive/Shopping Center
 Date: 9/21/2023
 Time: 2:45 PM

Direction	Northbound	Southbound
Observation #	Speed (MPH)	Speed (MPH)
1	40	42
2	50	46
3	43	51
4	41	50
5	47	51
6	49	50
7	43	47
8	37	47
9	51	50
10	33	51
11	50	40
12	48	45
13	45	45
14	51	52
15	52	40
16	54	47
17	44	39
18	42	47
19	44	40
20	49	46
21	30	47
22	55	43
23	49	42
24	36	44
25	41	40
26	51	49
27	48	42
28	47	47
29	45	49
30	52	42
31	51	50
32	37	52
33	52	40
34	47	40
35	38	40
36	45	46
37	41	51
38	44	53
39	43	40
40	53	39
41	42	46
42	35	39
43	42	46
44	39	50
45	42	52
46	46	49
47	44	50
48	50	40
49	43	42
50	42	48

NB - 50th Percentile Speed 45 MPH

NB - 85th Percentile Speed 51 MPH

SB - 50th Percentile Speed 46 MPH

SB - 85th Percentile Speed 51 MPH

Note: Due to the ongoing construction at the Burtonsville Crossing shopping center northbound vehicle traffic is not operating with typical conditions. Northbound speeds were obtained from a speed study conducted in 2022.

District: _____
 County: Montgomery County
 Location: Old Columbia Pike, 500 feet north of National Drive/Shopping Center
 Date: 9/21/2023
 Time: 2:45 PM

Direction	Northbound	Southbound
Observation #	Speed (MPH)	Speed (MPH)
51		
52		
53		
54		
55		
56		
57		
58		
59		
60		
61		
62		
63		
64		
65		
66		
67		
68		
69		
70		
71		
72		
73		
74		
75		
76		
77		
78		
79		
80		
81		
82		
83		
84		
85		
86		
87		
88		
89		
90		
91		
92		
93		
94		
95		
96		
97		
98		
99		
100		