Capital Budget Process

INTRODUCTION

This section provides a brief introduction to the County government and the capital budget process. The purpose of this section is to acquaint the reader with the organization of this document and to familiarize the reader with the companion Recommended Public Services Program (PSP)/Operating Budget document. A glossary of budget terms and concepts, including acronyms, used in this document is contained elsewhere in this document.

THE BUDGET PROCESS

Authority

The Montgomery County Charter, approved by the voters in 1968 and implemented in 1970, provides for a County Council/Executive form of government. Under this form of government, the Executive develops and recommends budget proposals, and the Council then authorizes expenditures and sets property tax rates. The Charter also provides for an annual six-year Public Services Program, Operating Budget, and Capital Budget, and a biennial six-year Capital Improvements Program (CIP). These budgets and related fiscal and programmatic plans provide the basis for understanding, coordinating, and controlling County government programs and expenditures.

Requirements for submission of, and action on, County budgets are contained in Article 3 of the County Charter. Copies of the Charter are available at Council offices and can also be found by following the hypertext links on the County web site at www.montgomerycountymd.gov/govtmpl.asp. State laws govern budgeting practices for MCPS, Montgomery College, M-NCPPC, and WSSC and provide for an annual CIP for WSSC.

Fiscal Year

The 12-month period used to account for revenues and expenditures in Montgomery County commences on July 1 of each year and ends on June 30 of the following year. A timeline appears at the end of this section.

Operating and Capital Budgets

Under the Charter (Section 303), the County Executive's Recommended Budget includes the Capital Improvements Program (CIP), published by January 15 in even-numbered calendar years; the Capital Budget, published annually by January 15; and the Public Services Program (PSP)/Operating Budget, published annually by March 15. The Charter was amended in 1996 to change the annual requirement for a CIP to

a Capital Budget each year and a CIP for periods beginning in odd-numbered fiscal years.

The proposed budgets must identify all recommended expenditures and the revenues used to fund the budgets. For further information about the PSP/Operating Budget process, please refer to the Operating Budget Process section of the most recent County Executive's Recommended Public Services Program.

The Charter (Section 305) places restrictions on increases in annual budgets, excluding the operating budgets of non-tax supported Enterprise Funds, WSSC, the bi-county portion of M-NCPPC, and Washington Suburban Transit Commission (WSTC). The aggregate budget cannot grow more than the Consumer Price Index-Urban (CPI-U) for all urban consumers in the Washington-Metropolitan area from November to November without at least six votes of the County Council.

Other sections of the Charter prohibit expenditure of County funds in excess of available unencumbered appropriations and the use of long term debt to fund current operating expenses.

Spending Affordability Process

The spending affordability process for the Capital Improvements Program is required by Section 305 of the County Charter and Chapter 20 of the Montgomery County Code and begins by September of each odd-numbered calendar year.

The County Charter was amended in 1990 to include a limit on the annual increase in property tax revenues. Real property tax revenues, with the exception of new construction and property whose zoning or use has changed, may not increase by more than the prior year revenues plus the percentage increase in the Washington area CPI-U unless seven Councilmembers vote to exceed that limit. In addition, the County Council must adopt annual spending affordability guidelines for both the operating and capital budgets which can only be exceeded prior to setting appropriations by a vote of seven of the nine Councilmembers.

By the first Tuesday in October and after a public hearing, the County Council must set Spending Affordability Guidelines (SAG) for the bonds planned for issue (both general obligation and Park and Planning bonds) for years one and two of the six-year program and for the total six-year program. In adopting SAG, the Council considers, among other relevant factors:

- growth in the assessable base and estimated revenues from the property tax;
- other estimated revenues;
- Countywide debt capacity;

- relative tax burden on County taxpayers;
- the level of inflation and inflation trends;
- demographic trends, including population and education enrollment;
- commercial construction, housing, and other building activity; and
- employment levels.

By the first Tuesday in February, the Council may increase, by up to ten percent, or decrease the guidelines to reflect a significant change in conditions by a simple majority vote.

If the final Capital Improvements Program budget exceeds the guidelines then in effect, seven affirmative votes are required.

Capital Budget/CIP Preparation and Executive Review

Departments and agencies prepare budget requests within guidelines established by the Executive (for the departments) and by law (for other agencies of government). These are submitted on scheduled dates for analysis by the Office of Management and Budget (OMB) and are reviewed by the Executive during the period September - December. The review process culminates in final decisions and Executive recommendations in the budget document submitted to the Council by January 15.

Public Hearings

Citizen participation is essential to a fair and effective budget process. Many citizens and advisory groups work with specific departments to ensure that their concerns are addressed in departmental requests. The County Charter requires the Council to hold a public hearing not earlier than 21 days after receipt of the budget from the Executive. For further information and dates of the Council's public hearings on the County Executive's Recommended Capital Budget/CIP, contact the Legislative Information Office at 240.777.7900. Hearings are held in the Council Hearing Room of the Stella B. Werner Council Office Building, unless otherwise specified.

Public hearings are advertised in County newspapers. Speakers must register with the Council Office to testify at the public hearings. Persons wishing to testify should call the Council Office to register at 240.777.7931. If it is not possible to testify in person at the hearings, written testimony is acceptable and encouraged.

Council Budget Review

After receiving input from the public, the Council begins its review of the Executive's Recommended Capital Budget/CIP. Each category area and agency program is reviewed by a designated Council committee. Agency and OMB representatives meet with these committees to provide information and clarification concerning the recommended budget and six-year plan for each project. In April and May,

the full Council meets in regular session, reviews the recommendations of its Committees, and takes final action on each project.

Operating and Capital Budget Approval

The Charter requires that the Council approve and make appropriations annually for the operating and capital budgets by June 1. In even-numbered calendar years, the Council also approves a six-year Capital Improvements Program. Prior to June 30, the Council must set the property tax levies necessary to finance the budgets.

Amending the Approved Operating and Capital Budgets

The operating and capital budgets may be amended at any time after adoption by the Council. The following terms are included in the glossary contained elsewhere in this document:

Supplemental appropriations are recommended by the County Executive, specify the source of funds to finance the additional expenditures, and generally occur after January 1 of the fiscal year. Supplemental appropriations approved before January 1 are made only to comply with, avail the County of, or put into effect the provisions of Federal, State, or local legislation or regulations. Supplemental appropriations must be approved by five of the nine members of the Council.

Special appropriations are recommended by either the County Executive or County Council and are used when it is necessary to meet an unforeseen emergency or disaster or act without delay in the public interest. The Council may approve a special appropriation after a public notice by news release, and each special appropriation must be approved by six of the nine members of the Council.

Transfers of appropriation, which do not exceed ten percent of the original appropriation, may be accomplished by either: the County Executive, where transfers are within or between divisions of the same department; or by the County Council, where transfers are between departments or to new accounts.

Other sections of the Charter provide for Executive veto or reduction of items in the budget approved by the Council and the accumulation of surplus revenues.

Amending the Approved CIP may be done by the County Council at any time for either new projects or changes to existing projects which require appropriation and meet one or more of the following criteria:

- Project leverages significant non-County sources of funds (for example, Federal aid for Bridges, State aid for schools);
- Project is needed to comply with effects of a new law;
- Project is needed to address an *urgent* health or safety concern;

- Project is needed to address an *urgent* school capacity need (for example, adjustment to assure current project meets scheduled September opening or a new project for a newly identified need);
- Project offers the opportunity to achieve *significant* savings or cost avoidance or to generate *significant* additional revenue (for example, the bid has come in lower than budget, allowing funds to be redirected; operating budget savings are documented; fees collected will increase);
- Project is needed to keep transportation or school projects on approved growth policy schedule;
- Project supports *significant* economic development initiatives, which in turn will strengthen the fiscal capacity of the County government;
- Project offers a *significant* opportunity, which will be lost if not taken at this time;
- Project scope adjustment is needed on inter-jurisdictional projects due to changed conditions;
- Project is delayed for policy reasons;
- Project has validated extraordinary inflation (as seen in bids);
- Project must be amended for technical reasons (for example, to implement policy or recognize extraordinary cost increases);
- Project expenditures can be/must be delayed to provide fiscal capacity, given changes in conditions since the Approved CIP was adopted; and
- Project or subproject is proposed to increase: relatively by at least 10 percent and absolutely by at least \$1,000,000 from the last adopted CIP; or absolutely by at least \$2,000,000 from the last adopted CIP.

CAPITAL IMPROVEMENTS PROGRAM AND CAPITAL BUDGET

The CIP covers construction of all public buildings, roads, and other facilities planned by County public agencies over a six-year period. The CIP is an integrated presentation, including capital expenditure estimates, funding requirements, capital budget requests, and program data for all County departments and agencies. The capital budget includes required appropriation expenditures and funding for the forthcoming fiscal year, the first year of the six-year program. An estimate of required appropriations for the second year of the six-year program is also included.

In addition to these documents, the County publishes a growth policy to provide guidance to agencies of government and to citizens on matters concerning land use development; growth management; and related environmental, economic, and social issues. The growth policy serves as a major tool in managing the County's development, and as such, provides significant

guidance in the preparation of the CIP and the commitment of resources in the six-year PSP.

WHY CAPITAL PROGRAMMING?

A coordinated program for the planning, implementation, and financing of public facilities and other physical infrastructure is essential to meet the needs of a County with diverse population and resources. "Capital improvements" are those which, because of expected long-term usefulness, size, and cost, require large expenditures of capital funds usually programmed over more than one year and result in a durable capital asset. The largest single source of capital project financing is tax-exempt bonds. The bonds are issued as general obligations of the County, by a self-supporting agency, or as an obligation of the revenues supporting a specific project. The debt service on these bonds--the repayment of principal and interest over the life of the bonds--becomes one of the items in the annual operating budget and, thus, a factor in the annual tax rate. Also, the County's fiscal policy sets certain limits on the total amount of debt that can be incurred in order to maintain fiscal stability and the highest available quality rating for County bonds, thereby obtaining the lowest interest rate. It is, therefore, critical that the CIP be both cost-conscious and balanced over the six-year period so that the fiscal impact will not weigh too heavily in any single year.

The objectives of the CIP may be summarized as:

- To build those facilities required to support the County's PSP objectives.
- To support the physical development objectives incorporated in approved County plans, especially land use master plans as controlled by the County's General Plan, growth policy, and Adequate Public Facilities Ordinance.
- To assure the availability of public improvements to provide site opportunities to accommodate and attract private development consistent with approved developmental objectives.
- To improve financial planning by comparing needs with resources, estimating future bond issues, plus debt service and other current revenue needs, and, thus, identifying future operating budget, tax rate, and debt capacity implications.
- To establish priorities among projects so that limited resources are used to the best advantage.
- To identify, as accurately as possible, the impacts of public facility decisions on future operating budgets, in terms of energy use, maintenance costs, and staffing requirements.
- To provide a concise, central source of information on all planned public construction for citizens, agencies, and other interest groups.
- To provide a basis for effective public participation in decisions related to public facilities and other physical improvements.

While the County's planning and programming process is established, the CIP is improved and refined from year to year in order to seek the most effective means of providing needed public facilities in a timely and fiscally-responsible manner.

CIP IMPACTS ON THE OPERATING BUDGET

The CIP impacts the operating budget in several ways:

Debt Service. The annual payment of principal and interest on general obligation bonds and other long-term debt used to finance roads, schools, and other major projects is included in the operating budget as a required expenditure.

Current Revenue Funding. Selected CIP projects are funded directly with County current revenues in order to avoid costs of borrowing. These amounts are included in the operating budget as specific transfers to individual projects within the capital projects fund.

Pay-As-You-Go (PAYGO) Financing. An additional amount may be included in the operating budget as a direct bond offset to reduce the amount of borrowing required for project financing.

Operating Budget Impacts. The construction of government buildings and facilities usually results in new annual costs for maintenance, utilities, and additional staffing required for facility management and operation. Whenever a new or expanded facility involves program expansion, as with new school buildings, libraries, or fire stations, the required staffing and equipment (principals, librarians, fire apparatus) represent additional operating budget expenditures. The Executive's Recommended CIP includes analysis of these operating budget impacts to aid in review and decisions relative to the timing of public facilities and to more clearly show what a new building or road will cost in addition to its construction costs and any required debt service.

Public Facilities Planning. Planning for capital improvements projects is tied to the County's continuing development and growth in population, numbers of households, and businesses. Land use master plans and sector plans for the County's geographic planning areas anticipate needs for roads, schools, and other facilities required by new or changing population. Functional plans anticipate needs for government functions and services ranging from provision of water and sewerage to solid waste disposal, libraries, and fire and rescue services. Other studies assess future educational, health, and human services needs of the County. These plans are analyzed for likely new facilities or service delivery requirements and their potential operating costs which will eventually add to annual operating budgets. Each year, the County continues its efforts to improve the linkages between the CIP, the PSP, and County planning activities.

CIP CATEGORIES

One of the features of Montgomery County's capital programming is the classification of County government projects and other agency programs into the categories listed below. These categories classify the activities of local government on a functional basis which is closely related to the County's computerized accounting system. The published CIP documents are organized by categories for County government departments and by agency for organizations outside the Executive departments.

The six-year PSP/Operating Budget also uses a similar category structure to describe functional operating services of the County government and other County agencies. With both the six-year PSP and CIP utilizing these categories as an overall organizational framework, relationships between public facilities and public services can be seen.

CIP Categories/Subcategories

General Government

County Offices and Other Improvements
Economic Development
Fleet Management
Other General Government
Technology Investment Fund
Technology Services

Public Safety

Correction and Rehabilitation
Fire and Rescue Services
Other Public Safety
Police

Transportation

Highway Maintenance
Mass Transit/WMATA
Parking
Pedestrian Facilities/Bikeways
Roads, Bridges, and Traffic Improvements

Sanitation

Solid Waste Management

Under WSSC:

Sewerage (Bi-County)
Sewerage (Montgomery County)
Water (Bi-County)
Water (Montgomery County)

Health and Human Services

Culture and Recreation

Public Libraries

Recreation

Golf Courses (Under Revenue Authority)

Miscellaneous Revenue Authority Projects

Conservation of Natural Resources

Agricultural Land Preservation

Storm Drains

Stormwater Management

Parks Acquisition (under M-NCPPC)

Parks Development (under M-NCPPC)

Community Development and Housing

Community Development

Housing

Housing - HOC

Non-Departmental

Education

Countywide (MCPS)

Individual Schools (MCPS)

Higher Education (Montgomery College)

SPECIAL PROJECTS LEGISLATION

In November 1978, the County Charter was amended to require certain County funded special capital improvement projects be individually authorized by law. The County Executive and County Council have fulfilled this obligation each year, affording citizens of Montgomery County greater opportunity to participate in the capital budget process and to petition projects to referendum at the next scheduled election.

Section 302 of the County Charter and Section 20-1 of the County Code require that all capital improvement projects which meet any of the following criteria be individually authorized by law: all capital projects, except those excluded by law, which are in excess of the annually revised cost criterion; all capital projects which are determined by the County Council to possess unusual characteristics; or any capital project which is determined to be of sufficient public importance to warrant special legislation. Section 20-1 of the County Code applies special capital improvement project requirements to all buildings, roads, utilities, parks, and related improvements which are proposed for development on a single, unified site, are identifiable as separate facilities, and meet one of the three County Charter criteria described above.

The cost criterion used to determine whether a project needs special legislation is revised each year by Executive Order and reflects the annual change in the published composite cost index established by the U.S. Department of Commerce. The cost criterion applicable to projects in the FY11 Capital Budget and the FY11-16 Capital Improvements Program is \$12,863,000.

The Status of Special Capital Improvements Projects Legislation report in this chapter's appendices shows the capital improvement projects for which special authorization is requested and those not subject to authorization, but which exceed the cost limit.

Public hearings, as required by law for all legislation, will be conducted in the spring, and any special capital improvement authorization enacted by the County Council is valid for five years after the authorization becomes law. The Council may reauthorize a project before or after an existing authorization expires. An authorized project need not be reauthorized if a contract for construction of the project is executed before the authorization expires. These requirements do not apply to projects financed with Revenue Bonds.

GOVERNMENT STRUCTURE

Montgomery County includes several organizational components and joint ventures, including:

Montgomery County Government (MCG), which includes Executive departments (such as Recreation, Transportation, Police) and offices (such as County Attorney), the County Council's legislative offices and boards, the Circuit Court, and judicial offices;

Montgomery County Public Schools (MCPS), under the authority of the Board of Education (BOE);

Montgomery College (MC), the County's two-year community college, under the authority of its Board of Trustees;

Maryland-National Capital Park and Planning Commission (M-NCPPC), a bi-county agency which manages public parkland and provides land use planning, with administration shared with Prince George's County;

Washington Suburban Sanitary Commission (WSSC), a bi-county agency which provides water and sewer service to Montgomery and Prince George's Counties;

Housing Opportunities Commission (HOC), the County's public housing authority;

Montgomery County Revenue Authority, a public corporation for self-supporting enterprises of benefit to the County; and

Bethesda Urban Partnership, a not-for-profit organization, executes contracts for the benefit of one of the primary Government's special taxing districts (Bethesda Urban District).

Along with M-NCPPC and WSSC, the following organizations are also considered joint ventures of the County: Washington Suburban Transit Commission (WSTC), Washington Metropolitan Area Transit Authority (WMATA), Metropolitan

Washington Council of Governments (COG), and Northeast Maryland Waste Disposal Authority (NEMWDA).

An organization chart is included at the back of this section to help the reader understand the relationship between the Executive's Recommended Budget and the several agencies of government in Montgomery County.

APPENDICES TO THIS SECTION

Status of Special Capital Improvements Projects Legislation

This report provides the status of Special Capital Improvements legislation for projects that exceed a specific cost criteria provided previously in this section.

Montgomery County Map

This map displays the major roads in the County, and the County's location in the State of Maryland.

Montgomery County Government Public Documents

This table contains a list of all budget-related public documents, including the approximate dates of publication and how they may be obtained.

Budget Process Flow Chart

This chart follows the Capital/CIP and Operating/PSP budget process from the start of the process in August to the final approval of the budgets in June for all agencies.

Montgomery County Functional Organization Chart

This chart displays the organizational structure of departments and agencies for the County government.

STATUS OF SPECIAL CAPITAL IMPROVEMENTS PROJECTS LEGISLATION**Cost Criterion: \$12,863,000**

Project #	Project Title	Total County Funds (\$000s)	Resolution Number	Bill Number	Date	Current Status/ Remarks
------------------	----------------------	--	------------------------------	------------------------	-------------	--

General Government**County Offices and Other Improvements**

361107	Americans with Disabilities Act (ADA): Compliance	20,000				Not Required
850900	DLC Liquor Warehouse	53,119				Not Required
500918	Environmental Compliance: MCG	14,260				Not Required
361111	MCPS Food Distribution Facility Relocation	29,179				Required
508331	Roof Replacement: MCG	14,996				Not Required
150701	Technology Modernization -- MCG	80,209				Not Required

Economic Development

159281	Silver Spring Redevelopment Pgm	26,446				Not Required
--------	---------------------------------	--------	--	--	--	--------------

Other General Government

316222	ALARF: MCG	31,762				Not Required
--------	------------	--------	--	--	--	--------------

Technology Services

509651	Fibernet	50,413				Not Required
340901	Public Safety System Modernization	50,318				Not Required

Public Safety**Fire/Rescue Service**

450101	East Germantown Fire Station	16,262		08-06	5/25/2006	
450900	Glenmont FS 18 Replacement	13,032				Required
450504	Travilah Fire Station	16,034				Required

Other Public Safety

100300	Judicial Center Annex	139,833		23-06	6/13/2006	
470907	PSTA and Multi-Agency Service Park	48,241				Not Required
470906	Public Safety Headquarters	107,440		14-09	5/20/2009	

Police

470302	3rd District Police Station	25,555				Required
470301	6th District Police Station	21,667		13-05	6/28/2005	Reauthorization required
470400	Animal Shelter	23,695		09-06	5/25/2006	

STATUS OF SPECIAL CAPITAL IMPROVEMENTS PROJECTS LEGISLATION**Cost Criterion: \$12,863,000**

Project #	Project Title	Total County Funds (\$000s)	Resolution Number	Bill Number	Date	Current Status/ Remarks
------------------	----------------------	--	------------------------------	------------------------	-------------	--

Transportation**Highway Maintenance**

509928	Brookville Service Park	17,913		7-03	5/14/2003	
500522	North County Maintenance Depot	94,732		10-06	5/25/2006	Reauthorization required
501106	Permanent Patching: Residential/Rural Roads	18,000				Not Required
500914	Residential and Rural Road Rehabilitation	40,297				Not Required
500511	Resurfacing: Residential/Rural Roads	48,791				Not Required
508527	Resurfacing: Primary/Arterial	47,916				Not Required
508182	Sidewalk & Infrastructure Revitalization	37,754				Not Required
500700	Street Tree Preservation	19,050				Not Required

Mass Transit

500929	Bethesda Metro Station South Entrance	60,000		19-08	6/10/2008	
500933	Equipment Maintenance and Operations Center (EMOC)	134,410				Required
500821	Ride On Bus Fleet	85,903				Not Required
509974	Silver Spring Transit Center	32,111				Not Required

Parking

500932	Bethesda Lot 31 Parking Garage	88,819		20-08	6/10/2008	
508250	Pkg Sil Spg Fac Renovations	27,957				Not Required

Pedestrian Facilities/Bikeways

509325	ADA Compliance: Transportation	15,881				Not Required
506747	Annual Sidewalk Program	16,169				Not Required
500905	Falls Road East Side Hiker/ Biker Path	20,790				Required

STATUS OF SPECIAL CAPITAL IMPROVEMENTS PROJECTS LEGISLATION**Cost Criterion: \$12,863,000**

Project #	Project Title	Total County Funds (\$000s)	Resolution Number	Bill Number	Date	Current Status/Remarks
<u>Roads</u>						
500719	Chapman Avenue Extended	12,864				Required
509337	Facility Planning-Transportation	55,926				Not Required
500516	Father Hurley Blvd. Extended	22,160		13-04	5/27/2004	
500717	Montrose Parkway East	58,169		16-08	6/10/2008	
500311	Montrose Parkway West	75,642		12-02	5/23/2002	
500401	Nebel Street Extended	13,931		17-08	6/10/2008	
501109	Snouffer School Road	22,960				Required
500722	State Transportation Participation	90,031				Not Required
500151	Woodfield Road Extended	13,685		18-08	6/10/2008	
<u>Traffic Improvements</u>						
509399	Advanced Transportation Management System	37,336				Not Required
500333	Pedestrian Safety Program	12,975				Not Required
500704	Traffic Signal System Modernization	23,897				Not Required
507154	Traffic Signals	31,119				Not Required
Health and Human Services						
<u>Health and Human Services</u>						
640400	School Based Health & Linkages to Learning Centers	15,709				Not Required
Culture and Recreation						
<u>Libraries</u>						
710300	Gaithersburg Library Renovation	24,629		11-06	5/25/2006	
710301	Olney Library Renovation and Addition	12,909				Required
710302	Silver Spring Library	63,031		24-06	6/13/2006	
<u>Recreation</u>						
720601	Cost Sharing: MCG	17,493				Not Required
720921	Neighborhood Recreation Center Construction	18,662				Not Required
720101	White Oak Community Recreation Center	24,330		15-05	6/28/2005	

STATUS OF SPECIAL CAPITAL IMPROVEMENTS PROJECTS LEGISLATION

Cost Criterion: \$12,863,000

Project #	Project Title	Total County Funds (\$000s)	Resolution Number	Bill Number	Date	Current Status/Remarks
-----------	---------------	-----------------------------	-------------------	-------------	------	------------------------

Conservation of Natural Resources

Ag Land Preservation

788911	Ag Land Pres Easements	18,935				Not Required
--------	------------------------	--------	--	--	--	--------------

Stormwater Management

809319	Facility Planning: SM	13,322				Not Required
--------	-----------------------	--------	--	--	--	--------------

800900	SM Retrofit - Government Facilities	29,157				Not Required
--------	-------------------------------------	--------	--	--	--	--------------

808726	SM Retrofit: Countywide	49,332				Not Required
--------	-------------------------	--------	--	--	--	--------------

Community Development and Housing

Housing

760100	Affordable Housing Acquisition and Preservation	102,500				Not Required
--------	---	---------	--	--	--	--------------

**MONTGOMERY COUNTY PUBLIC DOCUMENTS:
ANNUAL BUDGETS, GROWTH POLICY, AND OTHER SOURCES OF INFORMATION**

<u>DATE</u>	<u>ITEM</u>	<u>AVAILABILITY</u>
January 15 (even calendar years)	COUNTY EXECUTIVE'S RECOMMENDED CAPITAL BUDGET AND CAPITAL IMPROVEMENTS PROGRAM (CIP) County Executive's Transmittal; Introductory Sections; County Government Departments; HOC; Revenue Authority; MCPS; Montgomery College; M-NCPPC; WSSC	www.montgomerycountymd.gov/omb Reference copies at public libraries Office of Management and Budget (240.777.2800) (for purchase on limited basis)
January 15 (odd calendar years)	COUNTY EXECUTIVE'S RECOMMENDED CAPITAL BUDGET AND AMENDMENTS TO (PRIOR YEAR) CAPITAL IMPROVEMENTS PROGRAM County Executive's Transmittal; Capital Budget; Amendments	www.montgomerycountymd.gov/omb
March 15	COUNTY EXECUTIVE'S RECOMMENDED OPERATING BUDGET AND PUBLIC SERVICES PROGRAM County Executive's Transmittal; Financial Summaries; Legislative, Judicial, Executive Branch Departments; MCPS; Montgomery College; M-NCPPC; WSSC	www.montgomerycountymd.gov/omb Reference copies at public libraries Office of Management and Budget (240.777.2800) (for purchase on limited basis)
March 31	FISCAL PLAN Contains estimates of costs and revenues over the six-year planning period for all Montgomery County special and enterprise funds and many Agency funds.	www.montgomerycountymd.gov/omb Office of Management and Budget (240.777.2800)
June 15 (odd calendar years)	PLANNING BOARD RECOMMENDED GROWTH POLICY - STAFF DRAFT	Reference copies from M-NCPPC (301.495.4610)
mid-July (even calendar years)	APPROVED OPERATING AND CAPITAL BUDGETS, AND APPROVED CAPITAL IMPROVEMENTS PROGRAM PSP and CIP Appropriation and Approval Resolutions; Operating Budget, CIP and Capital Budget Summaries; Project Description Forms for County Government Programs, HOC, Revenue Authority, MCPS, Montgomery College, M-NCPPC, and WSSC	www.montgomerycountymd.gov/omb Reference copies at public libraries Office of Management and Budget (240.777.2800) (for purchase on limited basis)
mid-July (odd calendar years)	APPROVED OPERATING AND CAPITAL BUDGETS, AND APPROVED AMENDMENTS TO THE CAPITAL IMPROVEMENTS PROGRAM PSP and CIP Appropriation and Approval Resolutions; Operating and Capital Budget Summaries; and selected Project Description Forms for County Government Programs, HOC, Revenue Authority, MCPS, Montgomery College, M-NCPPC, and WSSC	www.montgomerycountymd.gov/omb Reference copies at public libraries Office of Management and Budget (240.777.2800) (for purchase on limited basis)
August 1 (odd calendar years)	PLANNING BOARD RECOMMENDED GROWTH POLICY - FINAL DRAFT	Reference copies from M-NCPPC (301.495.4610)

**MONTGOMERY COUNTY PUBLIC DOCUMENTS:
ANNUAL BUDGETS, GROWTH POLICY, AND OTHER SOURCES OF INFORMATION**

<u>DATE</u>	<u>ITEM</u>	<u>AVAILABILITY</u>
Late December	COMPREHENSIVE ANNUAL FINANCIAL REPORT	www.montgomerycountymd.gov/finance Reference copies at public libraries Department of Finance (240.777.8822) (on limited basis)
Quarterly	ECONOMIC INDICATORS	www.montgomerycountymd.gov/finance Department of Finance (240.777.8866)
Monthly (To update the Economic Indicators Report)	ECONOMIC UPDATE	www.montgomerycountymd.gov/finance Department of Finance (240.777.8866)
Annually	ANNUAL INFORMATION STATEMENT	Reference copies from the Department of Finance (240.777.8866) (on limited basis)
Available throughout the year	MONTGOMERY COUNTY HISTORICAL SOCIETY INFORMATION	Montgomery County Historical Society (301.340.2825) www.montgomeryhistory.org
Available throughout the year	MONTGOMERY COUNTY DEMOGRAPHIC INFORMATION	Maryland-National Capital Park and Planning Commission: Montgomery County Planning Board (301.495.4600) www.montgomeryplanning.org/research

BUDGET PROCESS FLOW CHART

JULY	AUGUST	SEPTEMBER	OCTOBER	NOVEMBER	DECEMBER
------	--------	-----------	---------	----------	----------

CAPITAL BUDGET (Annual) / CAPITAL IMPROVEMENTS PROGRAM (Biennial)

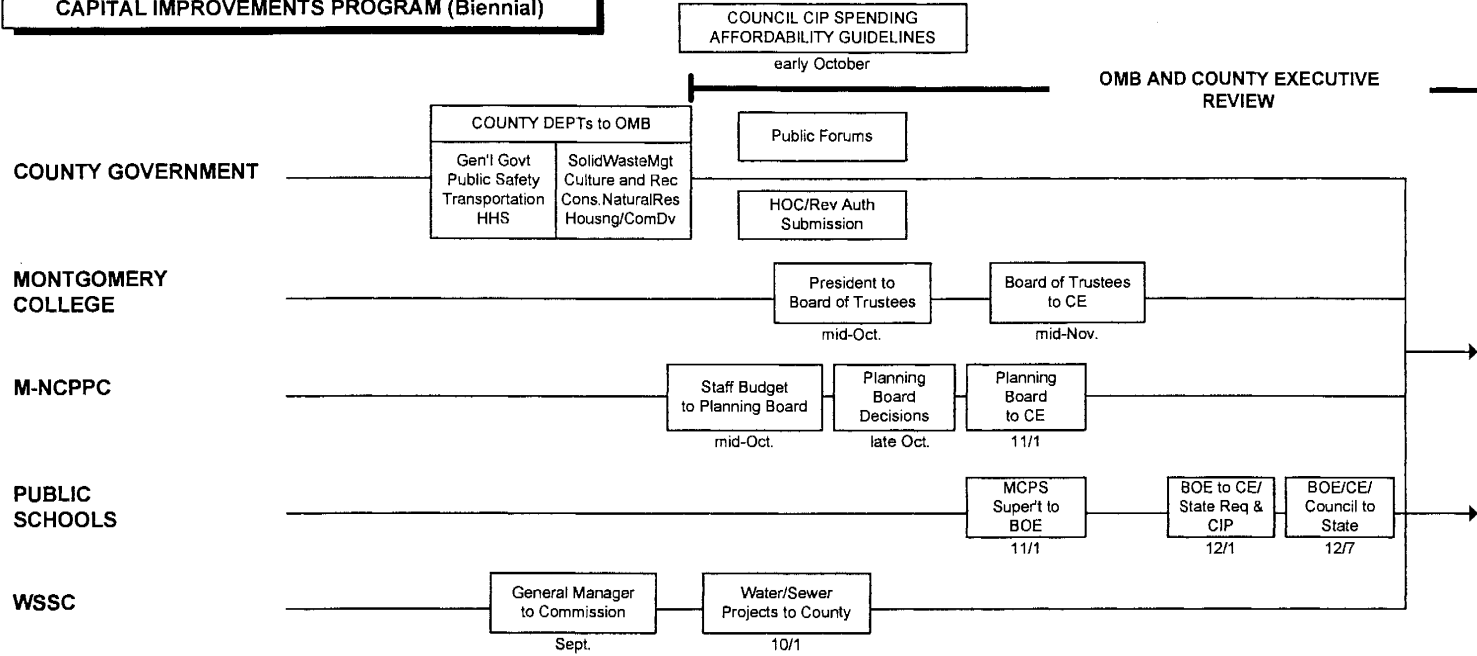

OPERATING BUDGET/PUBLIC SERVICES PROGRAM

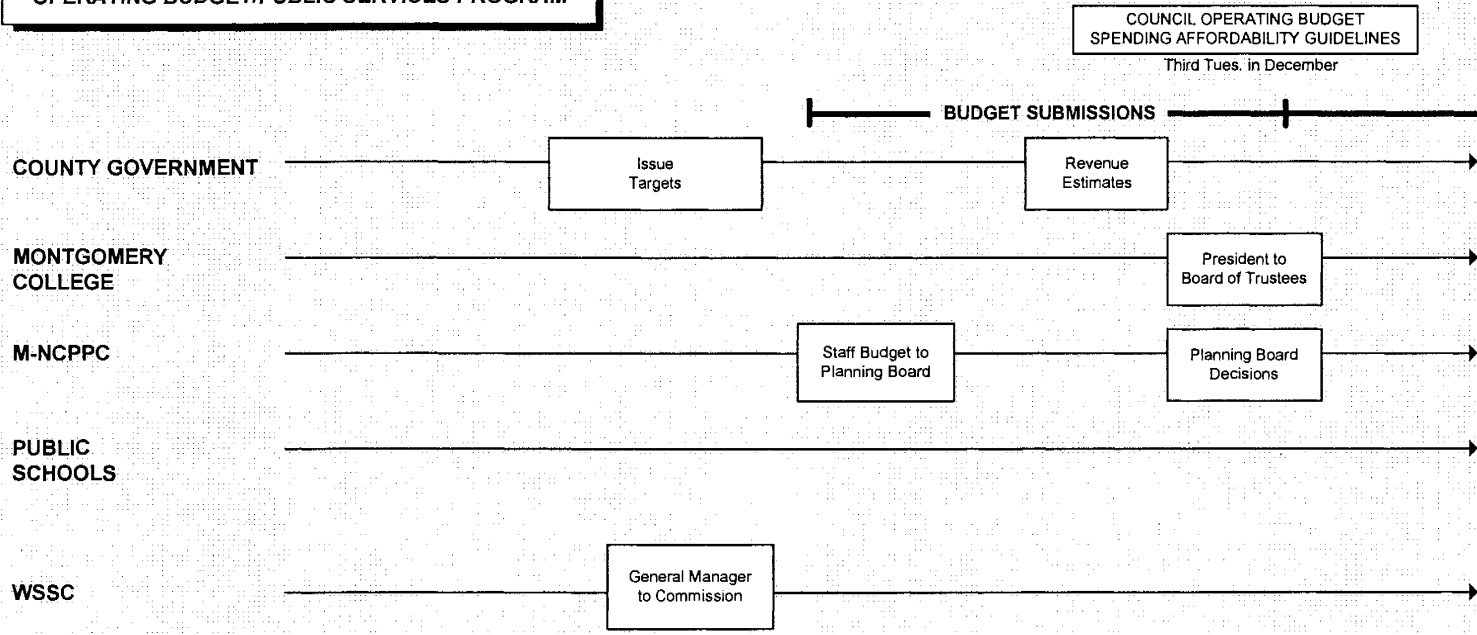

GROWTH POLICY (M-NCPPC)

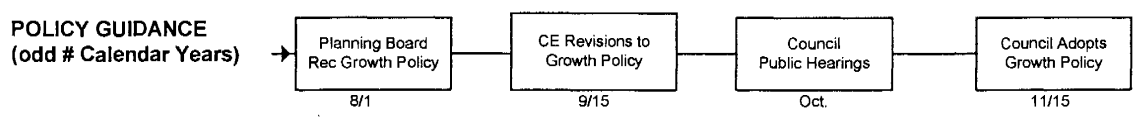

JULY	AUGUST	SEPTEMBER	OCTOBER	NOVEMBER	DECEMBER
------	--------	-----------	---------	----------	----------

JANUARY	FEBRUARY	MARCH	APRIL	MAY	JUNE	JULY
---------	----------	-------	-------	-----	------	------

Council Revisits
CIP SAG

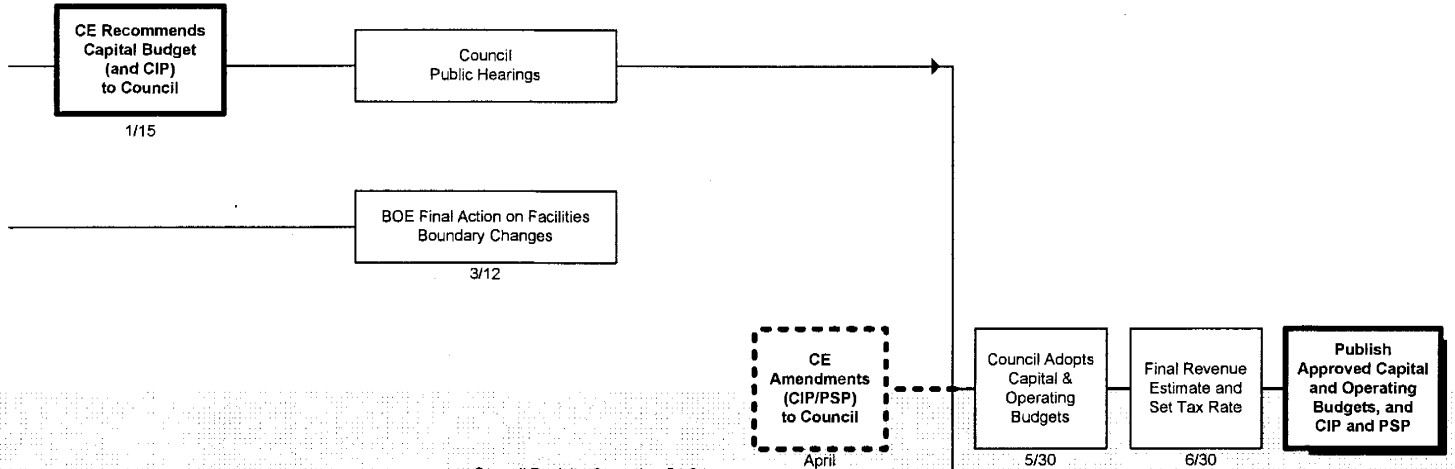
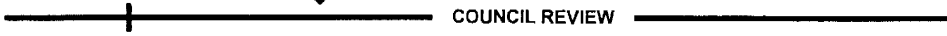

Council Revisits Operating SAG
2nd Tuesday after General Assembly adjourns

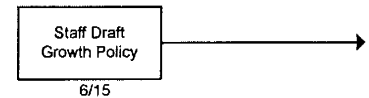
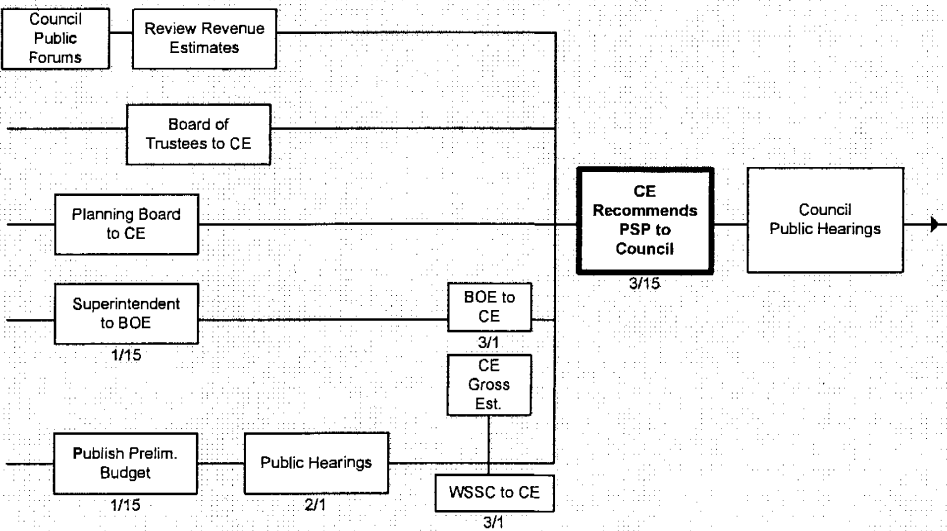

JANUARY	FEBRUARY	MARCH	APRIL	MAY	JUNE	JULY
---------	----------	-------	-------	-----	------	------

Montgomery County, Maryland Functional Organization Chart

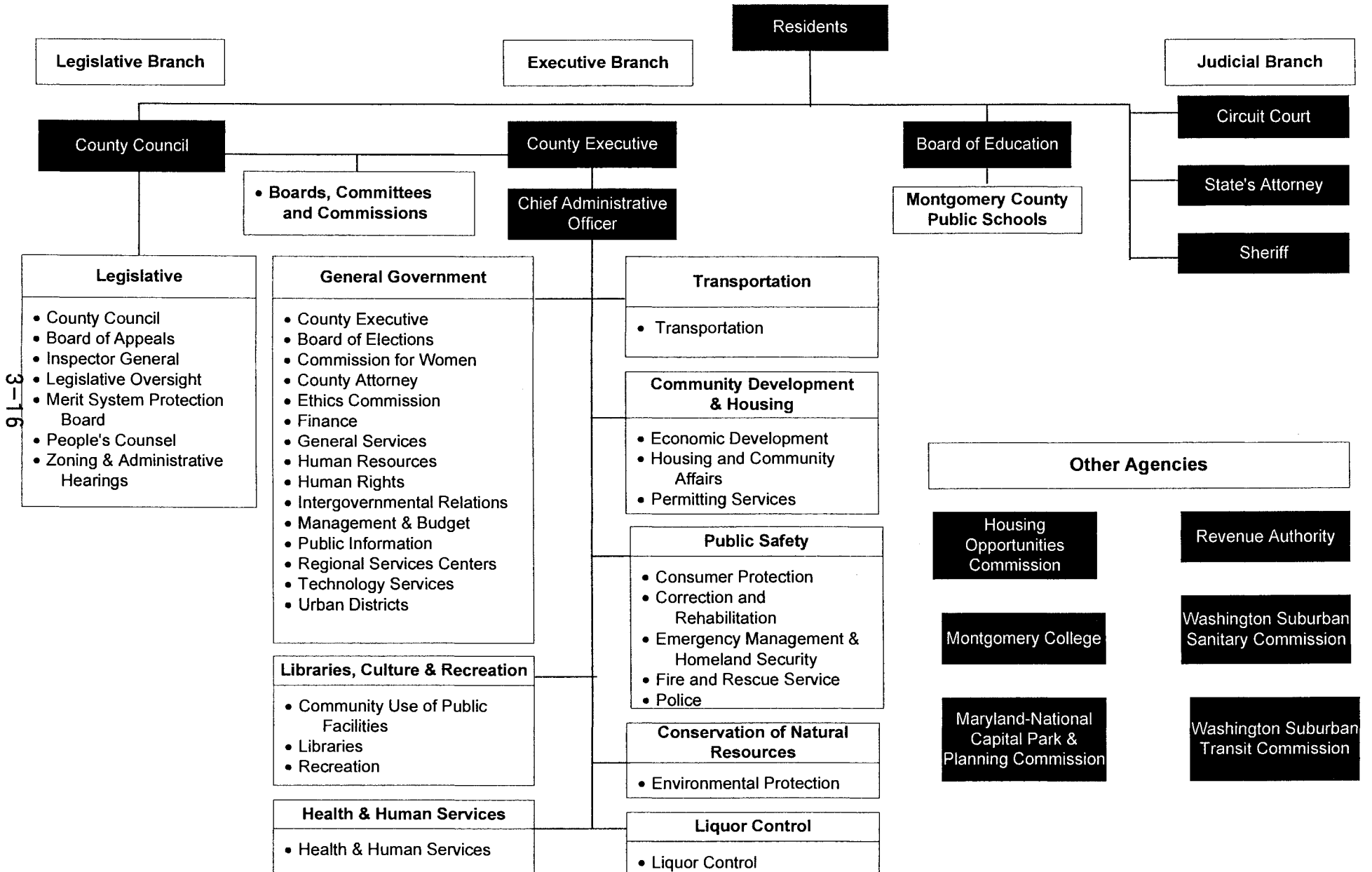

3-16