



Operating Budget Process

INTRODUCTION

The Montgomery County Charter, approved by the voters in 1968 and implemented in 1970, provides for a County Council/Executive form of government. Under this form of government, the Executive develops and recommends budget proposals; the Council then authorizes expenditures and sets property tax rates. The Charter also provides for an annual six-year Public Services Program (PSP), Operating Budget, and Capital Budget and a biennial six-year Capital Improvements Program (CIP). These budgets and related fiscal and programmatic plans provide the basis for understanding, coordinating, and controlling County government programs and expenditures.

This section provides a brief introduction and refers to the legal requirements for the annual budget process, and includes descriptions of government structure and government accounting methods and funds.

THE BUDGET PROCESS

Fiscal Year

The 12-month period used to account for revenues and expenditures in Montgomery County commences on July 1 of each year and ends on June 30 of the following year. A Budget Process Flow Chart timeline appears later in this section, which displays the relationships between the Capital Budget/Capital Improvements Program (CIP), Operating Budget/Public Services Program (PSP), and Growth Policy processes across the year.

Operating and Capital Budgets

The complete County Executive's Recommended Budget includes the CIP, published by January 15 in even-numbered calendar years; the Capital Budget, published annually by January 15; and this document, the Operating Budget and PSP, published annually by March 15.

Further information about the PSP can be found later in this section. For further information about the CIP/Capital Budget, please refer to the Capital Improvements Program (CIP) section of this document.

Spending Affordability Process

The Spending Affordability process for the Operating Budget is required by Section 305 of the County Charter and Chapter 20 of the Montgomery County Code.

The County Council must set Spending Affordability Guidelines (SAG) for the Operating Budget by the second Tuesday in February after a public hearing. The guidelines must specify a ceiling on funding from property tax revenues and a ceiling on the aggregate operating budget. In adopting SAG, the Council considers the condition of the economy, the level of economic activity in the County, personal income levels, and the impact of economic and population growth on projected revenues among other relevant factors.

Along with the guidelines, the Council also adopts recommended spending allocations for the tax-supported budgets of County Government, the Board of Education, Montgomery College, the Maryland-National Capital Park and Planning Commission, debt service, and current revenue funding for the CIP.

By March 31, each agency and the Executive must also specify how, if necessary, they would reduce the budget request to reach the Council allocation.

The Charter requires the Council to approve the Operating and Capital Budgets by June 1. An aggregate operating budget that exceeds the aggregate operating budget for the preceding fiscal year by a percentage increase greater than the annual average increase of the Consumer Price Index for all urban consumers (CPI-U) in the Washington-Baltimore Metropolitan area (or any successor index) for the 12 months preceding December first of each year requires the affirmative vote of six Councilmembers. An aggregate operating budget which exceeds the SAG ceiling on the aggregate operating budget then in effect requires the affirmative vote of seven Councilmembers. The Council approved spending affordability guidelines and allocations are displayed in the Spending Affordability Comparison chart at the end of this chapter.

Limits on Revenues

Section 305 of the County Charter includes a limit on the annual increase in property tax revenues. An amendment approved in 2008 requires that real property tax revenues, with the exception of new construction and property whose zoning or use has changed, may not increase by more than the prior year revenues plus the percentage increase in the Washington-Baltimore Metropolitan area CPI-U unless there is an unanimous vote of nine Councilmembers to exceed that limit.

Operating Budget Preparation and Executive Review

Requirements for submission of, and action on, County budgets are contained in Article 3 of the County Charter. Departments and agencies prepare budget requests within guidelines established by the Executive (for the departments) and by law (for other agencies of government). These are submitted on scheduled dates for analysis by the Office of Management and Budget (OMB) and are reviewed by the Executive during the period January-March. The Executive recommends a budget which balances all agency expenditures with projected revenues to the Council by March 15.

Public Hearings

Citizen participation is essential to a fair and effective budget process. Many citizens and advisory groups work with specific departments to ensure that their concerns are addressed in departmental requests. The County Charter requires the Council to hold a public hearing not earlier than 21 days after receipt of the recommended operating budget from the Executive.

Public hearings are advertised in County newspapers. Speakers must register with the Council Office to testify at the public hearings. Persons wishing to testify should call the Council Office to register 240.777.7803. If it is not possible to testify in person at the hearings, written testimony is acceptable and encouraged. For further information and dates of the Council's public hearings on the County Executive's Recommended Operating Budget, contact the Legislative Information Office at 240.777.7910. Hearings are held in the Council Hearing Room of the Stella B. Werner Council Office Building, unless otherwise specified.

Council Budget Review

After receiving input from the public, the Council begins its review of the Executive's Recommended Operating Budget. Each agency budget is reviewed by a designated Council committee. Agency and Office of Management and Budget (OMB) representatives meet with these committees to provide information and clarification concerning the recommended budget and agency programs. In April and May, the full Council meets in regular sessions, reviews the recommendations of its committees, and takes final action on each agency budget.

Operating and Capital Budget Approval

The Charter requires that the Council approve and make appropriations annually for the operating and capital budgets by June 1. In even-numbered calendar years, the Council also approves a six-year Capital Improvements Program. Prior to June 30, the Council must set the property tax levies necessary to finance the budgets. Other sections of the Charter provide for Executive veto or reduction of items in the budget approved by the Council. The Charter prohibits expenditure of County funds in excess of available unencumbered appropriations.

Amending the Approved Operating and Capital Budgets

The Operating and Capital Budgets may be amended at any time after adoption by the Council.

Supplemental appropriations are recommended by the County Executive, specify the source of funds to finance the additional expenditures, and may occur any time after July 1 of the fiscal year. A supplemental appropriation that would comply with, avail the County of, or put into effect a grant or a Federal, State, or County law or regulation, or one that is approved after January 1 of any fiscal year, requires an affirmative vote of five Councilmembers. A supplemental appropriation for any other purpose that is approved before January 1 of any fiscal year requires an affirmative vote of six Councilmembers. The Executive may disapprove or reduce a supplemental appropriation, and the Council may re-approve the appropriation, as if it were an item in the annual budget.

Special appropriations are recommended by either the County Executive or County Council, specify the source of funds to finance the additional expenditures, and are used when it is necessary to meet an unforeseen disaster or other emergency or to act without delay in the public interest. The Council may approve a special appropriation after public notice by news release, and each special appropriation must be approved by six members of Council.

Transfers of appropriation which do not exceed ten percent of the original appropriation, may be accomplished by either: the County Executive, for transfers within or between divisions of the same department; or by the County Council, for transfers between departments, boards or commissions, or to new accounts.

Public Services Program (PSP)

Projections of County revenues relative to anticipated expenditure requirements constrain the level of public services affordable. The Public Services Program (PSP) looks to balance the growth in revenues, based on the County Executive's current revenue and fiscal policies, with the pressures affecting the future cost of services. The Charter (Section 302) requires the County Executive to submit an annual comprehensive six-year program for public services and fiscal policy. The PSP includes:

- a statement of program objectives;
- recommended levels of public service;
- an estimate of costs over the six-year period;
- a statement of revenue sources;
- estimated impact of the PSP on County revenues and the capital budget; and
- projected revenues and expenditures for all functions of the County government.

The Charter requires that the annual budget, submitted in conjunction with the PSP, be consistent with the six-year program.

Recommended levels of public service can be seen in the six-year projections of expenditures for each special fund. Expenditures are projected based on major known commitments. Actual costs, over time, are the result of several variables, including collective bargaining, government policy, and objectives of fairness between agencies and employee groups.

An estimate of the impact of the Public Services Program on County revenues is included, where applicable, in the program descriptions or in the fiscal data for the department or agency. Impact on the program of the Capital Budget is included,

where applicable, in the program descriptions; Future Fiscal Impacts; or in facility plans, when the program or service delivery will require expanded, additional, or replacement facilities that are scheduled in the Capital Improvements Program (CIP).

RESULTS BASED BUDGETING

A responsive and accountable County government is one of the Executive's priorities. As a way to achieve that goal, the County Executive has adopted a results based approach to budgeting. This technique starts with the ends that are desired, in terms of program outcomes described using quantifiable results, and works backward to the means, or resources, that are required to achieve those results.

When allocating resources under this approach, increases or decreases in budgeted resources must be evaluated and justified by projected changes in measurable outcomes supported by research or other evidence and must be consistent with predefined objectives or results areas. The department chapters that follow in this recommended budget show the results areas and the performance measures that have been established for each department.

APPENDICES TO THIS SECTION

Government Structure

This section shows the organizational entities that compose Montgomery County.

Government Accounting Methods and Funds

This section describes the funds and accounting mechanisms used to manage County resources.

Spending Affordability Comparison

This section includes the Council approved spending affordability guidelines and allocations.

Montgomery County Functional Organization Chart

This chart displays the organizational structure of departments and agencies for the County government.

Montgomery County Government Public Documents

This table contains a list of all budget-related public documents, including the approximate dates of publication and how they may be obtained.

Budget Process Flow Chart

This chart follows the Capital/CIP and Operating/PSP budget process from the start of the process in August to the final approval of the budgets in June for all agencies.

Montgomery County Map

This map displays the major roads in the County, and the County's location in the State of Maryland.

GOVERNMENT STRUCTURE

Montgomery County includes several organizational components and joint ventures, including:

Montgomery County Government (MCG), which includes Executive departments (such as Recreation, Environmental Protection, and Police) and offices (such as County Attorney), the County Council's legislative offices and boards, the Circuit Court, and judicial offices;

Montgomery County Public Schools (MCPS), under the authority of the Board of Education (BOE);

Montgomery College (MC), the County's two-year community college, under the authority of its Board of Trustees;

Maryland-National Capital Park and Planning Commission (M-NCPPC), a bi-county agency which manages public parkland and provides land use planning, with administration shared with Prince George's County;

Washington Suburban Sanitary Commission (WSSC), a bi-county agency which provides water and sewer service to Montgomery and Prince George's Counties;

Housing Opportunities Commission (HOC), the County's public housing authority; and

Montgomery County Revenue Authority, a public corporation for self-supporting enterprises of benefit to the County.

Bethesda Urban Partnership, a not-for-profit organization, executes service contracts for the benefit of one of the Primary Government's special taxing districts (Bethesda Urban District).

Along with M-NCPPC and WSSC, the following organizations are also considered joint ventures of the County: Washington Suburban Transit Commission (WSTC), Washington Metropolitan Area Transit Authority (WMATA), Metropolitan Washington Council of Governments (COG), and Northeast Maryland Waste Disposal Authority (NEMWDA).

An organization chart is included at the end of this section to assist the reader to understand the relationship between the Executive's Recommended Budget and the various agencies of government in Montgomery County.

GOVERNMENT ACCOUNTING METHODS AND FUNDS

The accounting records of Montgomery County government for tax supported funds are maintained on a modified accrual basis, with revenues being recorded only when available and measurable, and expenditures recorded when goods or services are received and liabilities incurred. Accounting records for proprietary and trust funds are maintained on the accrual basis, with all revenues recorded when earned and expenses recorded at the time liabilities are incurred, without regard to receipt or payment of cash. The principal funds of the County government are:

Tax Supported Funds	Non-Tax Supported Funds:
MCPS: Current Fund	MCPS: Grant, Food Service, and other Enterprise Funds
Montgomery College: Current and Emergency Repair Funds	Montgomery College: Grant, Continuing Education, Cable Television, and Auxiliary Funds
M-NCPPC: Administration, Parks, and Advance Land Aquisition Revolving Fund (ALARF) Funds	M-NCPPC: Grant, Enterprise, Property Management, and Special Revenue Funds
Montgomery County Government: General, Recreation, Urban Districts, Noise Abatement Districts, Mass Transit, Fire Tax District, and Economic Development Funds	Montgomery County Government: Grant, Solid Waste (Collection and Disposal), Vacuum Leaf Collection, Parking Districts, Cable Television, Liquor Control, Permitting Services, Community Use of Public Facilities, Water Quality Protection, and Montgomery Housing Initiative Funds

Tax Supported Funds	Non-Tax Supported Funds:
Debt Service associated with General and Special Tax Supported Funds	Debt Service associated with Non-Tax Supported Funds
Current Revenue to the CIP (including Pay As You Go (PAYGO))	HOC and Revenue Authority
Revenue Stabilization Fund contributions	WSSC

General Fund

The General Fund is the principal operating fund for the County government. It is used to account for all financial resources except those required by law, County policy, and generally accepted accounting principles to be accounted for in another fund.

Special Revenue Funds

Special revenue funds account for activities supported, in part, by special taxes on specific geographical areas, user charges or service fees from those benefiting from special services, or a combination of both. Special revenue funds have been established as follows:

TAX SUPPORTED SPECIAL REVENUE FUNDS

Economic Development Fund: accounts for grant, loan, and loan repayment activity to assist in attracting and retaining business operations in Montgomery County.

Fire Tax District Fund: accounts for fiscal activity related to the receipt of dedicated property taxes for fire service and the provision of fire and rescue services throughout Montgomery County.

Mass Transit Facilities Fund: accounts for fiscal activity related to planning, developing, and operating County government transit programs.

Noise Abatement District Funds: account for the receipt and use of resources to pay debt service on bonds issued to finance construction of noise abatement barriers at specific locations along interstate highways.

Recreation Fund: accounts for the receipt and use of recreation taxes, program fees, and other resources for the County's Recreation District.

Revenue Stabilization Fund: accounts for the accumulation of resources during periods of economic growth and prosperity, when revenue collections exceed estimates. Funds may then be drawn upon during periods of economic slowdown, when collections fall short of revenue estimates.

Urban District Funds: account for the receipt and use of resources related to the maintenance and enhancement of the Bethesda, Silver Spring, and Wheaton business districts.

NON-TAX SUPPORTED SPECIAL REVENUE FUNDS

Cable TV Fund: accounts for fiscal activity related to the receipt and use of grants from the County's cable television franchisees (Comcast, RCN, and Verizon) and receipts due to the County over several years as the result of the transfer of ownership of the cable system from the original franchisee to the current owner. Franchise fee payments from the cable company are deposited in this Fund and used to defray costs of cable-related activities of various departments and agencies of County government and to pay municipal co-franchisor expenses as required by County law. Income in excess of the Cable fund's operating requirements may be transferred to the General Fund and used to finance general government

operations.

Grants Fund: accounts for the Federal and State grant-funded activities of the tax supported General Fund and Special Revenue Funds.

Montgomery Housing Initiative Fund: accounts for fiscal activity related to financing, supplementing, and constructing affordable residential facilities for eligible participants.

Water Quality Protection Fund: accounts for fiscal activity related to maintenance of certain stormwater management facilities, a related loan program to help property owners upgrade such facilities, and a water quality protection charge on certain properties.

Internal Service Funds

These funds are used for the financing of goods and services provided by one department or agency to other departments and agencies of the County government on a cost-reimbursement basis. The following are the Internal Service Funds used by Montgomery County government:

Central Duplicating Fund: accounts for fiscal activity related to printing and postage services provided to the user agencies, including assessments to departments for mail services and "chargeback" transfers from departments using printing and photocopy services.

Employee Health Benefits Self Insurance Fund: accounts for fiscal activity related to health, life, vision, dental, and long-term disability insurance needs of the participating governmental agencies.

Motor Pool Fund: accounts for operating revenues and expenses related to the automotive and other motorized equipment needs of the user departments of Montgomery County.

Liability and Property Coverage Self-Insurance Fund: accounts for fiscal activity related to liability, property, and workers' compensation needs of participating governmental agencies.

Debt Service Fund

The Debt Service Fund accounts for fiscal activity related to the payment of principal, interest, and related costs of general obligation debt, long-term leases, and short-term financing.

Capital Projects Fund

The Capital Projects Fund accounts for fiscal activity related to the acquisition or construction of major capital facilities.

Permanent Funds

Permanent funds are used to account for resources that are legally restricted to the extent that only earnings, and not principal, may be used for purposes that support the reporting government's programs -- that is, for the benefit of the government or its citizenry.

Enterprise Funds

Enterprise funds account for activities: 1) that are financed with debt secured solely by a pledge of the net revenues from the

fees and charges of the activity; 2) where the pricing policies of the activity establish fees and charges designed to recover its costs, including capital costs such as depreciation or debt service; or 3) in certain situations, where a fee is charged to users for goods and services. The following are the Enterprise Funds used by Montgomery County government:

Community Use of Public Facilities Fund: accounts for fiscal activity related to making public space, such as schools, available to community organizations, commercial users, and others during non-school hours.

Liquor Fund: the Montgomery County Department of Liquor Control has a monopoly on all wholesale sales of alcoholic beverages and retail sales of distilled spirits in the County. This fund accounts for the operations of the County government's liquor retail stores, the liquor warehouse, and the administration of the Department of Liquor Control. Income in excess of the Department's operating requirements is transferred to the General Fund and used to finance general government operations.

Parking Lot District Funds: account for fiscal activity related to serving parking needs of those who work and shop in four central business/parking lot districts (Silver Spring, Bethesda, Wheaton, and Montgomery Hills).

Permitting Services Fund: accounts for all fiscal activity related to the collection and use of building permit fees and other charges related to the development process.

Solid Waste Fund: accounts for fiscal activity of all solid waste disposal operations, including recycling, for the County; County contracted refuse collection within the Solid Waste Collection District.

Vacuum Leaf Collection Fund: provides two vacuum leaf collections to residents in the down county during the late fall/winter months.

Fiduciary Funds

Fiduciary funds account for assets held by the County in a trustee capacity or as an agent for individual private organizations, other governmental units, and/or other funds. The following are the Fiduciary Funds used by Montgomery County government:

Agency Funds: account for the administration of assets that are received by the County incidentally in connection with the discharge of its responsibilities. The County uses these funds for special assessment development districts and holding property tax payment.

Private-Purpose Trust Funds: include trust arrangements under which principal and income benefit individuals, private organizations, or other governments. Also included in these funds is the endowment fund for the Strathmore Hall Foundation, to which the County has contributed and which provides funds for operation of the facility.

Investment Trust Fund: accounts for the external portion of the County's external investment pool that belongs to legally separate entities and non-component units.

Pension and Other Employee Benefit Trust Funds: account for resources that are required to be held in trust for the members and beneficiaries of such pension and employee benefit plans.

Other Special Revenue Funds

Other special revenue funds do not have appropriations within the Operating Budget; however, their fund balances are re-appropriated as part of the miscellaneous provisions of the appropriation resolution.

Drug Enforcement Forfeitures Fund: accounts for the receipt of cash and other property forfeited to the County during drug enforcement operations. Fund resources are used for law enforcement and drug education programs.

New Home Warranty Security Fund: accounts for the collection of warranty fees from builders and the payment of homeowner claims against builders.

Rehabilitation Loan Fund: a revolving loan fund, established with General Fund money, to help income-eligible homeowners finance rehabilitation required to make their homes conform to applicable Montgomery County Code requirements.

Restricted Donations Fund: accounts for donations and contributions received by the County that are restricted for use in specific County programs.

SPENDING AFFORDABILITY COMPARISON

(Dollars in Millions)

A CATEGORY	B FY17 CC Approved 5-26-16	C FY17 Estimate 3-14-17	D FY18 CC SAG 2-14-17	E FY18 CE Recommended 3-14-17	F FY18 % Chg App / Rec	G FY18 \$ Chg App / Rec
Property Tax	1,738.7	1,737.6		1,767.3	1.6%	28.6
Income Tax	1,487.6	1,486.4		1,557.9	4.7%	70.3
Transfer/Recordation Tax	165.8	179.8		170.4	2.8%	4.6
Other Tax	278.3	277.9		282.5	1.5%	4.1
General State/Fed/Other Aid	822.6	828.4		843.0	2.5%	20.4
All Other Revenue	205.1	206.4		210.8	2.8%	5.7
Revenues	4,698.1	4,716.6		4,831.9	2.8%	133.8
Net Transfers In (Out)	14.0	12.5		30.5	117.8%	16.5
Set Aside: Potential Supplementals	-	-		-	n/a	-
Set Aside: Other Claims	(0.1)	0.0		-	-100.0%	0.1
Beginning Reserve: Total	439.0	453.8		477.6	8.8%	38.7
Revenue Stabilization Fund	254.7	254.4		280.4	10.1%	25.7
Reserve: Undesignated	184.2	199.4		197.2	7.1%	13.0
TOTAL RESOURCES	5,151.0	5,182.9		5,340.1	3.7%	189.1
APPROPRIATIONS						
Capital Budget:						
CIP Current Revenue	(45.8)	(57.5)	(80.8)	(68.3)	49.2%	(22.5)
CIP PAYGO	(34.0)	(34.0)	(34.0)	(34.0)	0.0%	-
Operating Budget:						
MCPS	(2,311.6)	(2,294.2)	(2,334.1)	(2,366.6)	2.4%	(55.0)
College, Total	(261.6)	(255.2)		(260.6)	-0.4%	1.0
Less College Tuition	82.6	78.1		80.3	-2.7%	(2.2)
College, Net	(179.0)	(177.2)	(177.2)	(180.2)	0.7%	(1.2)
County Government	(1,453.8)	(1,455.5)	(1,478.2)	(1,498.7)	3.1%	(44.9)
M-NCPPC	(118.8)	(118.8)	(120.8)	(122.2)	2.9%	(3.4)
Retiree Health Insurance Prefunding	(109.9)	(109.9)	(106.7)	(122.2)	11.2%	(12.3)
Other: (Unallocated) / GAP	-	-		-	n/a	0.0
Total Operating Budget:	(4,255.6)	(4,233.6)		(4,370.2)	2.7%	(114.6)
Debt Service:						
All County Debt Service	(352.4)	(349.6)	(402.0)	(369.9)	5.0%	(17.5)
M-NCPPC Debt Service	(4.9)	(4.9)	-	(5.7)	15.1%	(0.7)
MCG Long Term Leases (b)	(30.9)	(25.6)	-	(24.4)	-21.0%	6.5
TOTAL APPROPRIATIONS (incl. Capital, Operating & Debt Service)	(4,723.6)	(4,705.3)	(4,733.8)	(4,872.5)	3.2%	(148.9)
Aggregate Operating Budget (excludes College tuition)	(4,641.0)	(4,627.2)	(4,733.8)	(4,792.2)	3.3%	(151.1)
Revenue Stabilization Fund (new \$s)	(25.6)	(26.0)		(27.7)	8.1%	(2.1)
Ending Reserve: Total	427.4	477.6		467.6	9.4%	40.2
Revenue Stabilization Fund	280.3	280.4		308.1	9.9%	27.7
Ending Reserve: Designated	-	-		-	n/a	-
Ending Reserve: Undesignated	147.1	197.2		159.5	8.4%	12.4
Maximum AOB without 6 votes (Prior Year AOB + inflation as shown)	(4,446.3)			(4,693.9)		
	0.32%			1.14%		

a) Based on latest revenue and expenditure estimates as prepared by Department of Finance and OMB.

b) Long term leases of Montgomery County Government are considered equivalent to debt service.

Montgomery County, Maryland Functional Organization Chart

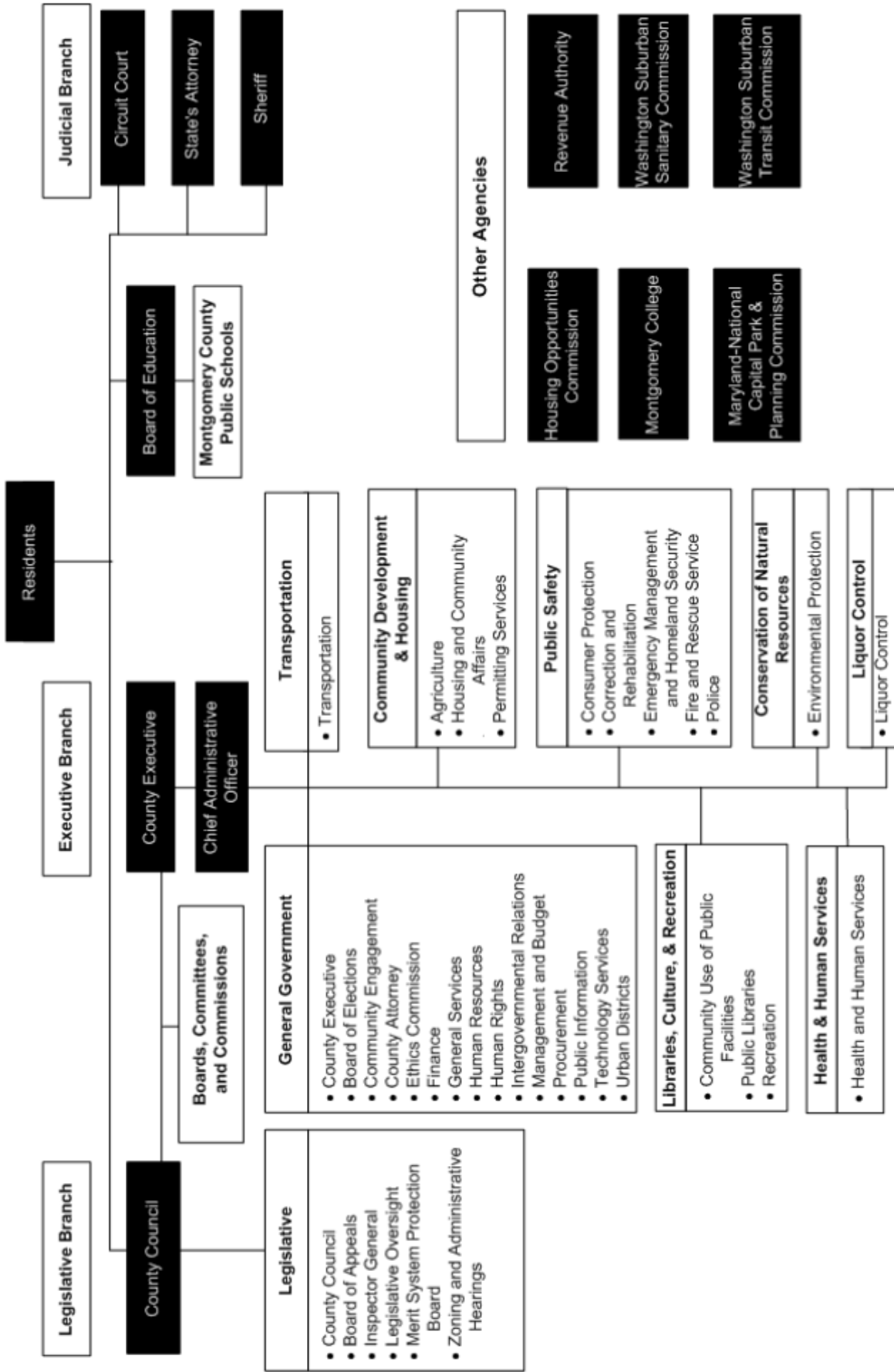

MONTGOMERY COUNTY PUBLIC DOCUMENTS:
ANNUAL BUDGETS, GROWTH POLICY, AND OTHER SOURCES OF INFORMATION

DATE	ITEM	AVAILABILITY
January 15th (even calendar years)	COUNTY EXECUTIVE'S RECOMMENDED CAPITAL BUDGET AND CAPITAL IMPROVEMENTS PROGRAM (CIP) <i>County Executive's Transmittal; Introductory Sections; County Government Departments; HOC; Revenue Authority; MCPS; Montgomery College; M-NCPPC; WSSC</i>	www.montgomerycountymd.gov/omb Reference copies at public libraries Office of Management and Budget (240.777.2800) (for purchase on limited basis)
January 15th (odd calendar years)	COUNTY EXECUTIVE'S RECOMMENDED CAPITAL BUDGET AND AMENDMENTS TO (PRIOR YEAR) CAPITAL IMPROVEMENTS PROGRAM <i>County Executive's Transmittal; Capital Budget; Amendments</i>	www.montgomerycountymd.gov/omb
March 15th	COUNTY EXECUTIVE'S RECOMMENDED OPERATING BUDGET AND PUBLIC SERVICES PROGRAM <i>County Executive's Transmittal; Financial Summaries; Legislative, Judicial, Executive Branch Departments; MCPS; Montgomery College; M-NCPPC; WSSC</i>	www.montgomerycountymd.gov/omb Reference copies at public libraries Office of Management and Budget (240.777.2800) (for purchase on limited basis)
March 31st	FISCAL PLAN <i>Contains estimates of costs and revenues over the six-year planning period for all Montgomery County special and enterprise funds and many Agency funds.</i>	www.montgomerycountymd.gov/omb Office of Management and Budget (240.777.2800)
June 15th (odd calendar years)	PLANNING BOARD RECOMMENDED GROWTH POLICY - STAFF DRAFT	Reference copies from M-NCPPC (301.495.4610)
mid-July (even calendar years)	APPROVED OPERATING AND CAPITAL BUDGETS, AND APPROVED CAPITAL IMPROVEMENTS PROGRAM <i>PSP and CIP Appropriation and Approval Resolutions; Operating Budget, CIP and Capital Budget Summaries; Project Description Forms for County Government Programs, HOC, Revenue Authority, MCPS, Montgomery College, M-NCPPC, and WSSC</i>	www.montgomerycountymd.gov/omb Reference copies at public libraries Office of Management and Budget (240.777.2800) (for purchase on limited basis)
mid-July (odd calendar years)	APPROVED OPERATING AND CAPITAL BUDGETS, AND APPROVED AMENDMENTS TO THE CAPITAL IMPROVEMENTS PROGRAM <i>PSP and CIP Appropriation and Approval Resolutions; Operating and Capital Budget Summaries; and selected Project Description Forms for County Government Programs, HOC, Revenue Authority, MCPS, Montgomery College, M-NCPPC, and WSSC</i>	Reference copies at public libraries Office of Management and Budget www.montgomerycountymd.gov/omb (240.777.2800) (for purchase on limited basis)
August 1 (odd calendar years)	PLANNING BOARD RECOMMENDED GROWTH POLICY - FINAL DRAFT	Reference copies from M-NCPPC (301.495.4610)

MONTGOMERY COUNTY PUBLIC DOCUMENTS:
ANNUAL BUDGETS, GROWTH POLICY, AND OTHER SOURCES OF INFORMATION

DATE	ITEM	AVAILABILITY
Late December	COMPREHENSIVE ANNUAL FINANCIAL REPORT	Reference copies at public libraries: Department of Finance (240.777.8822)

DATE	ITEM	AVAILABILITY
		www.montgomerycountymd.gov/finance (on limited basis)
Quarterly	ECONOMIC INDICATORS	Department of Finance (240.777.8866) www.montgomerycountymd.gov/finance
Monthly (To update the Economic Indicators Report)	ECONOMIC UPDATE	Department of Finance (240.777.8866) www.montgomerycountymd.gov/finance
Annually	ANNUAL INFORMATION STATEMENT	Department of Finance (240.777.8822) www.montgomerycountymd.gov/finance (on limited basis)
Available throughout the year	MONTGOMERY COUNTY HISTORICAL SOCIETY INFORMATION	Montgomery County Historical Society (301.340.2825) www.montgomeryhistory.org
Available throughout the year	MONTGOMERY COUNTY DEMOGRAPHIC INFORMATION	Maryland-National Capital Park and Planning Commission: Montgomery County Planning Board(301.495.4600) www.montgomeryplanning.org/research

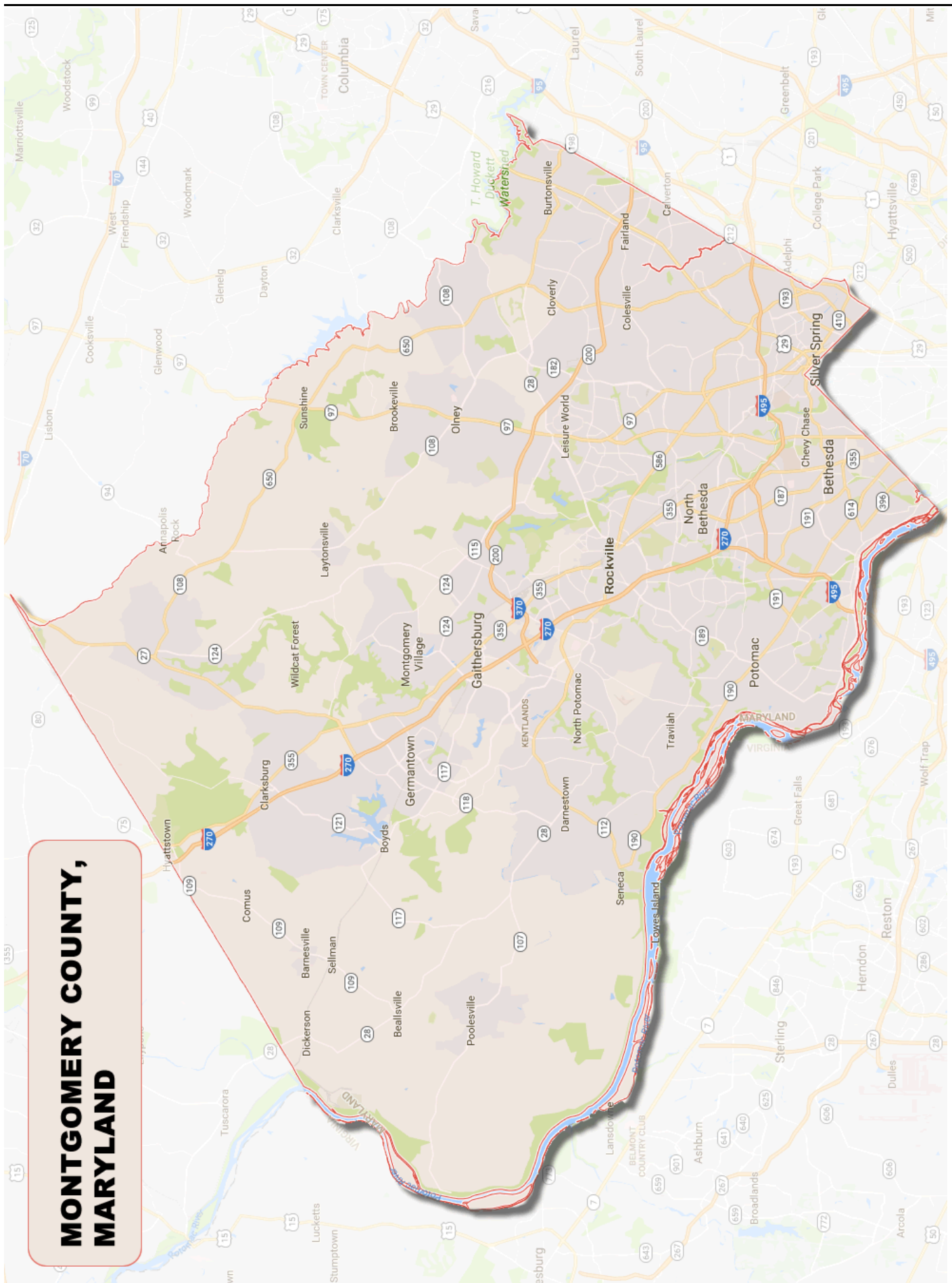

BUDGET PROCESS FLOW CHART

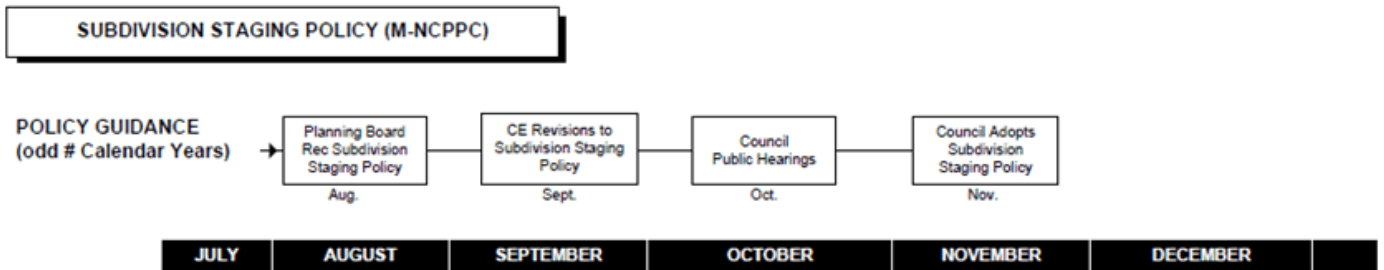
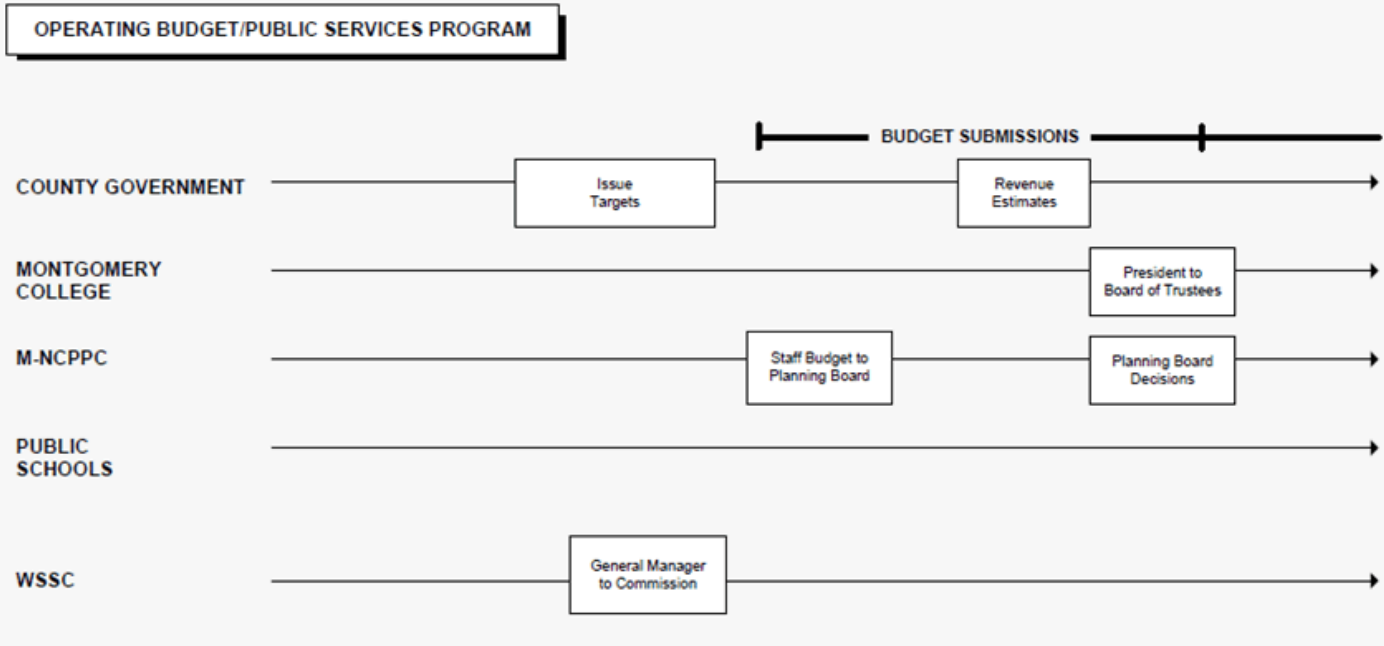
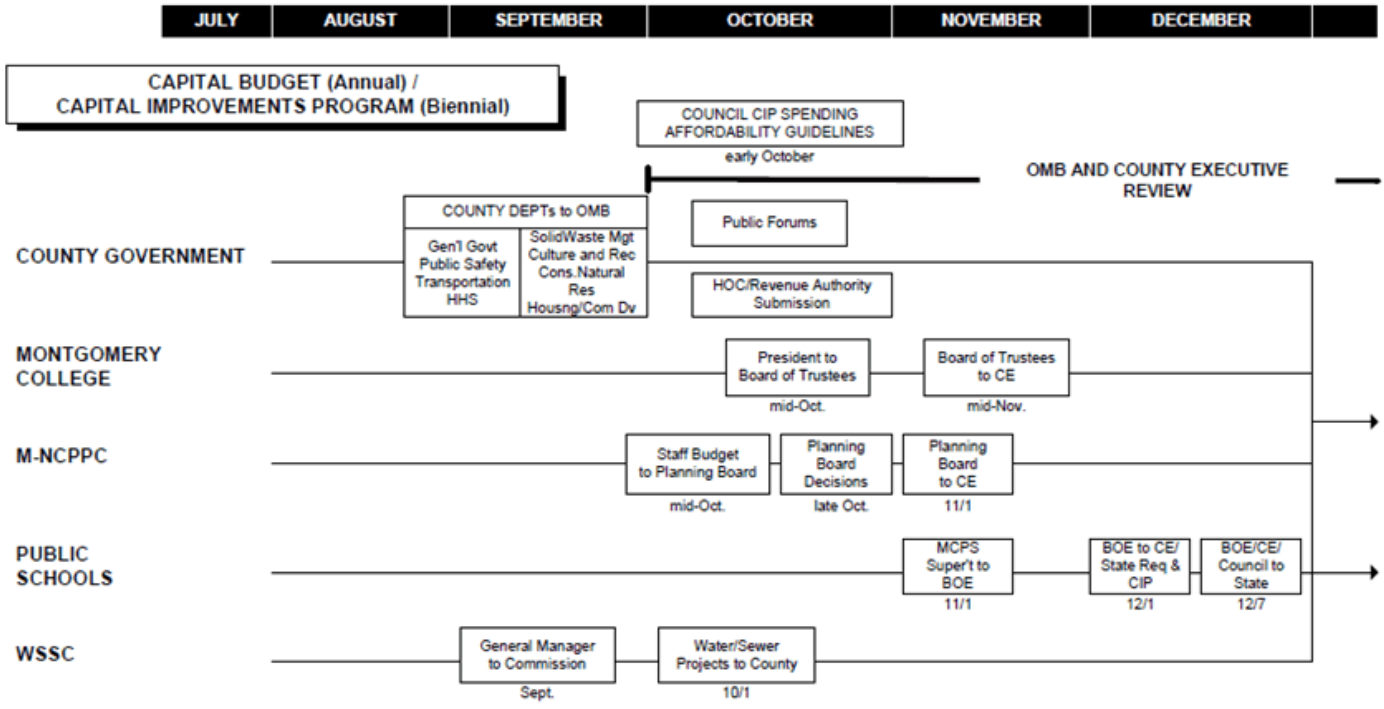

JANUARY	FEBRUARY	MARCH	APRIL	MAY	JUNE	JULY
---------	----------	-------	-------	-----	------	------

Council Revisits
CIP/SAG

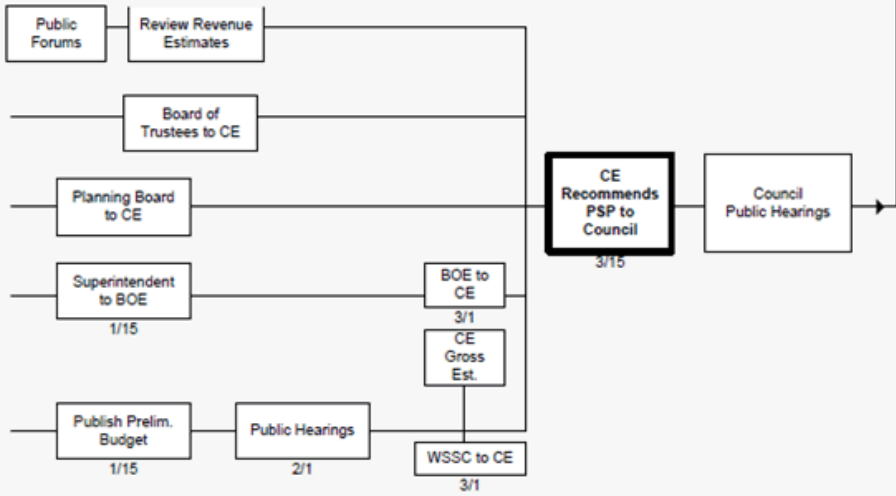
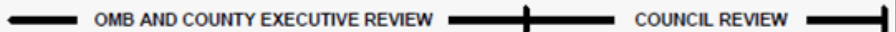
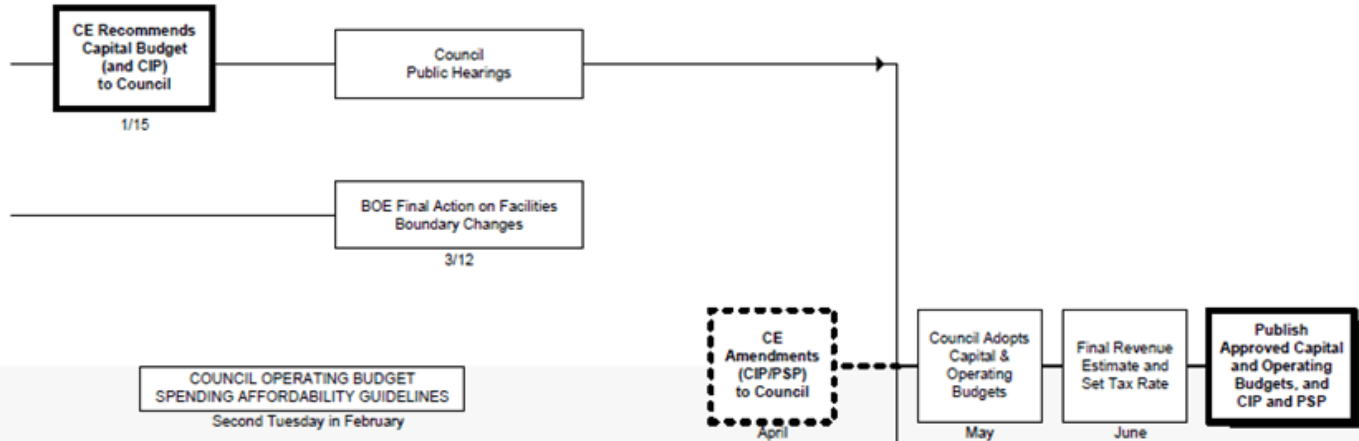
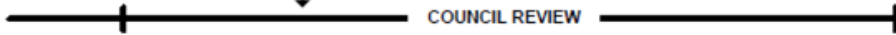

JANUARY	FEBRUARY	MARCH	APRIL	MAY	JUNE	JULY
---------	----------	-------	-------	-----	------	------

THIS PAGE INTENTIONALLY LEFT BLANK