



Ferno Customer Relations

For ordering assistance or general information:

CANADA AND THE U.S.A.

| | |
|-----------------------|--|
| Telephone (Toll-free) | 1.877.733.0911 |
| Telephone | 1.937.382.1451 |
| Fax (Toll-free) | 1.888.388.1349 |
| Fax | 1.937.382.1191 |
| Internet | www.ferno.com |

ALL OTHER LOCATIONS

For assistance or information, please contact your Ferno distributor. If you do not have a Ferno distributor, please contact Ferno Customer Relations:

Ferno-Washington, Inc., 70 Weil Way
Wilmington, Ohio 45177-9371, U.S.A.

| | |
|-----------|--|
| Telephone | Country Code +1.937.382.1451 |
| Fax | Country Code +1.937.382.6569 |
| Internet | www.ferno.com |

FOR iNjX SUPPORT

Contact us at inxsupport@ferno.com

Disclaimer

This manual contains general instructions for the use, operation and care of this product. The instructions are not all-inclusive. Safe and proper use of this product is solely at the discretion of the user. Safety information is included as a service to the user. All other safety measures taken by the user should be within and under consideration of applicable regulations and local protocol. Training on the proper use of this product must be provided before using this product in an actual situation.

Retain this manual for future reference. Include it with the product in the event of transfer to new users. Additional free copies are available upon request from Customer Relations.

Proprietary Notice

The information disclosed in this manual is the property of Ferno-Washington, Inc., Wilmington, Ohio, USA. Ferno-Washington, Inc. reserves all intellectual property rights, proprietary design rights, manufacturing rights, reproduction use rights, and sales use rights thereto, and to any article disclosed therein except to the extent those rights are expressly granted to others or where not applicable to vendor proprietary parts.

Limited Warranty Statement

The products sold by Ferno are covered by a limited warranty, which is printed on all Ferno invoices. The complete terms and conditions of the limited warranty, and the limitations of liability and disclaimers, are also available upon request by calling Ferno at 1.800.733.3766 or 1.937.382.1451.



Ferno-Washington, Inc.
70 Weil Way
Wilmington, Ohio 45177-9371 U.S.A.
1.937.382.1451

EC REP

Ferno (UK) Limited
Stubs Beck Lane, Cleckheaton
West Yorkshire BD19 4TZ, United Kingdom
44 (0) 1274 851999



Serial Number _____

Location: Patient-left main frame, under battery cover

Enhanced Manual



When this symbol appears in the manual or on the iNjX, scan the QR code (using a smart-phone) or click (in the electronic manual) for online information and video content (requires internet access). www.fernoems.com/inx



Read this manual and retain for future reference. A training DVD is also provided. To request additional manuals or DVDs, contact Ferno.

Tip

Battery Recycling

In the U.S.A. and Canada, contact Call2Recycle toll-free to locate a local place to responsibly dispose of a Ferno rechargeable battery. See the contact information below.

Or, contact the government of your state, territory or country for recycling information. See "Recycling Notice" on page 55.



iNjX 36 VDC
Lithium-iron phosphate
(LiFePO₄)

TABLE OF CONTENTS

| Section | Page | Section | Page |
|--|-----------|---|---------------|
| Ferno Customer Relations | 2 | 5 - Using the iNjX | 32 |
| 1 - Safety Information | 4 | 5.1 Before Placing the iNjX in Service | 32 |
| 1.1 Warning | 4 | 5.2 General Guidelines for Use | 32 |
| 1.2 Important | 5 | 5.3 Status Indicators and Audible Alarm | 32 |
| 1.3 Tip | 5 | 5.4 Powered Extending/Retracting | 33 |
| 1.4 Bloodborne Disease Notice | 5 | 5.5 Transferring the Patient | 34 |
| 1.5 Fastening System Compatibility | 5 | 5.6 Transferring the Patient: Chair Position | 35 |
| 1.6 Symbol Glossary | 5 | 5.7 Rolling the iNjX | 36 |
| 1.7 Safety and Instruction Labels | 6 | 5.8 One Operator, Empty iNjX | 37 |
| 1.8 Compliance: USA Standard SAE J3027 | 6 | 5.9 Loading the iNjX | 38 |
| 1.9 Compliance: Worldwide | 7 | 5.10 Unloading the iNjX | 40 |
| 2 - Operator Focus | 8 | 5.11 Direct Power Modes | 42 |
| 2.1 Operator Training | 8 | 5.12 Direct Power: Both Legs | 43 |
| 2.2 Operator Height and Strength | 8 | 5.13 Direct Power: Loading-End Legs | 43 |
| 2.3 Daily Operator Duties | 9 | 5.14 Direct Power: Control-End Legs | 43 |
| 2.4 No-Lift Loading/Unloading | 9 | 5.15 Non-Powered Operation: Extending and Retracting | 44 |
| 2.5 Controlling the Load | 9 | 5.16 Non-Powered Operation: Loading | 46 |
| 2.6 Using Additional Help | 10 | 5.17 Non-Powered Operation: Unloading | 47 |
| 2.7 Terms | 11 | 6 - Maintenance | 48 |
| 3 - iNjX Overview | 12 | 6.1 Maintenance Schedule | 48 |
| 3.1 Description | 12 | 6.2 Service Life | 48 |
| 3.2 General Specifications | 13 | 6.3 Inspecting the iNjX | 48 |
| 4 - Features and Controls | 16 | 6.4 Disinfecting Patient Restraints | 49 |
| 4.1 Display Overview | 16 | 6.5 Cleaning Patient Restraints | 49 |
| 4.2 Power Switch | 17 | 6.6 Disinfecting/Cleaning the Pad | 49 |
| 4.3 Light Buttons | 17 | 6.7 Disinfecting the iNjX | 49 |
| 4.4 Display Zones | 18 | 6.8 Cleaning the iNjX | 50 |
| 4.5 iNjX Zone | 18 | 6.9 Pressure-Washing the iNjX | 50 |
| 4.6 Timer Zone | 18 | 6.10 Lubricating the iNjX | 51 |
| 4.7 Status Zone | 19 | 6.11 Adjusting Backrest Control Handle Tension | 52 |
| 4.8 Audible Alarm | 19 | 6.12 Adjusting Tension Of The Actuator Release Handles | 53 |
| 4.9 Battery Zone | 19 | 6.13 Storing the iNjX | 54 |
| 4.10 Battery | 20 | 6.14 Charging the Battery | 54 |
| 4.11 Battery Charger | 21 | 6.15 Storing the Battery | 54 |
| 4.12 Integrated Charging System (ICS®) | 21 | 6.16 Recycling Notice | 55 |
| 4.13 Extend and Retract Buttons | 22 | 6.17 Patient Restraints | 56 |
| 4.14 Sleep Mode | 22 | 7 - Initial Setup | 58 |
| 4.15 Mode-Select Button | 23 | 7.1 Ambulance Information | 58 |
| 4.16 Telescoping Handles | 23 | 7.2 Accessories | 58 |
| 4.17 Position Indicator Lights | 23 | 7.3 Charge and Install the Battery | 58 |
| 4.18 Shock Frame | 24 | 7.4 Set the Loading Height | 59 |
| 4.19 Backrest | 25 | 8 - Technical Data | 60 |
| 4.20 Telescoping Frame | 26 | 8.1 Charger Specifications | 60 |
| 4.21 Safety-Bar Release Levers | 26 | 8.2 iNjX Battery Specifications | 60 |
| 4.22 Sidearms | 27 | 9 - Troubleshooting | 61 |
| 4.23 Locking Pad | 28 | 9.1 Status Indicators | 61 |
| 4.24 Non-Powered Operation (Actuator-Release Handles) | 29 | 10 - Parts and Service | 62 |
| 4.25 Oxygen Cylinder Holder | 30 | 10.1 U.S.A. and Canada | 62 |
| 4.26 Patient Restraint System | 31 | 10.2 Worldwide | 62 |
| 4.27 Accessory Rail | 31 | 10.3 Parts List | 62 |
| 4.28 Wheel Locks | 31 | 11 - Accessories | 63 |
| | | 11.1 Accessories | 63 |
| | | Training Record | 64, 66 |
| | | Maintenance Record | 65, 67 |

1 - SAFETY INFORMATION

1.1 Warning

Warning notices indicate a potentially hazardous situation which, if not avoided, could result in injury or death.

WARNING

Untrained operators can cause injury or be injured. Permit only trained personnel to operate the iNjX.

Helpers can cause injury. Maintain control of the iNjX, operate the controls, and direct all helpers.

Improper use of the iNjX can cause injury. Use the iNjX only for the purpose described in this manual.

Improper operation can cause injury. Operate the iNjX only as described in this manual.

An unattended patient can be injured. Stay with the patient at all times.

An unrestrained patient can be injured. Use properly-installed patient restraints to secure the patient on the iNjX.

Rolling the iNjX above the factory-set maximum transport height can cause it to tip. Only roll the iNjX at or below the factory-set maximum transport height.

Uncontrolled movement can cause injury or damage. Support and control the iNjX at all times.

Sheets or other objects can interfere with, or become entangled in, the height-adjustment locking mechanism. This can cause injury and/or malfunction, including unexpected retracting of the iNjX. Do not tuck sheets or place other objects where they can interfere with, or become entangled in, the locking mechanism.

Rolling the iNjX sideways can cause it to tip. Roll the iNjX only toward the control end or loading end.

Failure to engage the safety hook during loading or unloading can cause injury. Operators must visually ensure each safety bar engages the safety hook and the iNjX is secure inside the ambulance before extending or retracting the legs.

A severe angle can injure the patient and/or operators. Control the iNjX when using a direct power mode.

WARNING

Uncontrolled movement can cause injury or damage. Support the load before using an actuator-release handle.

A severe angle can injure the patient and/or operators. Control the iNjX when operating without power.

Improper maintenance can cause injury. Maintain the iNjX only as described in this manual.

Improper adjustment of the actuator-release handle cables can lead to injury. Adjust the tension of the cables when needed.

The iNjX can rapidly descend and cause injury if the actuator-release handles are activated while you are adjusting the cable tension. Use caution when adjusting cable tension.

Attaching improper items to the iNjX can cause injury. Use only Ferno-approved items on the iNjX.

Charging an improper battery can cause injury and damage. Do not charge non-rechargeable batteries. The Ferno 24/36VDC battery charger is compatible only with the iNjX battery or Ferno POWERPac and ICS systems.

Charge lead-acid batteries only in a well-ventilated area (POWERPac batteries are lead-acid type).

The appliance (battery charger) is not intended for use by people (including children) with reduced physical, sensory or mental capabilities, or lack of experience and knowledge, unless they have been given supervision or instruction concerning use of the appliance by a person responsible for their safety.

Children should be supervised to ensure that they do not play with the appliance (battery charger).

If the supply cord is damaged, it must be replaced by a special cord or assembly available from Ferno or an authorized Ferno distributor or service center.

Modifying the iNjX can cause injury and damage. Use the iNjX only as designed by Ferno.

1.2 Important

Important notices emphasize important operation and/or maintenance information. Failure to follow Important notices could result in product damage or property damage.



1.3 Tip

Tips provide recommendations for easier use of the product.

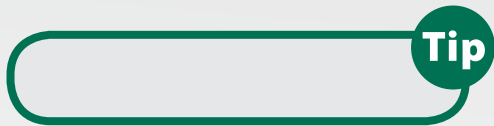

1.4 Bloodborne Disease Notice

To reduce the risk of exposure to blood or other potentially infectious materials when using the iNjX, follow the disinfecting and cleaning instructions in this manual.

























1.5 Fastening System Compatibility

Combining different manufacturers' products such as a Ferno cot with a non-Ferno fastening system can increase the user's risk of injury and damage.

Ferno-Washington, Inc. products are designed for use only with Ferno-manufactured fastening systems. Use of a Ferno product with a non-Ferno fastening system is misuse of the Ferno product. The user assumes responsibility for the outcome of known, intentional misuse.

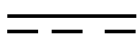
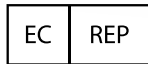
1.6 Symbol Glossary

The symbols defined below are used on the iNjX and/or in this users' manual. Ferno uses symbols recognized by the International Standards Organization (ISO), American National Standards Institute (ANSI) and the emergency medical services industry.

| | | | | | | | |
|---|---|---|--|---|--|---|---|
|  |  |  |  |  |  | | |
| General Warning of Potential Injury | Laser Class 2M Warning: Do Not Stare Into Light | Pinch Point Keep Fingers Clear | Read the Users' Manual | Operation Requires Two Trained Operators | Load Capacity | | |
|  |  |  |  |  |  |  |  |
| OFF | ON | Scene Lights | Emergency Lights | Chair Position | Extend Legs | Retract Legs | Recycling Information (USA) |
|  |  |  |  |  | | | |
| Locked/Unlocked | Product Meets European Union Standards | Lubricate/Do Not Lubricate | Status Indicator: Low or Medium Priority | Status Indicator: High Priority | | | |
|  |  |  |  |  |  | | |
| Manufacturer | DC (Direct Current) electricity | European Community Authorized Representative | WEEE Directive: Dispose of Battery Properly | Do Not Open No User Service In This Area | QR Code (To Access Online Material, Scan with Smartphone or Click this Link in the Electronic Manual) | | |

1.7 Safety and Instruction Labels

Safety and instruction labels place important information from the users' manual on the iNjX. Read and follow label instructions. Replace worn or damaged labels immediately.



Safety Reminders
Location: Control and Loading Ends



Ferno Battery Only
Location: Battery Cradle



Do Not Open
Location: Display Bottom



Safety Reminders
Location: Control and Loading Ends



Sidearm Unlock Labels (2 ea.)
Location: Sidearm



Pinch Point
Location: Actuator Sliding Surface



Laser Emitter Warning (2)
Location: Laser Apertures



Do Not Open/Laser Notice
Location: Controller Housing

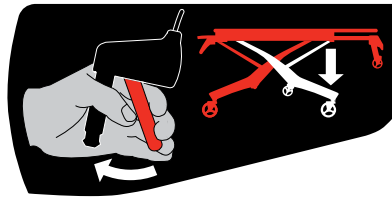

Non-Powered Operation
Location: Actuator-Release Handles (2)

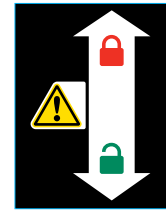

Non-Powered Operation
Handle Lock/Unlock (2)
Location: Handle Mounts

1.8 Compliance: USA Standard SAE J3027

The iNjX® with iNjLINE™ is compatible with the Society of Automotive Engineers SAE J3027 Recommended Practice (2014) when used with additional Ferno equipment (not supplied, available separately).

To comply with the SAE J3027 Recommended Practice (USA), **all three compliant elements must be present:**

1. Ambulance cot
2. Transport restraint system (patient restraints)
3. Fastening system (cot/litter retention system)

FERNO COMPLIANT ELEMENTS

- iNjX® Integrated Patient Transport & Loading System™ for iNjLINE™
- iNjLINE™ Fastening System (Short, Medium, or Long)
- Model 417-3 iNjX® Restraint System

Tip

SAE J3027 Compatibility

To comply with the SAE J3027 Recommended Practice, all three elements are required.

- Compliant ambulance cot
- Compliant restraint system
- Compliant fastening system (cot/litter retention system)

Specifications/Standards Contact Information

For information about AMD standards:

Ambulance Manufacturer's Division
National Truck Equipment Association
37400 Hills Tech Drive
Farmington Hills, MI, 48331-3414
Internet: www.ntea.com

For information about CAAS standards:

CAAS
1926 Waukegan Road, Suite 300
Glenview, IL, 60025-1770
Internet: www.caas.org

**For information about Federal Ambulance Specification
KKK-A-1822 revision F (2007):**

Office of Motor Vehicle Management,
General Services Administration,
2200 Crystal Drive, Suite 1006
Arlington, VA, 22202
Internet: www.gsa.gov/automotive

For information about NFPA® standards:

National Fire Protection Association
1 Batterymarch Park
Quincy, MA, 02169-7471
Internet: www.nfpa.org

For information about SAE standards:

Warrendale, PA, USA - Headquarters
400 Commonwealth Drive
Warrendale, PA 15096
p: +1.724.776.4841
f: +1.724.776.0790
Internet: www.sae.org

For information in Alberta, Canada:

Internet: <http://www.albertahealthservices.ca/>

For information in British Columbia, Canada:

Internet: <http://www.bcehs.ca/>

1.9 Compliance: Worldwide

SPECIFICATIONS AND STANDARDS

The iNjX® for iNjLINE™ meets or exceeds the following global specifications and standards. Be aware: standards and specifications are updated periodically. Current guidelines are available from these organizations.

- **AMD:** Ambulance Manufacturer's Division (AMD) of the National Truck Equipment Association Standard 004 (Oct. 2014), Litter Retention System Static Test.
- **KKK-A-1822 (F):** Federal Ambulance Specification KKK-A-1822 revision F (2007), Change Notice 8 (2015) as applicable.
- **NFPA:** National Fire Protection Association standard NFPA® 1917 (2016 edition).
- **SAE:** Society of Automotive Engineers SAE J3027 Recommended Practice (2014). See below.
- **CAAS:** Commission on Accreditation of Ambulance Services Global Vehicle Standard (GVS) v1.0
- **IP56:** Ingress Protection rating. Tested in compliance with dust and water infiltration standards.
- **IEC 60601-1-2** (electrical and electromagnetic medical equipment standards)
- **IEC 2007/47**
- **MDD:** Ferno products meet the requirements of the European Medical Device Directive 93/42/EEC as established by the European Union.

CANADA

- **CSA: Electronic components meet Canadian Standards Association requirements.**
- **Ontario:** Ontario Land Ambulance Standard, Version 5.0, September 28, 2012; Section 20.1 Main Cot Retention
- **BCAS:** BCAS Ambulance Performance Test Criteria E2 Stretcher Retention
- **Alberta:** Alberta Health and Wellness Ambulance Vehicle Standard Code January 2010; Section 17.5 Cot Retention System Test
- **AMD:** Ambulance Manufacturer's Division (AMD) of the National Truck Equipment Association Standard 004 (August 2007 edition), Litter Retention System Static Test. (Some areas of Canada follow the U.S. AMD specification.)

AUSTRALIA/NEW ZEALAND

AS/NZS 4535:1999. Meets the requirements of the Ambulance Restraint Systems test.

EUROPEAN STANDARDS

- **CE:** Meets European Norms
- **RoHS-2:** Meets the requirements of RoHS-2 (EU Directive 2011/65/EU) on the restriction of the use of certain hazardous substances
- **EN 1789 and EN 1865:** Vehicle, fastening system, and crash-test standards.

2 - OPERATOR FOCUS

2.1 Operator Training

Operators using the iNjX:

- must read and understand this manual.
- must have training on proper use of the iNjX.
- must have training on emergency-medical service and emergency patient-handling procedures.
- must have the physical ability to assist the patient.
- must practice with the iNjX before use with a patient.
- must keep training records. For a sample training record sheet, see "Training Record" on page 64.

Ferno cares about operator and patient safety. For **operator training videos**, visit our iNjX Quick Start training website.

The **Ferno Injury Free** program from Ferno provides training on nutrition, exercise, management of stress and fatigue, ergonomics, and injury prevention, all from an emergency-medical services perspective.

See the Tips at right to scan a QR code with a smartphone or tablet, click a link in an electronic version of this manual, or type the web address into a browser.

2.2 Operator Height and Strength

The iNjX is designed to minimize the need for lifting. Whenever possible, use the powered hydraulic system to:

- extend and retract the legs.
- load the iNjX into and unload it from an ambulance.
- transition between surfaces of varying levels.
- place the iNjX at good height to establish a proper, ergonomic grasping position for the operators.

An excessive load (exceeding the 700 lb/318 kg load capacity) or non-powered operation may require the operators to lift a portion of the load. Use additional help as needed. See "Using Additional Help" on page 10.

WARNING

Untrained operators can cause injury or be injured. Permit only trained personnel to operate the iNjX.

Tip

EMT: Injury Free Training

For training on nutrition, exercise, ergonomics, injury prevention, and more, visit online:

<http://www.fernoems.com/injuryfree>

Or, scan this QR Code with a smartphone:



Tip

iNjX Quick Start Training

To supplement this users' manual, visit the iNjX Quick Start video training support page online:

<http://www.fernoems.com/inx/training>

Or, scan this QR Code with a smartphone:



Important

If the ambulance is parked on an uneven surface, the operators (and any helpers) may need to extend the legs higher than the user-set loading height to allow the iNjX to roll into the ambulance.

Tip

No-Lift Loading/Unloading

Do not lift the iNjX off the ground when using power during the loading or unloading process.

Support and balance the iNjX while rolling it. Use additional help as needed. See "Using Additional Help" on page 10.

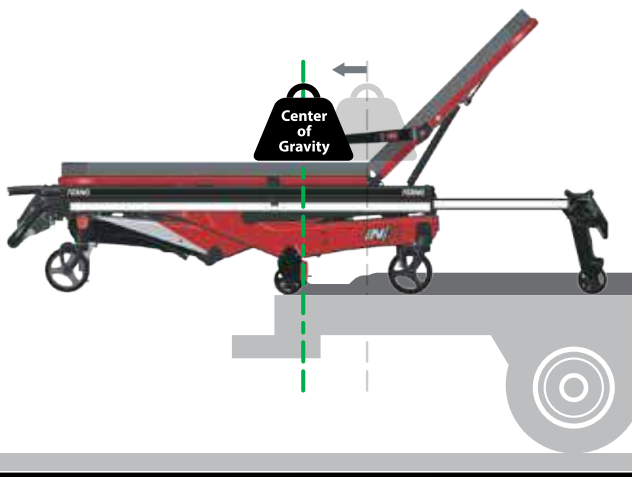
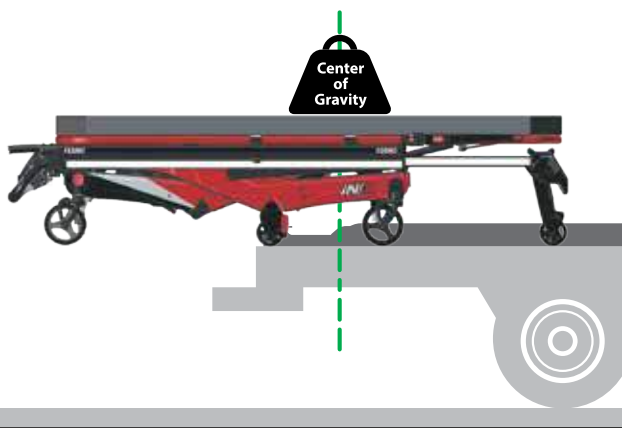

2.3 Daily Operator Duties

It is good practice for operators to check equipment at the start of each work shift. To check the iNjX prior to use, follow the procedures described in this manual:

- Unload the iNjX from the ambulance.
- Retract the iNjX to the floor or ground.
- Extend the iNjX to the recommended rolling height.
- Visually inspect the iNjX for readiness. See "Inspecting the iNjX" on page 48.
- Rotate the iNjX in a circle to verify it rolls easily.
- Load the iNjX into ambulance and secure it in the iNjLINE.
- Verify the iNjX is being charged by the ICS. See "Integrated Charging System (ICS)" on page 21.

2.4 No-Lift Loading/Unloading

The unique design of the iNjLINE fastening system holds the iNjX level with the patient floor as the operators load it into the ambulance (Figure 1), or unload it from the ambulance (Figure 2). During loading and unloading:

- As both operators work together to guide the iNjX into the iNjLINE, the Control-end Operator confirms each iNjX safety bar engages the iNjLINE safety hook.
- **Do not lift the iNjX.** Allow the legs to support the load.
- Verify the legs have clearance before extending or retracting. Look for obstructions such as the ambulance bumper.
- For complete loading and unloading procedures, see "Loading the iNjX" on page 38 and "Unloading the iNjX" on page 40. Use additional help if needed; see "Using Additional Help" on page 10.

2.5 Controlling the Load

When rolling the iNjX, both operators (and any helpers) must keep both hands on the main frame (or guide bar), support and balance the load, and maintain control of the iNjX at all times. Use care on rough or uneven terrain.

Roll the iNjX only at, or below, the maximum transport height. This height is programmed into the iNjX. See "Rolling the iNjX" on page 36. Use additional help if needed; see "Using Additional Help" on page 10.

2.6 Using Additional Help

Operating the iNjX requires a minimum of two trained operators. They may need additional help when working with heavy loads (patient plus equipment). The chart below shows suggested placement for operators and helpers.

When using additional help:

- Operators stand at the loading and control ends of the iNjX, maintain control of the iNjX, operate the controls, and direct all helpers.
- Side helpers may need to walk sideways under some circumstances. Follow local protocols.
- Ferno recommends that helpers work in pairs to help maintain iNjX balance.
- For heavy loads (patient weight exceeding 95th percentile male and heavier), Ferno recommends a minimum of two trained operators and two helpers.

Use special techniques to raise, lower, load, or unload the iNjX without power. See the following sections:

- "Non-Powered Operation: Extending and Retracting" on page 44
- "Non-Powered Operation: Loading" on page 46
- "Non-Powered Operation: Unloading" on page 47

⚠ WARNING

Helpers can cause injury. Maintain control of the iNjX, operate the controls, and direct all helpers.



**700 lb
318 kg**

Load Capacity*

* Operators (and helpers) must provide lift assistance when the load exceeds the load capacity. Inspect the iNjX if the load capacity has been exceeded (see "Inspecting the iNjX" on page 48).

Tip

Directing Helpers



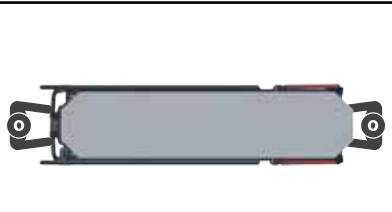
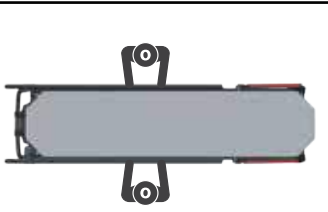
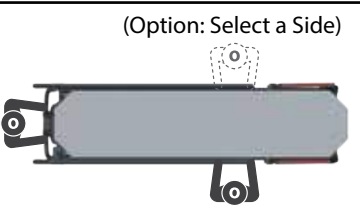

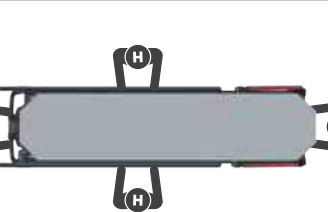
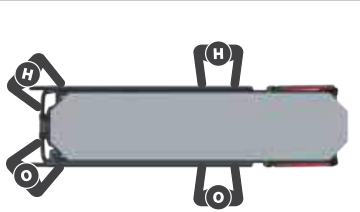
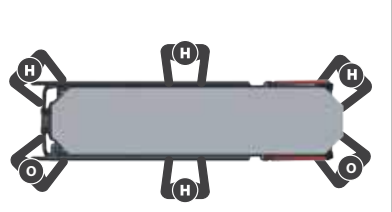
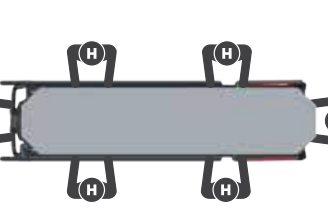
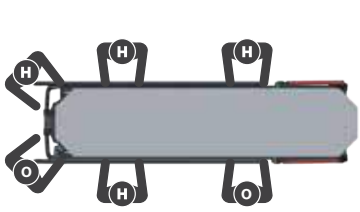
Trained operators position themselves at the loading and control ends of the iNjX and operate the controls. Show helpers where to stand and how to grasp the iNjX.

| | Raising and Lowering | Rolling | Loading and Unloading <small>(Option: Select a Side)</small> |
|---------------|---|--|---|
| Two Operators |  |  |  |

| For Heavy Patients (95th Percentile Male and Heavier), Ferno Recommends: | | | |
|--|---|--|---|
| | Raising and Lowering | Rolling | Loading and Unloading |
| Two Operators, Two Helpers |  |  |  |
| Two Operators, Four Helpers |  |  |  |

Key: O = Operator H = Helper

2.7 Terms

- **ACTUATOR:** The actuator is a hydraulic system that extends and retracts the iNjX legs. One actuator is attached to each set of legs.
- **AUTO-EQUALIZE:** During normal operation, if the legs are not equally extended, pressing  or  will extend or retract one set of legs until both sets of legs are equally extended. Then, both sets of legs extend or retract simultaneously.
- **AUTOMATIC STOPS:** The iNjX stops automatically at the maximum safe transport height (factory-set) and at the loading height (user-set). To continue extending or retracting, press  or  again.
- **CONTROL END:** The control end of the iNjX is where the display, telescoping handles and shock frame are located. This area is also known as the foot end.
- **DISPLAY:** The display provides operators with the status of many iNjX systems, including the legs, patient surface, battery charge, and alternate operating modes. See "Display Zones" on page 18.
- **DRIVE LIGHTS:** Drive lights are white lights on the actuators that illuminate the ground around the wheels and increase iNjX visibility in low light. See "Light Buttons" on page 17.
- **EXTENDING (LEGS):** In this manual, the term "extending" is used to describe raising the patient surface away from the transport wheels. Extend the legs to increase the height of the patient surface, or when unloading the iNjX from the ambulance.
- **GUIDE BAR:** The curved guide bar is used by the control-end operator to guide and maintain control of the iNjX. The display is affixed between the guide bar and the patient surface. A set of  buttons is attached to the right-hand side.
- **iNjLINE:** The iNjLINE fastening system is a Ferno device designed to secure the iNjX in a ground-based ambulance.
- **INTEGRATED CHARGING SYSTEM (ICS®):** The ICS allows the iNjX to be charged each time it is secured in the iNjLINE. (Power to the ICS from the ambulance inverter or shore power must be ON). The ICS helps keep the iNjX battery fully charged.
- **INTERACTIVE CONTENT:** For training videos and proper use of the iNjX, scan a QR code in this manual, click a link in an electronic version of this manual or visit our website at <http://www.fernoems.com/inx/training>.
- **LIFT-ASSIST:** Under extreme weight conditions (loads), the operators may need to provide lift-assistance. Use additional help if needed. See "Using Additional Help" on page 10.
- **LOAD:** The load is the overall weight of the patient plus equipment placed on (or attached to) the iNjX.
- **LOADING END:** The loading end of the iNjX is where the backrest, telescoping frame and one of two safety bars are located. This area is also known as the head end.
- **LOADING HEIGHT:** Users can set the iNjX to stop at the proper normal loading height for an ambulance. See "Set the Loading Height" on page 59. Extend the iNjX to the loading height only to load it into an ambulance or unload it from an ambulance.
- **OPERATORS:** The trained operators are referred to as the Control-end Operator and Loading-end Operator in this manual. The trained operators maintain control of the iNjX, operate the controls, and direct helpers.
- **RETRACTING (LEGS):** In this manual, the term "retracting" is used to describe lowering the patient surface toward the transport wheels. Retract the legs to reduce the height of the patient surface, or when loading the iNjX into an ambulance.
- **SURROUND LIGHTS:** Surround lights are red and white lights on each side of the iNjX that provide steady light to illuminate the iNjX, or flash in an attention-grabbing alert pattern to increase safety. See "Light Buttons" on page 17.
- **TELESCOPING HANDLES:** Telescoping handles extend or retract to provide the control-end operator with additional ergonomic positions to grasp and guide the iNjX. A set of  buttons is attached to the right-hand telescoping handle. See "Telescoping Handles" on page 23.
- **TRANSPORT HEIGHT:** An alarm beeps when the patient surface is higher than the recommended maximum transport height. Keep the iNjX at or below this height when rolling it.
- **SHEETS:** Sheets or other articles that are placed, or find their way, beneath the patient surface can become caught in the power system. Do not tuck sheets or place other objects where they can interfere with, or become entangled in, the locking mechanism.

3 - iNjX OVERVIEW

3.1 Description

The Ferno® iNjX® Integrated Patient Transport & Loading System™ for iNjLINE™ is an emergency patient-handling device designed to transport a patient over various terrain, to be loaded into and unloaded from an ambulance, and for transport inside a ground-based ambulance.

In this manual, the term "iNjX" is used to represent the iNjX® Integrated Patient Transport & Loading System™ for iNjLINE™.

The iNjX is for professional use by a minimum of two trained operators. The iNjX is designed to help reduce the risk of back injury to medical service personnel by eliminating or minimizing the amount of lifting required to extend or retract the legs.

During powered operation, the iNjX does not require lifting when loading into an ambulance or unloading from an ambulance.

The iNjX is for use with Ferno® iNjLINE™ series fastening systems (not included).

The iNjX may be operated manually when desired.

COMPATIBLE FASTENING SYSTEMS

- Ferno® iNjLINE™ series fastening system



INCLUDED

- Ferno® battery charger and adapter cable
- iNjX battery
- Locking pad constructed of 2-way stretch polyurethane cover; sealed; cover treated with antimicrobial additive
- Set of patient restraints
- Users' manual and training DVD
- ICS® charging contacts standard

WARNING

Improper use of the iNjX can cause injury. Use the iNjX only for the purpose described in this manual.

FEATURES

- 700 lb/318 kg lifting capacity (load capacity)
- Independent-leg, powered transport loading system
- Legs auto-equalize before extending or retracting
- Safety Lighting System
- Variable height adjustment allows level loading into an ambulance with a floor of up to 35" (889 mm)
- User-set loading height (maximum 35"/892 mm)
- Meets IP 56 (Ingress Protection rating) dust, water
- 36-Volt DC power system with dual actuators
- Multifunction display
- Position-indicator lights
- Simple   operation
- Multi-position sidearms
- Telescoping handles (control end)
- Coated handling surfaces keep hands/clothes clean
- Four 6-inch, tri-spoke swivel transport wheels
- 2 Wheel locks
- Pneumatic backrest
- Three-position telescoping loading-end frame
- Two-position shock frame
- Direct power and non-powered backup systems

3.2 General Specifications



| Dimensions | Imperial | Metric |
|--|-------------|----------------|
| A) Wheels | 6" x 1.7" | 152 mm x 43 mm |
| B) Length (Adjustable) | 63" – 81" | 1594-2045 mm |
| C) Width (Overall) | 24" | 597 mm |
| D) Width (Patient Surface) | 16" | 406 mm |
| E) Height ¹ (Adjustable) | 14" – 49" | 356-1245 mm |
| F) Maximum Transport height (Factory-Preset, measurement is to patient surface) | 34" | 864 mm |
| G) Loading Height ² (Adjustable, measurement is to bottom of loading wheel) | 35" Maximum | 889 mm Maximum |
| H) Backrest Adjustment | 0°-76° | |
| I) Shock Frame Adjustment | 0°-16° | |

Weight

Equipped for Ferno®
iNjLINE™ Series Fastening System³ 207 lbs/94 kg

Power System

| | |
|--|--|
| Operating Temp. | -40°F to 131°F (-40°C to 55°C) |
| Battery Output | 36 Volts DC |
| Charging Time (1 transport, charge maintained by ICS®) | As little as 15 minutes ⁴ |
| Charging Time (depleted) | Up to 1 hour, 45 minutes |
| Charger Input | 100 – 240 Volts AC |
| Charger Output | Up to 39.6 Volts DC, 2 Amps (for iNjX LiFePO4 battery) |

Soft Goods

Locking Pad 72.5"x16.5"x3"/1842x419x73 mm

Load Capacity

Imperial/Metric 700 lbs/318 kg
Stone (UK) 50 st

iNjX Construction

| | |
|---------------------------|---|
| Frame | Aluminum |
| Legs | Carbon-Fiber Composite |
| Bed Surface | Aluminum |
| Wheels | Stainless steel, sealed bearings; Nonconductive wheels |
| Position Indicator Lights | Class 2M Laser |

General specifications are rounded. Metric conversions are calculated before rounding. Ferno reserves the right to change specifications without notice.

¹Height: Distance from the ground to the patient surface.

²Loading Height: Distance from the ground to the bottom of the loading wheels.

³Weight includes battery weight but is without pad, patient restraints and optional features.

⁴Integrated Charging System Maintains the battery charge when the iNjX is secured in the iNjLINE. See "Integrated Charging System (ICS)" on page 21.

Note: The locking patient pad is sealed.

Control-End View

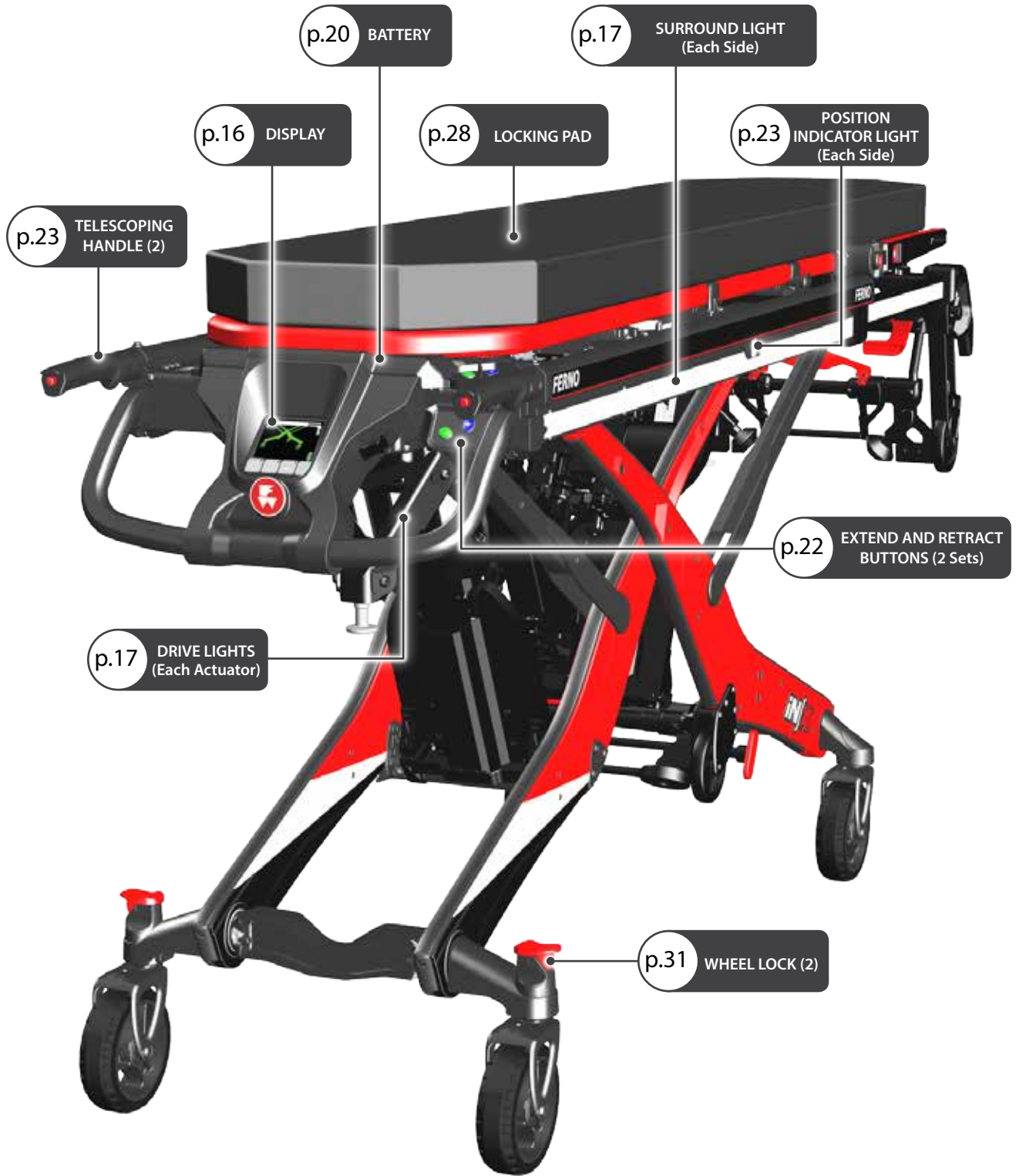

Loading-End View

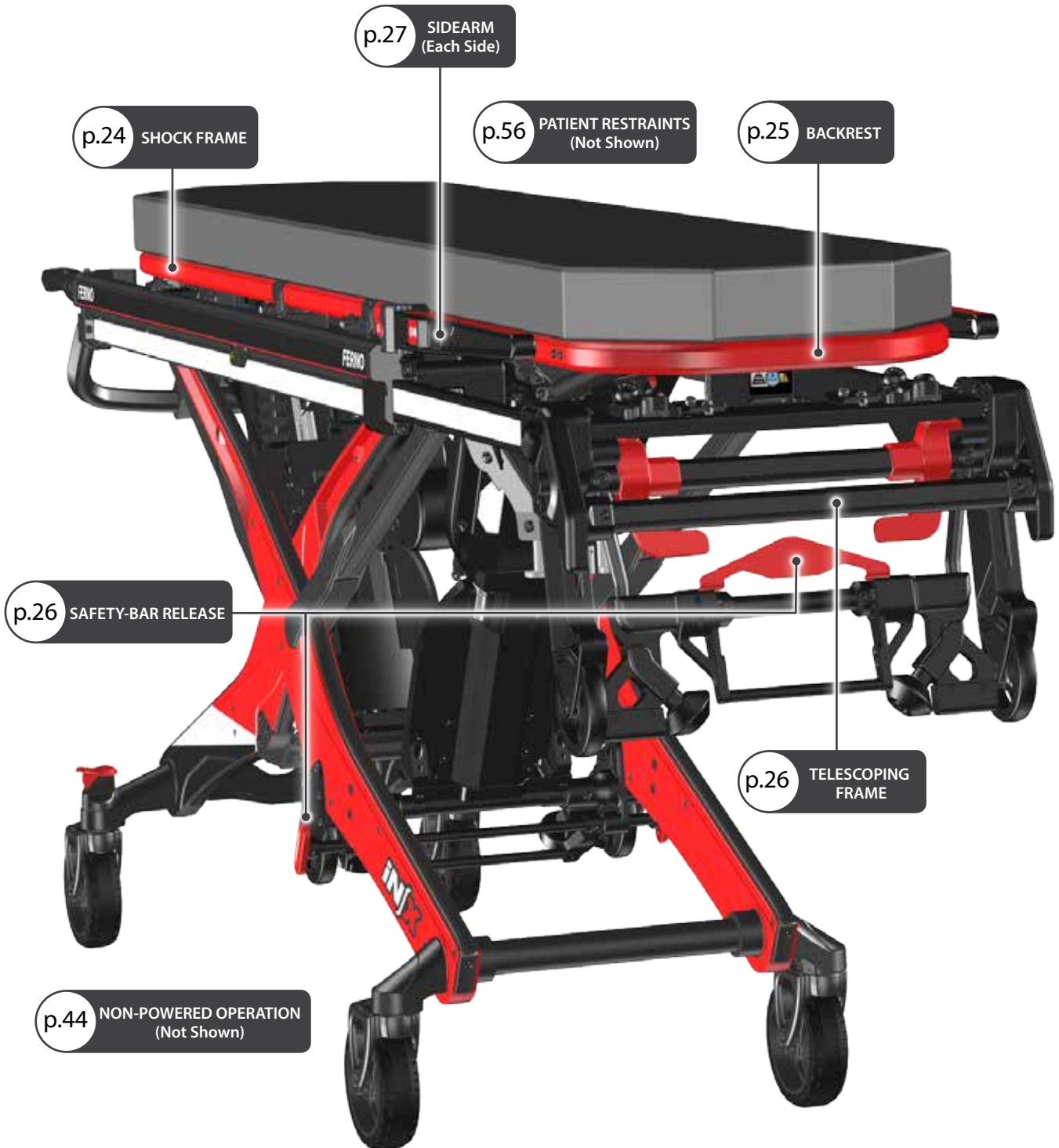

4 - FEATURES AND CONTROLS

4.1 Display Overview



Tip

Display UV Protection

The display screen inner surface is coated with a layer to protect it against ultraviolet (UV) light and pressure damage. This clear surface is normally invisible but may sometimes be seen as lines of clear "dots" when viewed at an angle. This is normal.

Important

Turn the power OFF when the iNjX will not be in use. For extended storage, see "Storing the iNjX" on page 54.

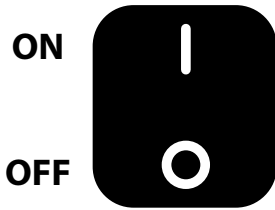

3

Tip

Using Lights

- Drive Lights illuminate the ground around the iNjX to assist the operators.
- Surround Lights increase the visibility of the iNjX and the area around it.



4

4.2 Power Switch

The power switch (Figure 3) is located on the right side of the display. Keep the switch in the ON (I) position for all iNjX operations.

If the iNjX will not be used for more than 30 minutes, turn the power switch OFF (O) to conserve battery power.

After 10 minutes of non-use, the iNjX will enter Sleep Mode to conserve power. See "Sleep Mode" on page 22.

The iNjLINE features a built-in Ferno® ICS® Integrated Charging System. With ICS, the iNjX power switch can be left ON. The ICS disables the iNjX powered mode and charges the battery. See "Integrated Charging System (ICS)" on page 21.

4.3 Light Buttons

The iNjX safety lighting system (Figure 4) provides light for the terrain around the iNjX and increases operator and patient safety by increasing visibility of the iNjX.

- **Surround Lights** are white and red lights that span the length of each side of the iNjX to increase visibility of the iNjX. These lights can flash or provide steady light.
- **Drive Lights** are affixed to each actuator and provide steady light to illuminate the terrain around the iNjX.

Note: Surround Lights and Drive Lights are ON or OFF at the same time. Lights also turn OFF when the iNjX enters Sleep Mode. See "Sleep Mode" on page 22.

The iNjX safety lighting system is controlled by two buttons. An LED in the upper-right corner of the button indicates the active lights.

SCENE LIGHTS



Press ON. The Drive Lights and Surround Lights illuminate with steady white light.

Press OFF: All lights OFF.

EMERGENCY LIGHTS



Press ON. The Drive Lights illuminate with steady white light. The Surround Lights illuminate and flash in a sequence of red-red-white.

Press OFF: All lights OFF.

4.4 Display Zones

The display is ON when the power switch is ON, and OFF when the power switch is OFF or when the iNjX enters Sleep Mode.

To turn the display ON, use the power switch (see "Power Switch" on page 17). To awaken from Sleep Mode, press . See "Sleep Mode" on page 22.

The display is divided into four zones (Figure 5):

- **iNjX ZONE:** This zone displays the iNjX with areas color-coded to indicate the current status of each area.
- **TIMER ZONE:** This zone is illuminated when the iNjX is in an alternate operating mode. It displays a countdown timer. See "Direct Power Modes" on page 42.
- **STATUS ZONE:** This zone illuminates with indicators to provide function and safety information. Based on the condition, a warning triangle, other symbol, and/or alphanumeric code may be displayed. See "Status Zone" on page 19 and "Status Indicators" on page 61.
- **BATTERY ZONE:** This zone indicates the charge of the battery. See "Battery Zone" on page 19.

Note: For alternate-mode screens, see "Direct Power Modes" on page 42 and "Set the Loading Height" on page 59.

Tip

Press Green to Go

To activate the iNjX after turning the power switch ON, or to wake the iNjX from Sleep Mode, press . Note: Only the button will activate/wake up the iNjX.

4.5 iNjX Zone

The main display area shows the iNjX (Figure 5). The color of the legs and patient surface indicates the current status of these areas. Refer to the iNjX Zone Indicators table at right.

The iNjX zone is illuminated whenever the power is ON.

4.6 Timer Zone

A countdown timer is visible in the lower-left corner of the display only when an alternate operating mode is selected (Figure 6). Use the mode-select button to select an alternate operating mode. See "Mode-Select Button" on page 23 and "Direct Power Modes" on page 42.

If the countdown timer is allowed to expire, the iNjX returns to its default operational mode and normal display screen.

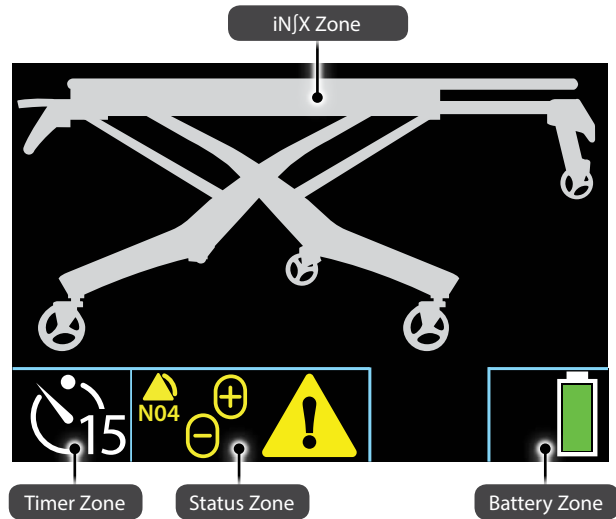

5

| iNjX Zone Indicators | |
|----------------------|--|
| LEG | |
| Green | The legs may be extended and/or retracted. |
| White | The legs will not extend or retract. |
| Blue | The iNjX is in a direct power mode. The blue legs will move when a button is pressed. |
| PATIENT SURFACE | |
| White | The iNjX is at a safe transport height. |
| Yellow/Red | The iNjX is above the maximum recommended transport height. Lower the iNjX before rolling. |
| WHEELS | |
| Green/White | The iNjX may be rolled, if the patient surface is at a suitable transport height. |
| Red | Do not roll the iNjX. |

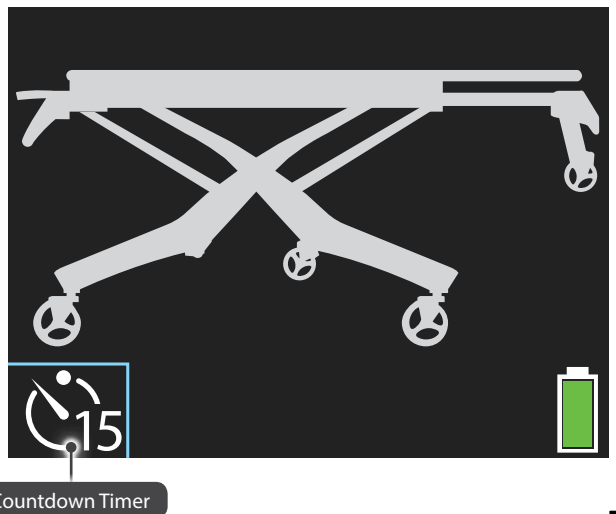

6

Important

The iNjX beeps when a status indicator is displayed. The severity of the status determines the number of beeps.

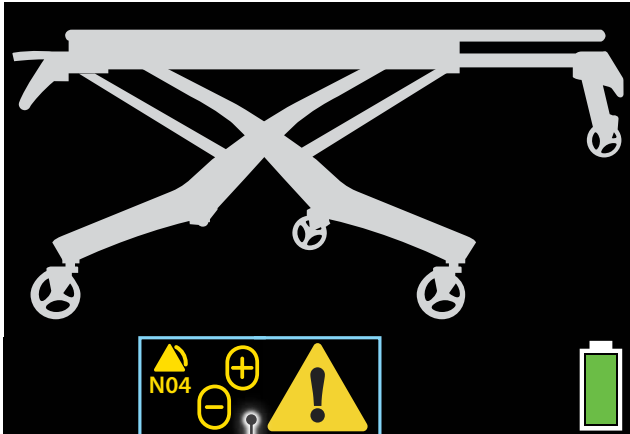

4.7 Status Zone

The status zone alerts the user to important or unsafe conditions, or faults. A warning triangle indicates safety notices. The warning triangle is yellow for medium-level notices, and red for high-priority notices (Figure 7).

The status zone is illuminated only when a status indicator is being displayed. See "Status Indicators" on page 61 for a chart of status indicators.

4.8 Audible Alarm

The iNjX will sound a series of beeps when a status indicator is displayed. The number of beeps is dependent on the severity of the situation. The alarm continues to sound until the status returns to normal.

- **High-priority:** 2+3 beeps, pause, repeat
- **Medium-priority:** 2 beeps/15 seconds
- **Low-priority:** 1 beep/minute

4.9 Battery Zone

The battery zone indicates the charge remaining in the battery. The color of the indicator shows the approximate charge (Figure 8).

Yellow with Lightning Bolt: Connected to ICS, charging

Green with Lightning Bolt: Connected to ICS, full charge

Green: Full charge

Yellow: Moderate charge

Red: Low charge (one-third of the indicator is steady red)

Flashing (final warning): The battery is depleted. The indicator flashes between an empty battery outline and a filled red battery. Swap for a charged battery as soon as possible, or connect to the ICS.

See "Attaching the Battery" on page 20 or "Integrated Charging System (ICS)" on page 21.

The battery zone is illuminated whenever the power is ON or the iNjX is connected to the powered ICS in the iNjLINE.

7

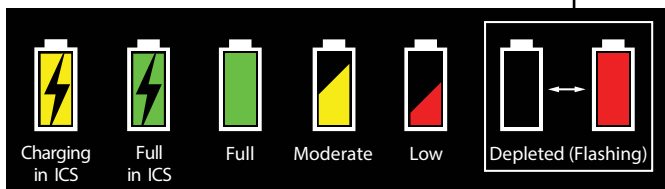

8

4.10 Battery

The iNjX is powered by a rechargeable, 36 Volt DC lithium iron phosphate battery (LiFePO₄). The battery is installed under the patient surface, behind the display (Figure 9).

BATTERY OVERVIEW

- Charge the battery only with the Ferno-provided charger or by securing the iNjX to the ICS integrated into the iNjLINE. See "Battery Charger" on page 21 and "Integrated Charging System (ICS)" on page 21.
- The battery has no "battery memory." You do not need to fully discharge before recharging.
- Patient weight and extreme temperatures affect the amount of use available from each battery charge.
- Minimum charging time is 15 minutes, after one transport and maintaining the charge using the ICS.
- Maximum charging time is 1 hour, 45 minutes using the battery charger (not with ICS) with a depleted battery.
- Actual charging time varies based on frequency of recharge, depth of discharge, and battery age. If a battery becomes deeply discharged, extend the charging time.

REMOVING THE BATTERY

1. Turn the power switch OFF.
2. Raise the shock frame.
3. Place your thumbs under the front corners of the battery cover and lift to remove.
4. Grasp the battery-cable plug and disconnect the cable from the battery port (Figure 10). Do not pull on the cable to disconnect the plug.
5. Use the battery carry handle to lift the battery up and away from the cradle.

ATTACHING THE BATTERY

1. Verify the power switch is OFF.
2. Raise the shock frame.
3. Place your thumbs under the front corners of the battery cover and lift to remove.
4. Angle and slide the battery into the cradle. Press down to lock the battery in place in the cradle.
5. Connect the battery cable plug to the battery port.
6. Insert the front tabs of the battery cover into the slots and then press down the area near the display to snap the cover into place.
7. Lower the shock frame.

Tip

Battery Recycling

In the U.S.A. and Canada, contact Call2Recycle toll-free for a nearby location to responsibly dispose of a Ferno rechargeable battery. See "Recycling Notice" on page 55.

Or, contact the government of your state, territory or country for recycling information. See "Recycling Notice" on page 55.

Tip

Battery Tips

You do not need to fully discharge the battery before recharging. Place the battery on the charger at any time to maintain a full charge.

Turn the iNjX power OFF if it will not be used for more than 30 minutes.

If the iNjX or battery will be placed in storage, charge the battery first. Store only a fully-charged battery. See "Storing the Battery" on page 54.



9

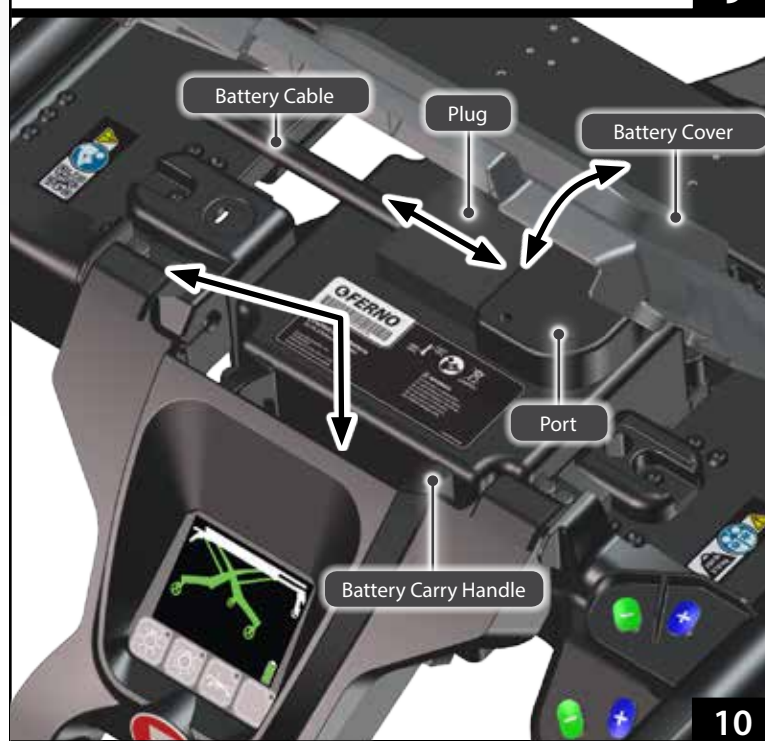

10

Important

Connecting a charger directly to the iNjX can damage cables when the iNjX is unloaded. Cables can also create a trip hazard.

To charge the iNjX inside an ambulance, use only the Ferno® ICS® built into the iNjLINE.



4.11 Battery Charger

Use only the provided Ferno battery charger (Figure 11) to charge Ferno batteries, and charge only Ferno batteries with the charger. A battery-adapter cable (supplied) connects the battery charger to an iNjX battery. The charger has two indicator lights (red and green). See the chart below.

- **Charger Compatibility:**
 - 110 Volts AC, 50/60 Hz (U.S.A., Canada, Japan)
 - 230 Volts AC, 50/60 Hz (Europe and other areas)
- **Charger Input:** AC ~100-240V, 50~60 Hz, 92W

There are two ways to charge the battery: Secure the iNjX in an iNjLINE fastening system, or remove the battery from the iNjX and connect the battery directly to a Ferno battery charger.

See "Charging the Battery" on page 54.

Charger Indicator Lights: When Used with iNjX Battery

| | |
|--|--|
| Red light (3x slow flash) | Initial power on. Battery disconnected/not detected. |
| No lights (connected to power) | Standby/Ready |
| Red light (solid) | Charging |
| Green light (slow flash) | Charging (deeply discharged) |
| Green light (solid) | Charging complete |
| Alternating Red/Green (slow flash) | Battery fault |
| Green light (fast flash) | Charger fault (over voltage) |
| Red light (3x slow flash)/ Green light (1x flash) | Short circuit protection activated. Once short is no longer present, normal operation resumes. |

Fast flash: the light flashes 10 times per second.

Slow flash: the light flashes once per second.

Tip

Deeply-Discharged Battery

If the battery is deeply discharged, the ICS may not be able to charge the battery. Connect the battery directly to a charger separate from the ambulance and ICS.

4.12 Integrated Charging System (ICS®)

The Ferno® Integrated Charging System (ICS®), disables powered operation when the iNjX is locked in the iNjLINE (Figure 12) and the ICS is connected and powered. The ambulance ignition, inverter, and/or outlet switch may need to be turned ON to supply electrical power to the ICS.

11



12

4.13 Extend and Retract Buttons

Two sets of Extend and Retract buttons are affixed to the control end of the iNjX, where they are accessible to the operator's right hand. One set is affixed to the telescoping handle, while the other set is affixed to the guide bar (Figure 13). The function of each set of buttons is identical.

AUTO-EQUALIZING FEATURE

When a button is pressed, one set of legs extends or retracts until both sets of legs are equally extended. Continue pressing the button to extend or retract the iNjX.

+ **EXTEND:** If the legs are not equally extended, the more-retracted set of legs extends to equalize the legs. Then, both sets of legs extend together.

- **RETRACT:** If the legs are not equally extended, the more-extended set of legs retracts to equalize the legs. Then, both sets of legs retract together.

STOPS

In addition to stopping at the maximum and minimum heights, the iNjX stops automatically when it reaches the factory-set maximum recommended transport height and the user-set loading height.

When the iNjX stops at the transport or loading height, press **+** or **-** again to continue extending or retracting the legs.

Note: *The iNjX stops at the user-set loading height only when extending. To set the loading height, see "Set the Loading Height" on page 59.*

LOADING AND UNLOADING

If the iNjX is being supported by the ambulance floor, pressing **+** or **-** will extend or retract only one set of legs at a time. See "Loading the iNjX" on page 38 and "Unloading the iNjX" on page 40.

4.14 Sleep Mode

Sleep Mode conserves battery power. If the iNjX is not in use for more than 10 minutes (no buttons pressed), the system enters Sleep Mode. In Sleep Mode, the display and all lights are OFF.

Press the **-** button to activate the iNjX. When the display is active, press **+** or **-** to extend or retract the legs.

Tip

Automatic Stops

The iNjX automatically stops at:

- the factory-set maximum transport height
- the user-set loading height

To continue, re-press **+** or **-**.



13

Tip

Press Green to Go

To activate the iNjX after turning the power switch ON, or to wake the iNjX from Sleep Mode, press **-**. Note: Only the **-** button will activate/wake up the iNjX.



4.15 Mode-Select Button

The mode-select button is located on the left side of the display (Figure 14) and allows the user to cycle between three direct power modes and the set-loading height feature. Direct power modes are rarely used. See "Direct Power Modes" on page 42.

Each button press cycles to the next mode, with matching images on the display. The button-press sequence is:

- Direct power both legs
- Direct power loading-end legs only
- Direct power control-end legs only
- Loading-height set mode. See "Set the Loading Height" on page 59.
- Standard operating mode

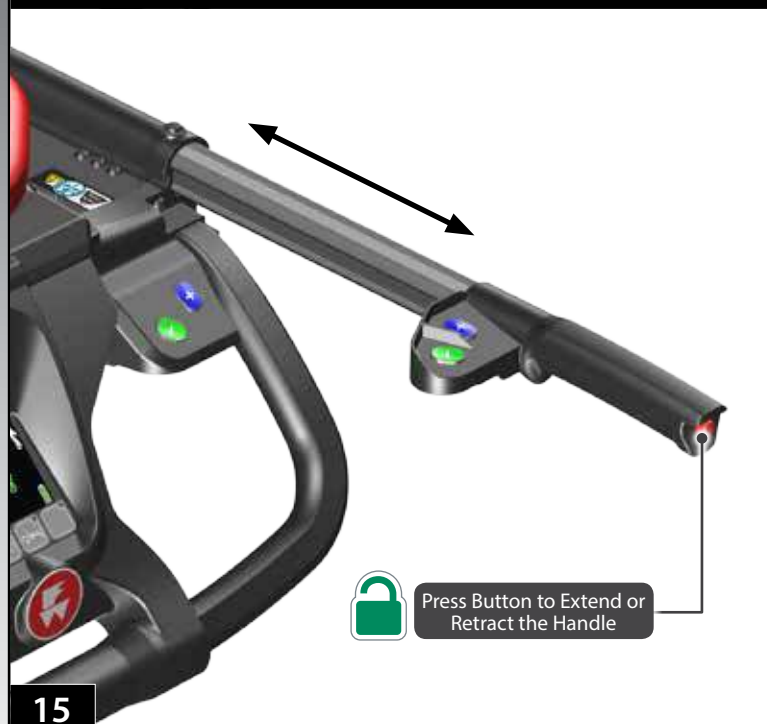

4.16 Telescoping Handles

The telescoping handles lock in two positions: fully retracted and extended (about 9 in/225 mm). Use the telescoping handles only when they are in a locked position.

To change the handle position:

1. Press the red button on the end of the handle (Figure 15), then push or pull the handle to the desired position.
2. Release the button. Push or pull the handle to verify it has locked.

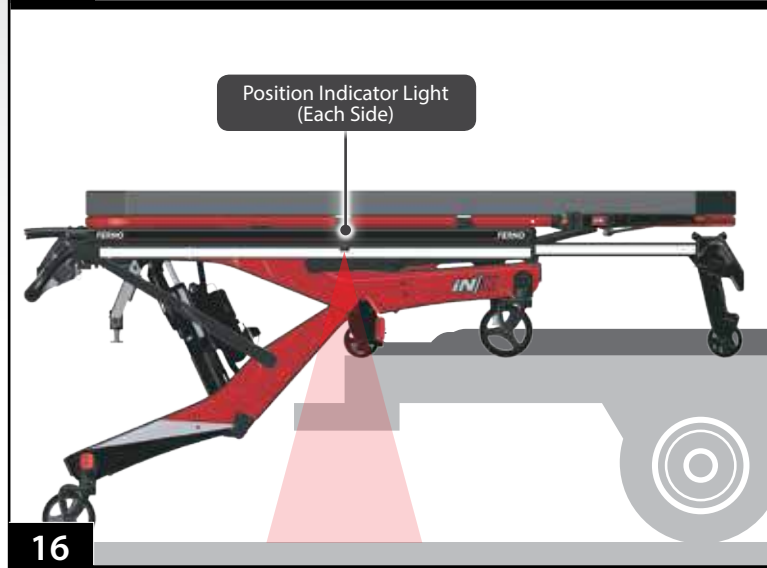

4.17 Position Indicator Lights

The position indicator lights (Figure 16) project a red line on the ambulance floor as a visual aid for the operators. The lights have no effect on iN|X operation.

The position indicator lights are activated during the loading and unloading processes to help the operators visually locate the proper position to stop rolling the iN|X and extend or retract the control-end legs.

The red line shows the approximate position of the intermediate loading wheels. If the line is visible on the ambulance floor, then the intermediate loading wheels and the majority of the load (the weight on the iN|X) are also inside the ambulance.

4.18 Shock Frame

The shock position elevates the patient's feet approximately 16° (Figure 17). Follow your local medical protocols when deciding to use the shock frame.

Use an underhand grip (palms up) to support the shock frame when raising or lowering it. For proper, ergonomically-correct operation, always work from the control end of the iNjX.

RAISING THE SHOCK FRAME

1. Unfasten or loosen the leg restraint.
2. Lift the shock frame with both hands until it locks in the raised position. The support bars engage automatically.
3. Fasten and adjust the leg restraint.

LOWERING THE SHOCK FRAME

1. Unfasten or loosen the leg restraint.
2. Support the weight of the shock frame with both hands and lift slightly.
3. Using both thumbs, press the shock frame control levers (Figure 18) to disengage the support bars, then lower the shock frame.
4. Fasten and adjust the leg restraint.

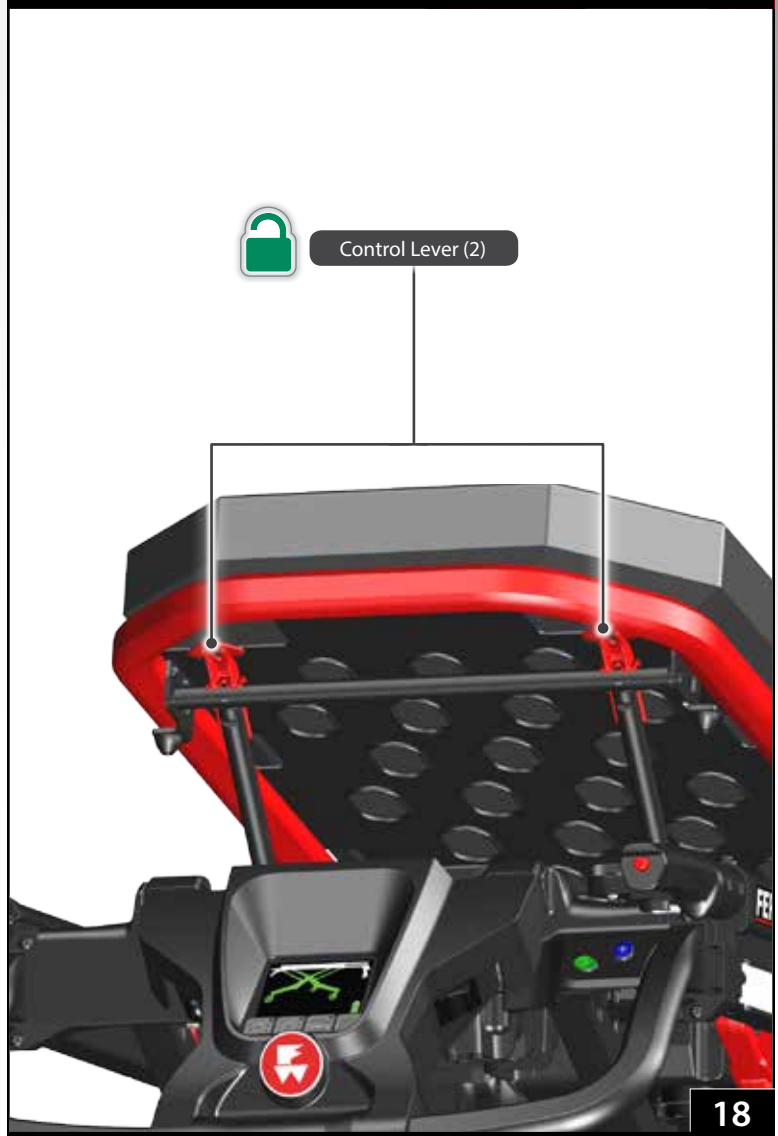

Important

Do not lift the iNjX by the backrest. Lift only by grasping the main frame.



4.19 Backrest

The backrest adjusts between 0° and 76° to elevate the patient's torso for patient comfort or medical necessity (Figure 19).

The gas spring is under pressure to ease raising and lowering. With a heavy patient, support the patient's weight before adjusting the backrest. With a light patient, control the upward movement of the backrest so it does not move too quickly.

USING THE BACKREST

1. Loosen or unbuckle the pelvis and/or chest straps if needed. See "Patient Restraints" on page 56.
2. Adjust the sidearms. See "Sidearms" on page 27.
3. Support the weight of the backrest and patient before using the control handle.
4. Squeeze either red control handle toward the backrest frame to unlock the backrest (Figure 20).
5. Raise or lower the backrest to the desired position, then release the control handle to lock the backrest.
6. Adjust the sidearms as needed for patient comfort.
7. Adjust and fasten the patient restraints.



4.20 Telescoping Frame

Use the telescoping frame (Figure 21) to shorten the iNjX and improve maneuverability in tight spaces (Figure 22). There are two locked positions: extended and retracted. A third, unlocked position fully retracts the frame to shorten the iNjX to its minimum length (when used with a raised backrest).

- Use only a locked position when lifting the iNjX.
- The telescoping frame must be locked in the extended position before loading the iNjX into an ambulance or unloading the iNjX from an ambulance.
- Do not lower the iNjX to its minimum height with the frame in the fully-retracted position.

USING THE TELESCOPING FRAME

1. Loosen or unbuckle the pelvis strap if needed.
2. Raise the backrest.
3. Adjust and fasten the pelvis strap.
4. Squeeze the telescoping frame release handle (Figure 21) toward the lift bar and begin pushing or pulling the frame, then release the handle. Continue pushing or pulling the frame until it locks at the new position.

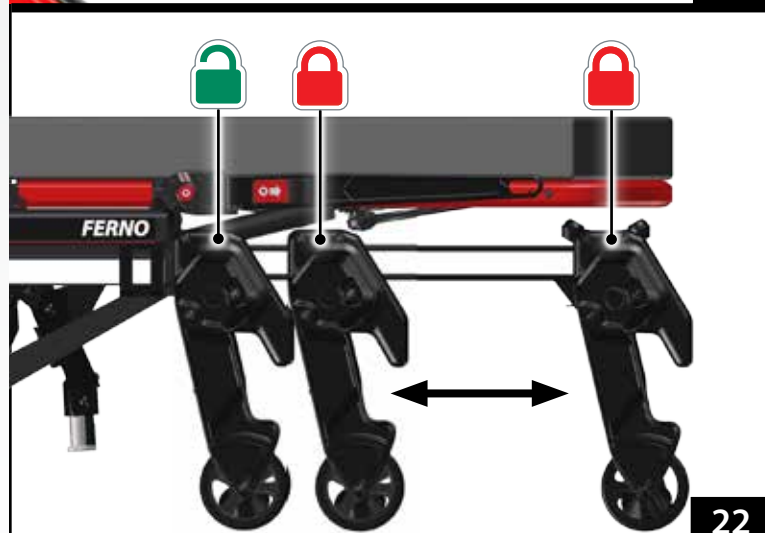
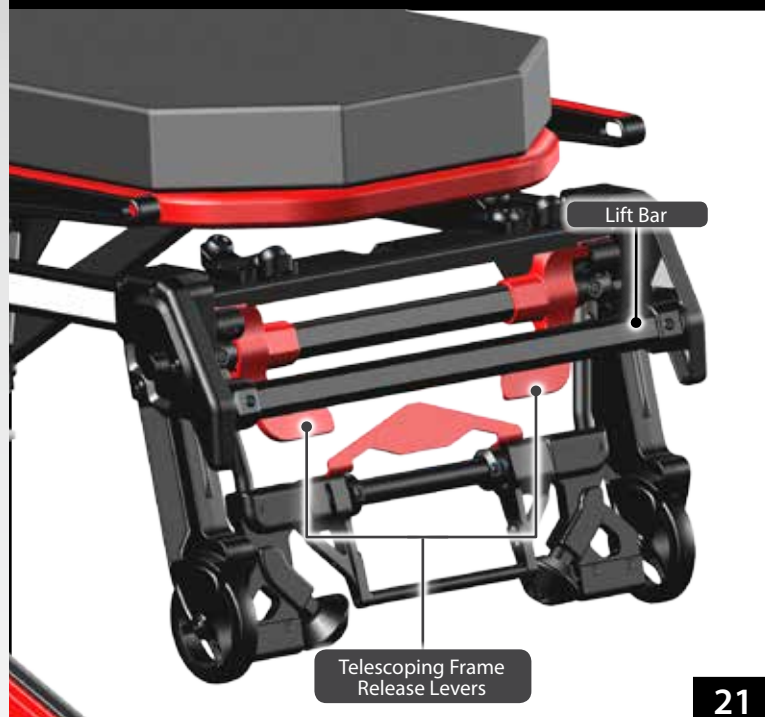

4.21 Safety-Bar Release Levers

Use the safety-bar release levers to disengage each safety bar from the safety hook.

A set of release levers is located on the telescoping frame and on the loading-end legs (Figure 23).

Release each safety bar from the safety hook by turning the bottom of the release lever away from the center of the iNjX. Also see "Loading the iNjX" on page 38 and "Unloading the iNjX" on page 40.

Tip

Using Release Levers

Turn the bottom of the lever away from the center of the iNjX.

When standing at the patient left side, turn the bottom of the lever counter-clockwise.

When standing at the patient right side, turn the bottom of the lever clockwise.



Important

When used in the outward position, sidearms increase the overall width of the iNjX. Use caution when moving through doorways or other narrow areas. Swing the sidearms to the in-line position if needed.

Tip

Sidearm Hole

The small hole in the end of each sidearm allows attachment of handcuffs by law enforcement or other devices (not supplied) to help restrain a combative patient.



24



25

4.22 Sidearms

Sidearms provide patient security and comfort.

Note: Each sidearm adjusts independently.

- **To rotate a sidearm:** Press the red button in the center of the sidearm mount casting (Figure 24) and rotate the sidearm to a new position. Locking positions are at approximately 45° intervals.
- **To swing the sidearms outward:** Slide the lever away from the mount casting to unlock the sidearm and swing it away from the patient surface (Figure 25). This position is useful for a large patient or to position the patient's arm at a convenient angle for starting intravenous (IV) lines.
- **To swing the sidearms inward:** Push the sidearm toward the center of the iNjX to lock the sidearm in the in-line position.
- **To store the sidearm:** Rotate the sidearm toward the loading end of the iNjX, aligned with the backrest.

4.23 Locking Pad

The pad is fitted with eight locking discs to secure it on the patient surface (Figure 26). To attach the pad:

1. Position the pad on the patient surface. Raise the iN|X if desired.
2. Press down the center of the pad to guide the locking discs through the seat panel. Twist the discs 90° to lock them in place (Figure 27).
3. Raise the backrest and shock frame as needed.
4. Guide each locking disc through a hole in the patient surface and twist 90° to lock (Figure 27).

Note: The locking discs can be turned in either direction.

To remove the pad, twist the locking discs 90° and guide them through the patient surface.

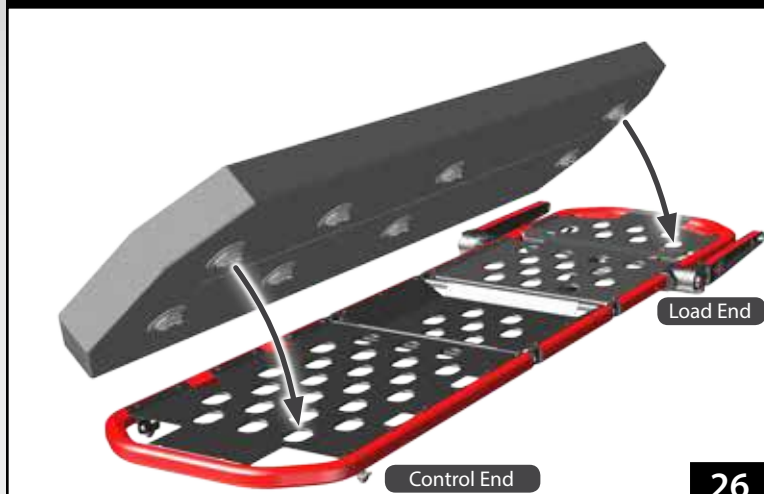

26

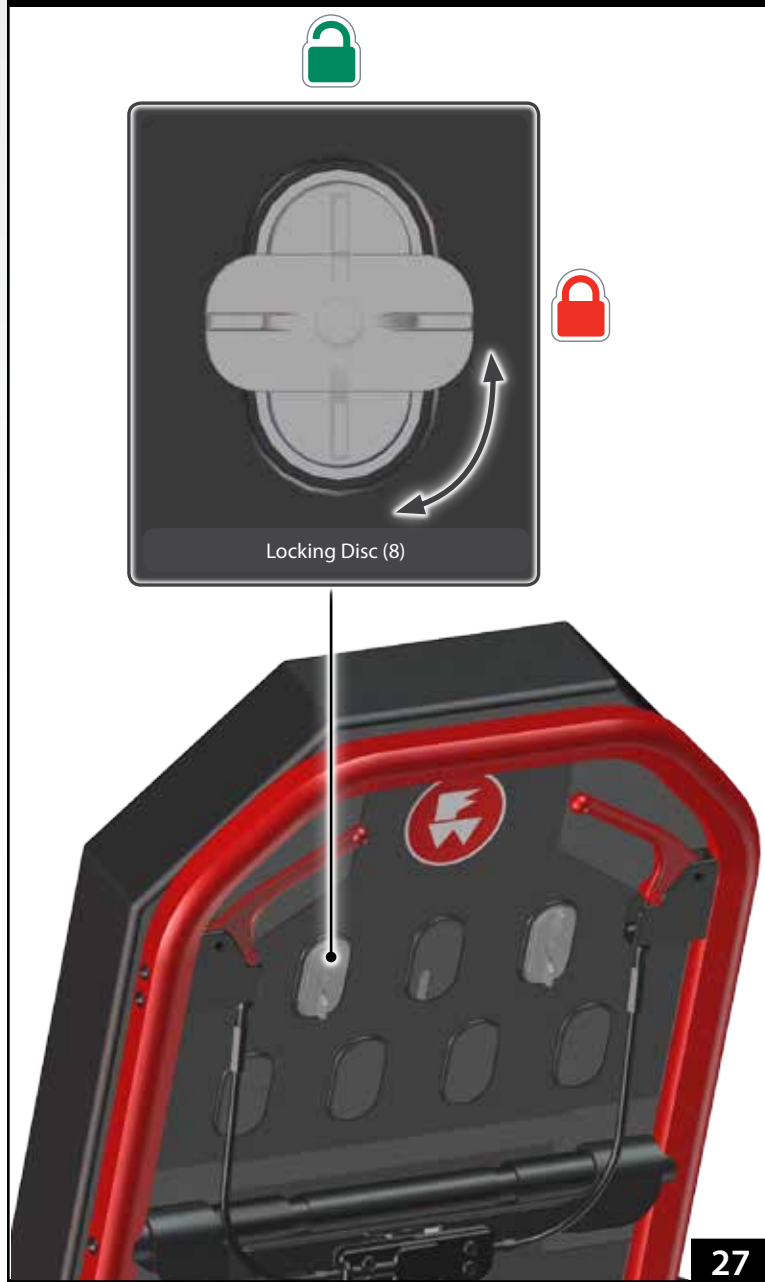

27



4.24 Non-Powered Operation (Actuator-Release Handles)

The actuator-release handles allow non-powered operation. Each handle allows one set of legs to be raised or lowered without power. The handles are located:

- Control-end legs: below the shock frame (Figure 28)
- Loading-end legs: below the backrest frame (Figure 28)

To unlock a handle from the storage mount, pull the handle straight out of the mount. To re-secure, press the handle into the mount until it snaps into the locked position.

For instructions on operating the iNjX using the actuator-release handles, see the following sections:

- "Non-Powered Operation: Raising and Lowering" on page 44
- "Non-Powered Operation: Loading" on page 46
- "Non-Powered Operation: Unloading" on page 47

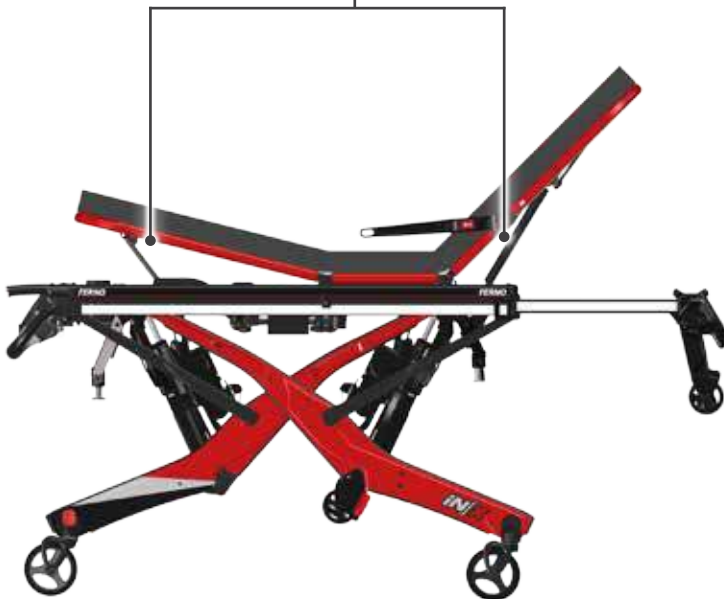

4.25 Oxygen Cylinder Holder

The iNjX features an integrated oxygen-cylinder holder, mounted to the telescoping frame (Figure 29).

The oxygen cylinder holder can carry a D or Jumbo D-sized portable oxygen cylinder, up to a maximum 5.3 inches in diameter by 18.75 inches in length (135 mm diameter x 476 mm length). Spiracle Technology's "DD-Lite" oxygen cylinder is also compatible with this oxygen cylinder holder.

To secure a cylinder on the holder:

1. Center the cylinder on the holder. Wrap the fastening strap around the cylinder and thread the strap through **both** D-rings (inset).
2. Thread the fastening strap back through the inside D-ring (inset).
3. With one hand holding the oxygen bottle in place, firmly pull the loose end of the strap to cinch the fastening straps tight.
4. Repeat to secure the second strap.

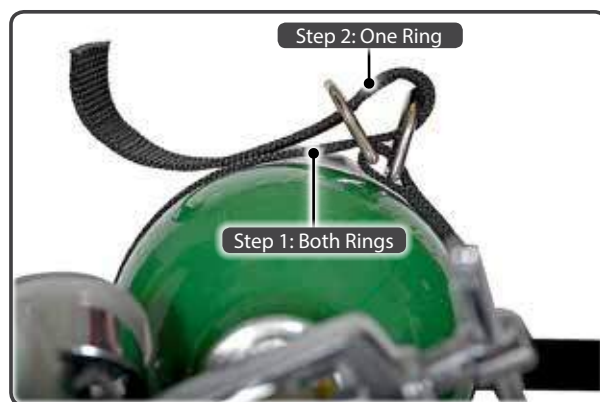



Important

Wheel locks are not a substitute for operator control. The operators must remain with the iNjX and keep control of it at all times. Do not leave the patient unattended.



4.26 Patient Restraint System

The iNjX features a unique patient-restraint system that includes a combination pelvis strap/shoulder harness, chest strap, and two-piece leg restraint (Figure 30).

For instructions on placement, attaching, and using the patient-restraint system, see "Patient Restraints" on page 56.

4.27 Accessory Rail

The main frame of the iNjX acts as an attachment point to secure a variety of accessories to the iNjX (Figure 30). Accessories may be attached to either side of the iNjX, with a few limitations.

For information on attaching, placing and using accessories, see "Accessories" on page 63.

4.28 Wheel Locks

The two wheel locks help keep the iNjX from rolling during patient transfer and certain medical procedures. Wheel locks are attached to the control-end transport wheels.

Press the lock lever down to engage (Figure 31). Press the opposite end of the lock lever to disengage.

- The lock stops the rotation of the wheel when engaged.
- Wheel locks are used to help hold the iNjX stationary. Do not use wheel locks to slow an iNjX while it is being rolled.
- Remain with the iNjX and keep control of it at all times. Do not leave the patient unattended.

5 - USING THE iNjX

5.1 Before Placing the iNjX in Service

- Before use, personnel who will work with the iNjX must read and understand this manual. Appropriate skills and training are also required. See "Operator Training" on page 8.
- Set up the iNjX. Install any accessories shipped with the iNjX. See "Initial Setup" on page 58.
- Confirm that the iNjX operates properly. See "Inspecting the iNjX" on page 48.
- Set the loading height for the ambulance you will use with the iNjX. See "Set the Loading Height" on page 59.

5.2 General Guidelines for Use

- Medical advice and procedural protocol is beyond the parameters of this manual.
- It is the users' responsibility to ensure safe practices for the patient and themselves.
- A minimum of two trained operators is required.
- Follow standard emergency patient-handling procedures when operating the iNjX.
- **Operators must work together** and maintain control of the iNjX at all times.
- **Operators must communicate** with one another and use coordinated movements to operate the iNjX.
- **Operators must stay** with the patient at all times. Do not leave a patient unattended.
- Always use patient restraints to secure the patient on the iNjX.
- Keep the iNjX lowered when the load exceeds the load capacity.
- Lift only the weight you can safely handle. Use additional help when working with heavy loads (patient and equipment). For placement of helpers, see "Using Additional Help" on page 10.
- Press  to activate the iNjX after turning the power ON, or to awaken the iNjX from Sleep Mode. See "Sleep Mode" on page 22.

5.3 Status Indicators and Audible Alarm

The iNjX has two systems to alert the operators to important or unsafe conditions or faults.

- The Status Zone displays a symbol and code indicating the status of the iNjX. See "Status Zone" on page 19 and "Status Indicators" on page 61.
- An audible alarm beeps in a pattern corresponding to the priority of the status code. See "Audible Alarm" on page 19.

WARNING

Improper operation can cause injury. Operate the iNjX only as described in this manual.

An unattended patient can be injured. Stay with the patient at all times.

An unrestrained patient can be injured. Use properly-installed patient restraints to secure the patient on the iNjX.

Rolling the iNjX above the factory-set maximum transport height can cause it to tip. Only roll the iNjX at or below the factory-set maximum transport height.





Load Capacity*

* Operators (and helpers) must provide lift assistance when the load exceeds the load capacity. Inspect the iNjX if the load capacity has been exceeded. See "Inspecting the iNjX" on page 48.

Tip

Press Green to Go

To activate the iNjX after turning the power switch ON, or to wake the iNjX from Sleep Mode, press . Note: Only the  button will activate/wake up the iNjX.

Tip

Audible Alarm

The iNjX beeps when a status indicator is displayed. The severity of the status determines the number of beeps.

WARNING

Uncontrolled movement can cause injury or damage. Support and control the iNjX at all times.

Important

Operators must maintain a firm grasp on the main frame and control the iNjX at all times. Be prepared to help raise or lower the iNjX.

Tip



Press Green to Go

To wake the iNjX from Sleep Mode, press .

Automatic Stops

The iNjX automatically stops at:



- the factory-set maximum transport height
- the user-set loading height

To continue, press  or .

Providing Lift-Assistance



Allow the iNjX to lift the load. The operators and helpers need to provide lift-assistance only when the load exceeds the load capacity.

Auto-Equalize Feature

When  or  is pressed, the iNjX extends or retracts one set of legs until both sets of legs are equally extended. Then, both sets of legs extend or retract simultaneously.

5.4 Powered Extending/Retracting

Extending or retracting the legs with a patient on the iNjX requires a minimum of two trained operators who are communicating, working together, and maintaining control of the iNjX at all times.

1. **Both Operators:** Keep both hands on the iNjX main frame. Maintain control of the iNjX so it does not shift when extending or retracting the legs.
2. **Control Operator:** Press  to activate the iNjX after turning the power ON, or to awaken the iNjX from Sleep Mode.
3. **Control Operator:** Press  or  (Figure 32) until the iNjX reaches the desired height.
4. **Both Operators:** During the position change, both operators (and any helpers) move with the iNjX and maintain their grasp on the main frame.

Note: The color of the display zone assists the operators in understanding the height condition of the iNjX. See "Display Zones" on page 18.

LOAD CAPACITY

The iNjX load capacity is 700 lbs/318 kg. Extremely heavy loads may require assistance from the operators (and any helpers). See "Using Additional Help" on page 10.

If the iNjX will not extend the legs, do the following:

1. **Both Operators and Helpers:** Trained operators stand at opposite ends of the iNjX and use an underhand grip to grasp the main frame. Guide helpers where and how to grasp the iNjX. See "Using Additional Help" on page 10.
2. **Control Operator:** Press  and tell the Loading-end Operator and helpers to help raise the iNjX.
Allow the iNjX to lift the load. The operators and helpers need to provide lift-assistance only for the portion of the load that exceeds the load capacity.
3. **Both Operators and Helpers:** Together, raise the iNjX to the desired height, then hold the iNjX at that position.
4. **Both Operators and Helpers:** Slowly lower your hands to test and verify that the iNjX has stabilized at the new position. Always keep both hands on the main frame and control the iNjX.

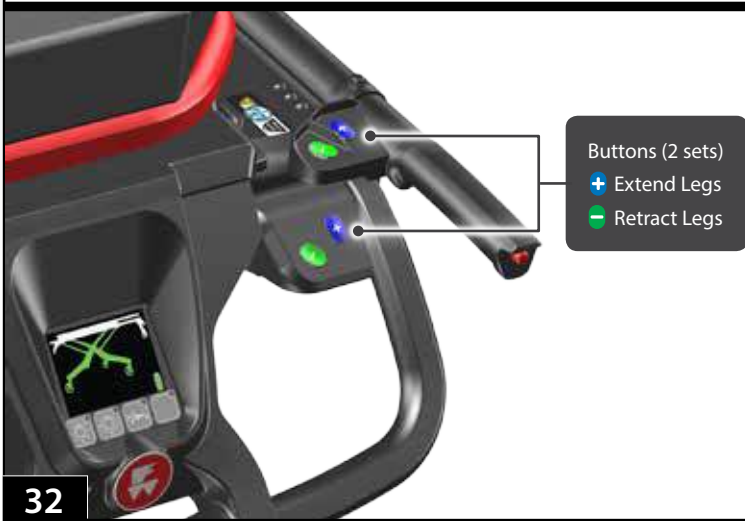

5.5 Transferring the Patient

TRANSFERRING THE PATIENT ONTO THE iNjX

1. Place the iNjX beside the patient. Press **+** or **-** to adjust the iNjX to the patient's level.
2. Lock the wheel locks.
3. Unfasten the patient restraints. Arrange the straps so they will not interfere with transferring the patient onto the iNjX.
4. If needed, rotate the sidearms out of the way.
5. Transfer the patient onto the iNjX using approved emergency-medical procedures and following local protocols.
6. Adjust the backrest, shock frame, and sidearms as needed for patient comfort or medical care.
7. Fasten and adjust the patient restraints (Figure 33).
8. Before moving the iNjX or changing its position, make sure sheets and other articles will not interfere with iNjX operation.
9. Unlock the wheel locks.
10. Press **+** or **-** until the iNjX reaches the desired height. See "Powered Extending/Retracting" on page 33.

With an excessive load (patient plus equipment exceeds the load capacity), the iNjX legs may not extend when a button is pressed, and/or one or both ends of the iNjX may settle downward several inches. See the "load capacity" section in "Powered Extending/Retracting" on page 33.

TRANSFERRING THE PATIENT OFF THE iNjX

To transfer the patient from the iNjX onto another surface, such as a hospital bed:

1. Roll the iNjX near the destination surface. Press **+** or **-** to adjust the iNjX to, or slightly above, the destination surface.
2. Lock the wheel locks.
3. Rotate the sidearms out of the way.
4. Unfasten the patient restraints. Arrange the straps so they will not interfere with transferring the patient off the iNjX.
5. Transfer the patient onto the destination surface using approved emergency-medical procedures and following local protocols.
6. Fasten and arrange the patient restraints so they will not interfere with using the iNjX.
7. Before moving the iNjX or changing its position, make sure sheets and other articles will not interfere with iNjX operation.
8. Unlock the wheel locks.
9. Press **+** or **-** until the iNjX patient surface is at a suitable rolling height. See "Powered Extending/Retracting" on page 33 and "Rolling the iNjX" on page 36.

WARNING

Sheets or other objects can interfere with, or become entangled in, the height-adjustment locking mechanism. This can cause injury and/or malfunction, including unexpected retracting of the iNjX legs. Do not tuck sheets or place other objects where they can interfere with, or become entangled in, the locking mechanism.



33

Tip

Press Green to Go

To wake the iNjX from Sleep Mode, press **-**.



Chair Position

34



35

5.6 Transferring the Patient: Chair Position

The chair position allows a patient to be transferred to a seated position on the iNjX patient surface. Follow local protocols to determine the best situations to use chair position. To place the iNjX in chair position:

1. Roll the iNjX toward the control-end to position all four swivel wheels in the same orientation.
2. Raise the shock frame.
3. Press the chair-position button (Figure 34).

Note: When the chair-position button is pressed, a 15-second timer begins. To cancel, press the chair-position button again or allow the timer to expire.



4. Before the timer expires, press . Maintain control of the iNjX as the legs adjust to place the iNjX in the chair position (Figure 35).
5. Lock the wheel locks.
6. Unbuckle the restraints. If needed, rotate one or both sidearms out of the way.
7. Adjust the backrest to suit the patient.
8. If needed, have one operator or assistant steady the iNjX so it will not move as the patient is seated.
9. Assist the patient onto the iNjX following approved emergency-medical procedures and local protocols.
10. Fasten and adjust the patient restraints.
11. Before moving the iNjX or changing its position, make sure sheets and other articles will not interfere with iNjX operation.
12. Inform the patient before adjusting the iNjX height.
13. Verify the display is not showing the chair position screen: the regular operating screen should appear after the timer expires.
14. Press or until the iNjX reaches the desired height. See "Powered Extending/Retracting" on page 33.
15. Make further adjustments to the backrest, shock frame, and/or sidearms as needed for patient comfort or medical care.
16. Unlock the wheel locks.

5.7 Rolling the iNjX

GUIDELINES

- Rolling the iNjX with a patient on it requires a minimum of two trained operators who are communicating, working together, and maintaining control of the iNjX at all times.
- Roll the iNjX on smooth, unobstructed surfaces whenever possible. To cross a low obstacle such as a threshold, each operator lifts slightly as both operators roll the iNjX across the obstacle. Avoid jarring the patient.
- Roll the iNjX only at or below the recommended transport height. Rolling above this height can increase the chance for the iNjX to tip. An audible alarm sounds when the iNjX is above the maximum transport height.
- Do not roll the iNjX sideways. Rolling the iNjX sideways can increase the chance for it to tip and injure the patient and/or operators.
- Use additional help as needed to safely control the weight of the patient and iNjX. See "Using Additional Help" on page 10.

ROLLING THE iNjX

1. Fasten and adjust the patient restraints.
2. **Control-end Operator:** Press  or  to adjust the iNjX height until the patient surface is at or below the factory-set maximum transport height.
3. **Both Operators:** Position both operators at the sides of the iNjX. Grasp and maintain control of the iNjX using the main frame. If additional help is used, position the helpers at the sides of the iNjX and the operators at the control and loading ends. See "Using Additional Help" on page 10.

WARNING

Rolling the iNjX above the factory-set maximum transport height can cause it to tip. Only roll the iNjX at or below the factory-set maximum transport height.

Rolling the iNjX sideways can cause it to tip. Roll the iNjX only toward the control end or loading end.

Important

Roll the iNjX downhill control-end first. If it is not medically appropriate to do this, roll with the loading-end first, but to maintain balance, the Loading-end Operator must exert upward force on the main frame.

Operating the iNjX requires a minimum of two trained operators. They may need additional help when working with heavy loads (patient plus equipment) or when operating the iNjX manually. See "Using Additional Help" on page 10.

Rolling

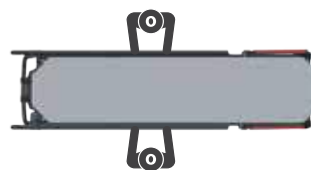

Tip

Talk to the Patient

Reassure the patient. Communicate before adjusting the height and during the loading and unloading processes.

Full 360° Movement

The iNjX allows full maneuverability at any height, even when fully folded.

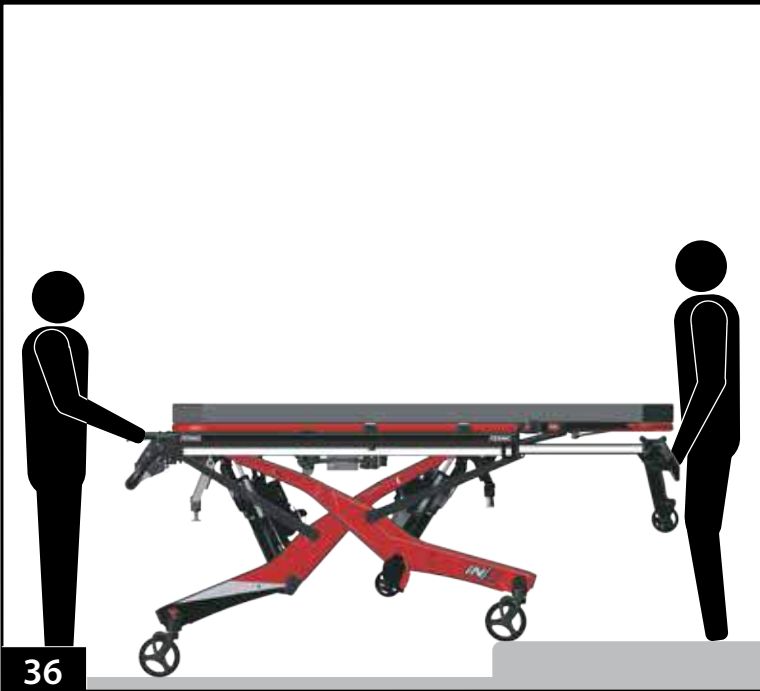

36

Do Not Lift the iNjX

After the iNjX is secured by the safety hook, allow the iNjX legs and iNjLINE to hold the weight.

Tip

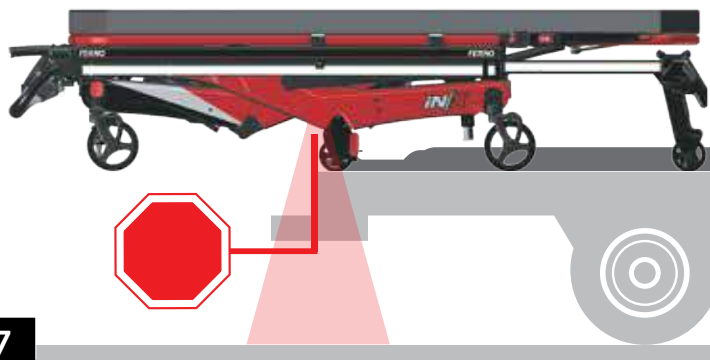

37

CROSSING HIGH OBSTACLES

The operators can use the iNjX auto-equalize feature to cross high obstacles such as curbs and some steps. Use additional help if needed; see "Using Additional Help" on page 10.

To cross a high obstacle:

1. **Both Operators:** Roll the iNjX to the obstacle, with one set of transport wheels at the edge of the obstacle. Position the operators at the loading and control ends of the iNjX.
2. **Operator Nearest the Obstacle:** Position yourself on firm ground on the destination side of the obstacle. Support the load of your end of the iNjX (use additional help as needed). Do not lift.
3. **Control Operator:** Press **+** or **-** to adjust the height. The iNjX will stop when the leg nearest the obstacle is no longer supporting weight.
4. **Operator Nearest the Obstacle:** Continue to support the weight of your end of the iNjX. Do not lift.
5. **Control Operator:** Press **+** or **-** to adjust the height of the set of legs that will cross the obstacle. Stop when the transport wheels are at the appropriate height to cross or roll onto or over the obstacle.
6. **Both Operators:** Together, roll the iNjX partway onto the new surface (Figure 36). The operator nearest the obstacle can relax his/her grasp when the iNjX is fully supported on the new surface. Continue rolling the iNjX to position the second operator near the obstacle.
7. **Both Operators:** Repeat Steps 2-6 with the control-end operator supporting the load, adjusting the iNjX legs, and with both operators maneuvering the iNjX over the obstacle and/or onto the new surface.

5.8 One Operator, Empty iNjX

If local protocols permit, an empty iNjX (no patient) may be operated by one trained operator. Always use two operators when a patient is on the iNjX.

Raising/Lowering: Press **+** or **-** to adjust the iNjX height.

Loading and Unloading: Follow the procedures as for two operators. See "Loading the iNjX" on page 38 or "Unloading the iNjX" on page 40.

Guide the iNjX toward the iNjLINE so the safety hook will catch the center of each safety bar during loading or unloading. Use the position indicator lights to assist you in the proper times to extend or retract the control-end legs (Figure 37).

Reminder: Do not lift. After the iNjX is secured by the safety hook, allow the iNjX legs and iNjLINE to hold the weight. Raise and lower legs as needed.

5.9 Loading the iNjX

Loading the iNjX into an ambulance with a patient on it requires a **minimum** of two trained operators who are communicating, working together, and maintaining control of the iNjX at all times. Use additional help if needed; see "Using Additional Help" on page 10.



1. Raise the ambulance folding bumper, if present.
2. Extend the telescoping load frame and verify it is locked in the fully-extended position.
3. **Both Operators:** Grasp the iNjX with both hands.
4. **Control-end Operator:** Press **+** to raise the iNjX to the user-set loading height (see "Set the Loading Height" on page 59) or, if needed, press **+** and **-** to position the loading wheels level with the ambulance floor.
5. **Both Operators:** Align the iNjX with the iNjLINE, then roll the iNjX into the ambulance until the loading wheels and load-frame safety bar pass the safety hook (Figure 38).
6. **Loading-end Operator:** Visually confirm the safety bar has been captured by the hook.
7. **Both Operators:** Confirm the iNjX is secure by attempting to pull the iNjX out of the ambulance. The iNjX must be stopped by the safety hook (Figure 39). If not, adjust the height and retry.
8. **Control-end Operator:** Press **-** to begin retracting the loading-end legs. The legs will retract slightly, then stop when they are no longer supporting the weight of the iNjX. This is a safety check to verify that the load is being supported.
9. **Control-end Operator:** The display shows the loading-end legs green (ready to retract) and control-end legs white (will not retract). Press **-** and completely retract the loading-end legs (Figure 40).

Note: The iNjX has a leg "kick-up" feature to position the control end slightly above the level of the ambulance floor. This feature helps aid a smooth transition into the ambulance and reduces bumps for the patient and operators as each set of wheels rolls into the ambulance.

Talk to the Patient

Reassure the patient. Communicate before adjusting the height and during the loading and unloading processes.

No-Lift Loading/Unloading

Do not lift the iNjX off the ground when using power during the loading or unloading process. See "No-Lift Loading/Unloading" on page 9.

Tip

WARNING

Failure to engage the safety hook during loading or unloading can cause injury. Operators must visually ensure each safety bar engages the safety hook and the iNjX is secure inside the ambulance before extending or retracting the legs.

Important

If the ambulance is parked on an uneven surface, the operators (and any helpers) may need to extend the legs higher than the user-set loading height to allow the iNjX to roll into the ambulance.

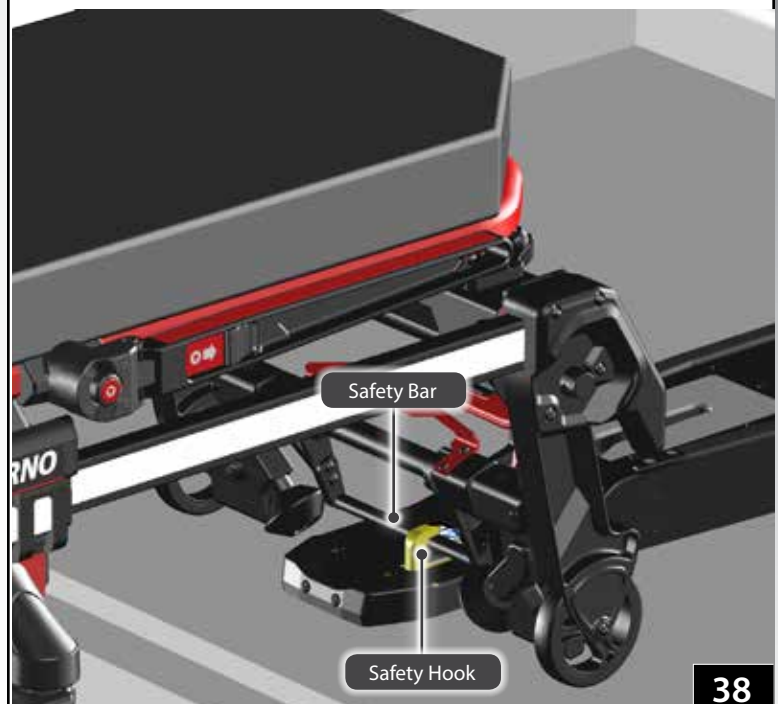

38



39

Using the iNjX

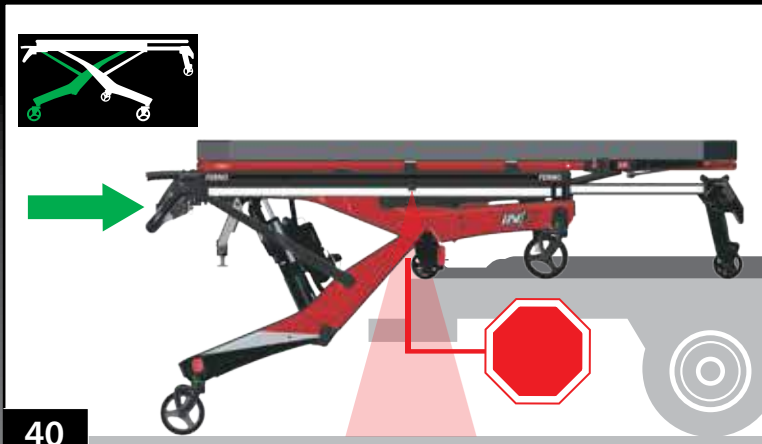

40

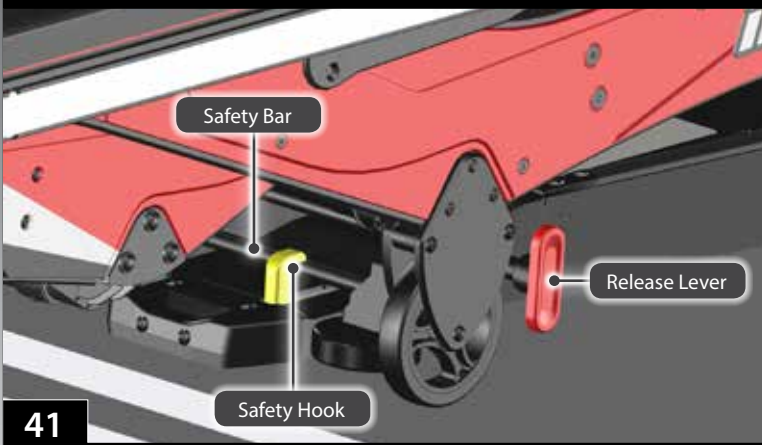

41

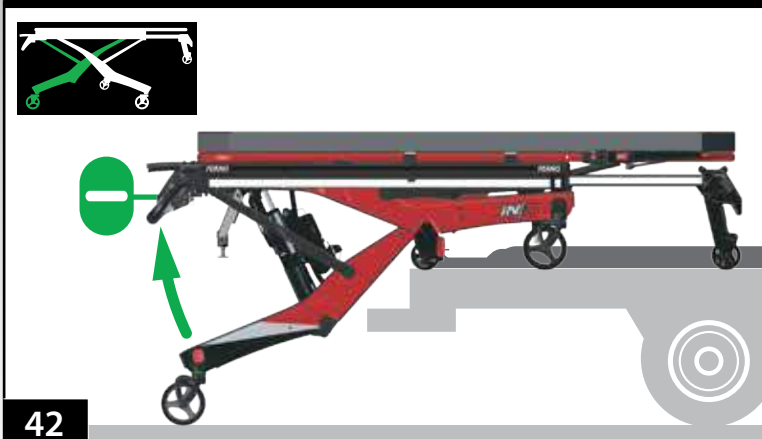

42



43

10. **Both Operators:** Push the iNjX into the ambulance until the intermediate wheels and position indicator lights are on the ambulance floor and the intermediate safety bar passes the safety hook, then stop (Figure 41). Press to lower the intermediate wheels to the floor.
11. **Loading-end Operator:** Visually confirm the intermediate safety bar has captured the safety hook. If needed, use the release lever to lift the safety bar over the safety hook, and then lower the safety bar to engage the safety hook (Figure 41).
12. **Both Operators:** Pull the iNjX against the safety hook to confirm the intermediate safety bar has been captured by the hook.
13. **Control-end Operator:** Press to begin retracting the control-end legs (Figure 42).
Note: The legs will retract slightly, then stop when they are no longer supporting the weight of the iNjX. This is a safety check to verify that the load is being supported.
14. **Control-end Operator:** Press to finish retracting the control-end legs.
15. **Both Operators:** Push the iNjX into the ambulance (Figure 43) until the rear fastening post locks in the iNjLINE.

Legs Pause (Loading Process)

Each set of legs will retract slightly and then stop retracting when they are no longer supporting the weight of the iNjX. This is a safety check to verify the weight is supported by the ambulance and/or operator(s).

Position Indicator Lights

When the red line is visible on the ambulance floor, the intermediate loading wheels are also on the ambulance floor, indicating it is safe to retract the control-end legs.

Use the Telescoping Handles

Extend the telescoping handles to more easily maneuver the iNjX into the iNjLINE and reduce the amount of reaching required. Retract the handles before closing the ambulance rear doors.

Tip

5.10 Unloading the iNjX

Unloading the iNjX from an ambulance with a patient on it requires a **minimum** of two trained operators who are communicating, working together, and maintaining control of the iNjX at all times. Use additional help if needed; see "Using Additional Help" on page 10.



1. **Either Operator:** Raise the ambulance folding bumper, if present.
2. **Control-end Operator:** Press the iNjLINE release button to unlock the iNjX from the iNjLINE, roll it a few inches from the ICS contacts, then press to activate the iNjX.
3. **Both Operators:** Grasp the iNjX with both hands and roll the iNjX out of the ambulance until the safety hook captures the center of the intermediate safety bar (Figure 44).
4. Visually confirm that the safety bar has been captured by the safety hook.
5. **Control-end Operator:** Press to extend the control-end legs (Figure 45).

Tip

Press Green to Go

Unlock the iNjX from the iNjLINE, roll it a few inches from the ICS contacts, then press to activate the iNjX.

Talk to the Patient

Reassure the patient. Communicate before adjusting the height and during the loading and unloading processes.

No-Lift Loading/Unloading

Do not lift the iNjX off the ground when using power during the loading or unloading process. See "No-Lift Loading/Unloading" on page 9.

Position Indicator Lights

When the red line is visible at the edge of the ambulance floor and the safety bar is engaged with the safety hook, the control-end legs are ready to be extended.

WARNING

Failure to engage the safety hook during loading or unloading can cause injury. Operators must visually ensure each safety bar engages the safety hook and the iNjX is secure inside the ambulance before extending or retracting the legs.

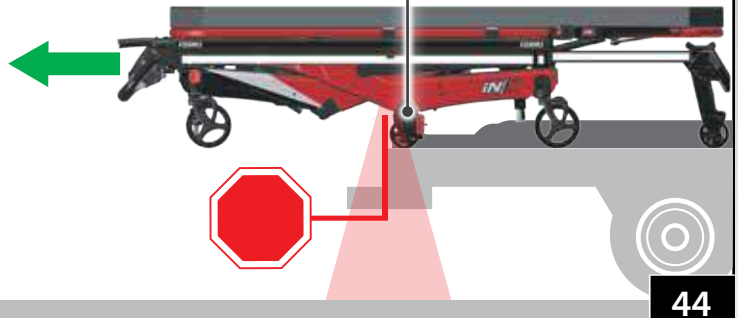
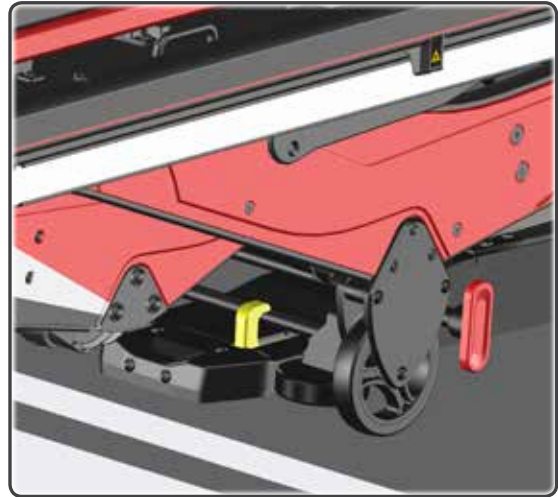

44



45

Using the iNjX

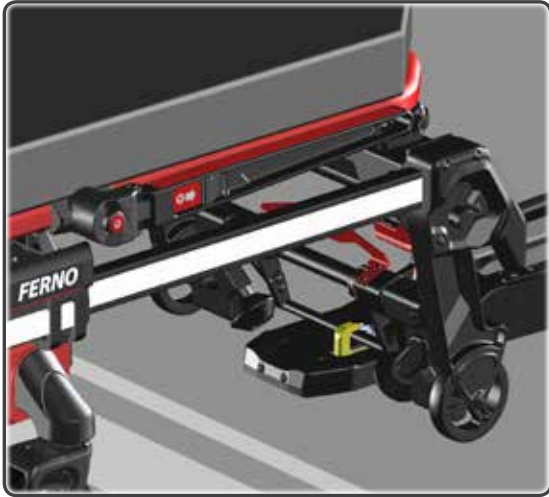

46



47

6. **Control-end Operator:** Tell the Loading-end Operator to disengage the intermediate safety bar from the safety hook.
7. **Both Operators:** Roll the iNjX out of the ambulance until the safety hook captures the center of the loading-frame safety bar (Figure 46).
8. **Control-end Operator:** Press **+** to extend the loading-end legs (Figure 47).
9. **Control-end Operator:** Tell the Loading-end Operator to disengage the load-end safety bar from the hook.
10. **Both Operators:** While maintaining your grasp on the main frame and guide bar with both hands, roll the iNjX out of the ambulance, then stop rolling.
11. **Control-end Operator:** Press **-** to lower the iNjX to the factory-set transport height.

5.11 Direct Power Modes

Manual-power modes allow the operators to independently control one or both sets of legs to raise, lower, load or unload the iNjX. Use the mode button to select from three manual-power modes. Direct Power is a secondary method of operating the iNjX. They are not part of normal operation.



Note: If an obstruction prevents the iNjX from moving, stop pressing or , carefully remove the obstruction, and continue using the iNjX. Direct power is not needed.

Note: When using Direct power, the iNjX extends and retracts the legs at a slower speed than when using the normal powered mode.

SELECTING DIRECT POWER

Each button press cycles to the next mode. The button-press sequence is:

- **Direct Power Both Legs.** Both sets of legs move when or is pressed. Depending on the weight on the iNjX, one set of legs may extend or retract more quickly than the other.
- **Direct Power Loading-end Legs Only.** Only the loading-end legs move when or is pressed.
- **Direct Power Control-end Legs Only.** Only the control-end legs move when or is pressed.

Note: The fourth button-press enters the Load-Height Set Mode. See "Set the Loading Height" on page 59.

Note: The fifth button-press returns the iNjX to its standard operating mode.

USING DIRECT POWER

Use care when using direct power with a patient on the iNjX.

In Direct Power, the auto-equalize feature is disabled. The iNjX will not automatically match or maintain an even extension between the loading-end and control-end legs.

Avoid placing the patient at a severe angle as patient and/or operator injury can occur if the load shifts.

Use additional help if needed; see "Using Additional Help" on page 10.

In each direct power mode, a countdown timer counts down from 15 seconds. If no further action is taken, the iNjX reverts to its standard operating mode.

WARNING

A severe angle can injure the patient and/or operators. Control the iNjX when using a direct power mode.

Important

When using direct power, the auto-equalize feature is disabled. Do not place the iNjX at a severe angle where the patient or equipment could shift and become unbalanced.

Tip

Direct Power Modes

The direct power modes are easily identified by the icons and white background on the display screen.

During normal operation, the display background remains black.

Use additional help if needed; see "Using Additional Help" on page 10.

Return to Normal Operation

To return to the standard or normal operating mode, wait for the 15-second timer to expire while on any alternate mode screen, or cycle the mode button until the normal screen appears.



48

5.12 Direct Power: Both Legs

In this mode, both sets of legs move when **+** or **-** is pressed. Be aware:

- Auto-equalize is off. Operators must maintain control of the iNjX. Do not put the patient at a severe angle.
- The weight of the patient and equipment may cause the legs to move at different speeds.
- Display (Figure 48):
 - White background
 - Blue legs and double-headed arrows indicates both legs will move.
 - Red wheels indicate that the iNjX must not be rolled.
 - If the 15-second countdown timer expires, the iNjX returns to its standard operating mode.

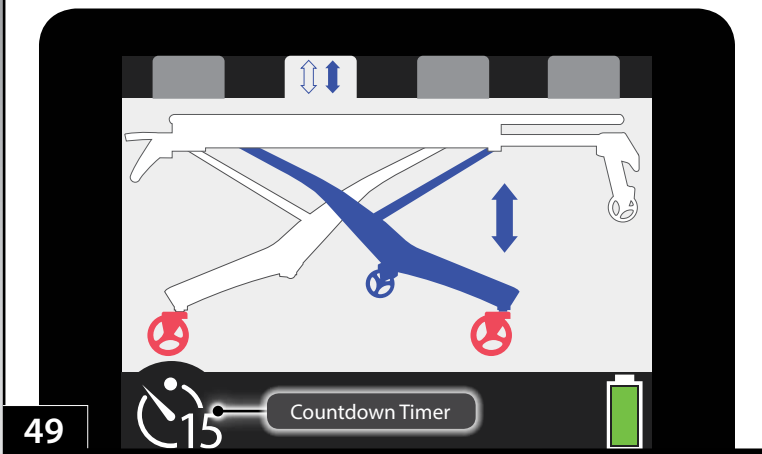

49

5.13 Direct Power: Loading-End Legs

In this mode, only the loading-end legs move when **+** or **-** is pressed. Be aware:

- Auto-equalize is off. Operators must maintain control of the iNjX. Do not put the patient at a severe angle.
- Display (Figure 49):
 - White background
 - Blue loading-end legs and double-headed arrow indicates only the loading-end legs will move.
 - Red wheels indicate that the iNjX must not be rolled.
 - If the 15-second countdown timer expires, the iNjX returns to its standard operating mode.

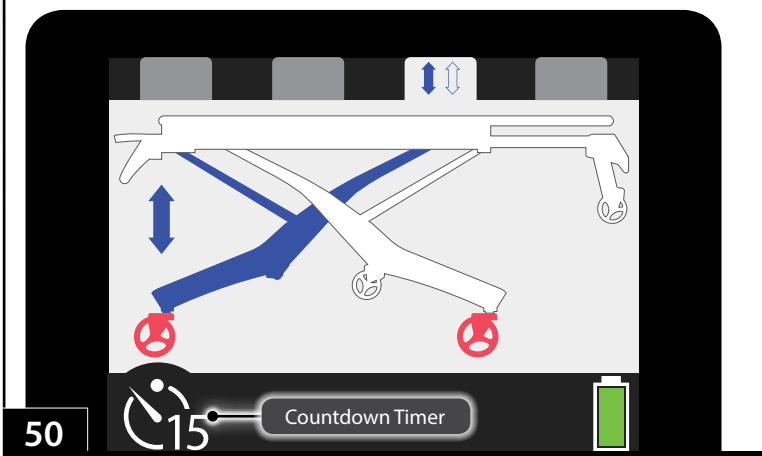

50

5.14 Direct Power: Control-End Legs

In this mode, only the control-end legs function when **+** or **-** is pressed. Be aware:

- Auto-equalize is off. Operators must maintain control of the iNjX. Do not put the patient at a severe angle.
- Display (Figure 50):
 - White background
 - Blue control-end legs and double-headed arrow indicates only the control-end legs will move.
 - Red wheels indicate that the iNjX must not be rolled.
 - If the 15-second countdown timer expires, the iNjX returns to its standard operating mode.

5.15 Non-Powered Operation: Extending and Retracting

To extend or retract the iNjX legs without power, adjust each leg individually and by a small amount. Repeat until the iNjX is at the desired height. Use additional help if needed; see "Using Additional Help" on page 10.



USING TWO OPERATORS:

PREPARING TO EXTEND OR RETRACT

1. **Both Operators:** Stand together at one end of the iNjX and grasp the main frame. Communicate and work together while extending or retracting the legs. Do not place the patient at a severe angle.
2. **Both Operators:** Raise the backrest and shock frame (Figure 51) as needed. Release the actuator-release handles from their mounts.
3. **Lead Operator:** Grasp the main frame with both hands, support and balance the iNjX.
4. **Handle Operator:** Be ready to use the actuator-release handle at the proper time and assist with extending or retracting the legs.

EXTENDING

1. **Lead Operator:** Raise the end of the iNjX several inches off the ground. Tell the handle-operator you are ready for the position change.
2. **Handle Operator:** Squeeze the actuator-release handle (Figure 52) and push the legs down until the transport wheels are on the ground. Release the handle to lock the legs.
3. **Lead Operator:** Maintain your grasp on the iNjX. Verify it is stable at the new position.
4. **Both Operators:** Move to the opposite end of the iNjX and repeat Steps 1-3.
5. **Both Operators/Helpers:** Repeat Steps 1-4 until the iNjX is level and is at the desired height.

Tip

Control the Load

Lift the iNjX slightly before squeezing an actuator-release handle. This ensures that you have assumed the load.

Non-Powered Recommendation

When extending the iNjX without power, Ferno recommends you begin at the loading end. Raise the loading end first, then the control end.

WARNING

Uncontrolled movement can cause injury or damage. Support the load before using an actuator-release handle.

A severe angle can injure the patient and/or operators. Control the iNjX when operating without power.



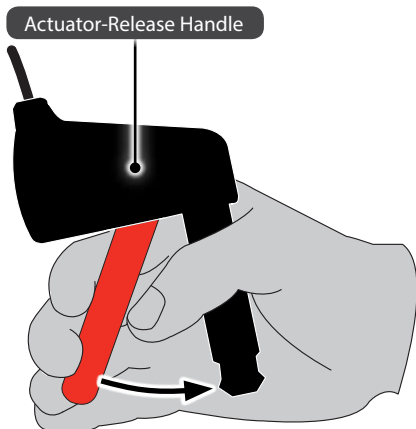

Tip

Deploying the Handles

Push the base of the actuator-release handle to remove it from its mount. Position the loading-end handle at the patient-right side of the iNjX, and the control-end handle at the patient-left side.

Non-Powered Recommendation

When retracting the iNjX without power, Ferno recommends you begin at the control end. Lower the control end first, then the loading end.

Raising and Lowering (with Patient)

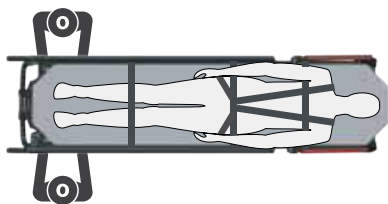
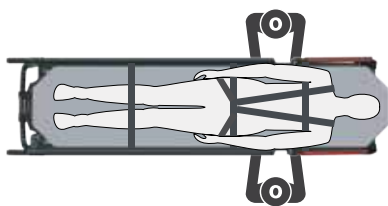

Raising and Lowering (No Patient)



RETRACTING

1. **Lead Operator:** Lift slightly and assume the load (example: lift until the wheels are off the ground slightly). Communicate to the handle-operator that you are ready for the position change.
2. **Handle Operator:** Grasp the main frame and handle.
3. **Both operators:** As the handle operator squeezes the handle, both operators assist the retracting process. Release the handle to lock the legs.
4. **Lead Operator:** Maintain your grasp on the iNjX. Verify it is stable at the new position.
5. **Both Operators:** Move to the opposite end of the iNjX and repeat Steps 1-4.
6. **Both Operators:** Repeat Steps 1-5 until the iNjX is level and is at the desired height.

FOLDING WITHOUT A PATIENT

To fold the iNjX with no patient, the operators stand at opposite ends of the iNjX and squeeze the handles at the same time. Control the descent of the iNjX and keep it level as you fold it.

5.16 Non-Powered Operation: Loading

The independent-leg design of the iNjX allows the operators to reduce the amount of lifting required even when loading the iNjX into an ambulance without power. Refer to the table at right and use additional help as needed. See "Using Additional Help" on page 10.



1. **Both Operators:** Raise the iNjX to the loading height for your ambulance. See "Non-Powered Operation: Extending and Retracting" on page 44 to raise the iNjX in stages until it is the desired height. Do not put the patient at an extreme angle.
2. **Both Operators:** Roll the iNjX into the ambulance and secure the loading-end safety bar on the safety hook. Verify the iNjX is engaged with the hook before proceeding.
3. **Handle Operator:** Remove the loading-end actuator-release handle from its mount under the backrest.
4. **Both Operators:** Stand together at the loading end of the iNjX. Grasp the main frame with one hand and the loading-end legs with the other hand.
5. **Both Operators:** Communicate and work together. As the handle operator squeezes the actuator-release handle, both operators retract the loading-end legs. Release the handle to lock the legs.
6. **Both Operators:** After retracting the loading-end legs, resume your grasp on the main frame.
7. **Both Operators:** Roll the iNjX into the ambulance until the intermediate safety bar passes the safety hook. Verify that the iNjX is engaged with the hook before proceeding.
8. **Handle Operator:** Squeeze the actuator-release handle one more time to verify the loading-end legs have completely retracted. Position the handle out of the way so it will not interfere with the iNjLINE.
9. **Handle Operator:** Remove the control-end actuator-release handle from its mount under the shock frame.
10. **Both Operators:** Stand together at the control end of the iNjX. Grasp the main frame with one hand and the control-end legs with the other hand.
11. **Both Operators:** Communicate and work together. As the handle operator squeezes the actuator-release handle, both operators retract the control-end legs. Release the handle to lock the legs.
12. **Both Operators:** Resume your grasp on the main frame, then roll the iNjX into the ambulance and secure it in the iNjLINE.

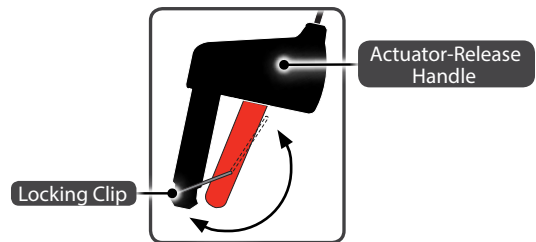
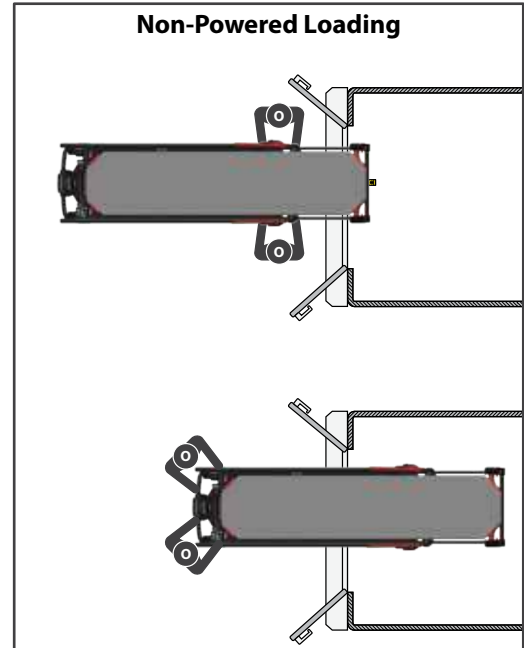

Important

As you load the iNjX control-end into the ambulance, arrange the actuator-release handles and cables so they will not interfere with the iNjLINE.

Tip

Reduce the Load

If medically appropriate, lower the backrest and lay the patient flat. This puts more of the load inside the ambulance and reduces the amount the operators must support during loading.

Urgent Non-Powered Loading

If enough operators and helpers are available, roll the iNjX to the ambulance and fully retract both sets of legs. Working together, the operators and helpers lift and set the iNjX inside the ambulance.

Using the Locking Clip

Use the locking clip (illustrated above) to hold the handle in the compressed state. This allows the handle operator to use both hands to maintain control of the iNjX during non-powered loading and unloading.

Non-Powered Unloading

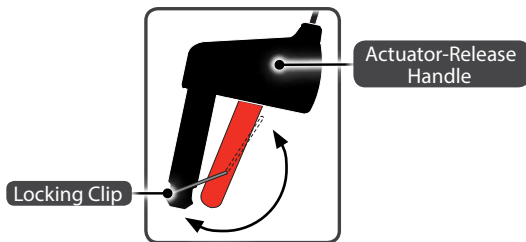
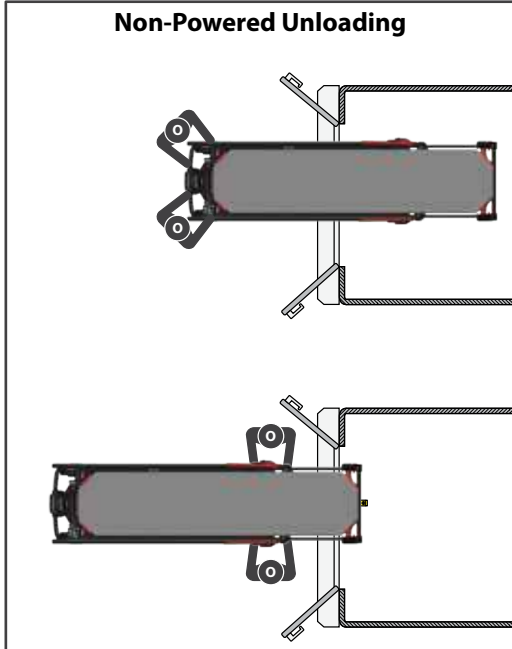

Tip

Non-Powered Unloading

When using the non-powered unloading process, the iNjX is not at its normal height. The operators and patient may experience a slight bump when the iNjX is released from the safety hook. Both operators should lift the iNjX slightly as it is rolled out of the ambulance.

Urgent Non-Powered Unloading

If enough operators and helpers are available, work together to roll the iNjX out of the ambulance without extending the legs and set it on the ground. Then, raise the iNjX for rolling.

Using the Locking Clip

Use the locking clip (illustrated above) to hold the handle in the compressed state. This allows the handle operator to use both hands to maintain control of the iNjX during non-powered loading and unloading.

5.17 Non-Powered Operation: Unloading

The independent-leg design of the iNjX allows the operators to reduce the amount of lifting required even when unloading the iNjX from an ambulance without power. Refer to the table at left and use additional help as needed. See "Using Additional Help" on page 10.



1. **Either Operator:** Remove the control-end actuator-release handle from its mount under the shock frame.
2. **Both Operators:** Support and balance the load as the iNjX is rolled out of the ambulance in Step 3.
3. **Both Operators:** Disengage the iNjX from the iNjLINE and roll it out of the ambulance until the intermediate safety bar engages the safety hook. Verify the safety bar is engaged with the hook before proceeding.
4. **Both Operators:** Use additional help as needed to support the load.
5. **Handle Operator:** Squeeze the actuator-release handle and extend the control-end legs to the ground. Release the handle to lock the legs in the extended position.
6. **Both Operators:** As one operator disengages the intermediate safety bar from the safety hook, both operators roll the iNjX out of the ambulance until the loading-end safety bar engages the safety hook. Verify the iNjX is engaged with the safety hook before proceeding.
7. **Handle Operator:** Remove the loading-end actuator-release handle from its mount under the backrest.
8. **Both Operators:**
 - **Lead Operator:** Support and balance the load throughout the process.
 - **Handle Operator:** Squeeze the actuator-release handle and extend the loading-end legs to the ground. Release the handle to lock the legs in the extended position.
9. **Either Operator:** Disengage the iNjX from the safety hook. Together, roll the iNjX out of the ambulance.
10. **Both Operators:** Lower the iNjX to a transport height, or fold it. See "Non-Powered Operation" on page 27 to lower each end of the iNjX in stages, repeating the process until the iNjX is the desired height. Do not put the patient at an extreme angle.

6 - MAINTENANCE

6.1 Maintenance Schedule

The iNjX requires regular maintenance. Set up and follow a maintenance schedule. The table at right represents minimum intervals for maintenance. Keep maintenance records. See "Maintenance Record" on page 65.

When using maintenance products, follow the manufacturers' directions and read the manufacturers' material safety data sheets.

6.2 Service Life

Many factors affect a product's service life, including frequency of use (high versus low volume ambulance service); local environment (extreme temperature, high humidity, etc.); maintenance (adherence to the inspection and maintenance schedule); and other factors.

Follow the disinfecting, cleaning, and inspection procedures in this manual to ensure long life for the iNjX.

6.3 Inspecting the iNjX

A basic inspection is recommended at the beginning of each operator shift. See "Daily Operator Duties" on page 9.

Inspect the iNjX regularly. See "Maintenance Schedule" on page 48. Have your service's equipment maintenance personnel follow the checklists at right and operate the iNjX through all its functions as described in this manual. If inspection shows damage or excessive wear, contact Ferno. See "Ferno Customer Relations" on page 2.

ELECTRICAL INSPECTION

- Does the power switch function properly?
- Do the Extend and Retract buttons function properly?
- Does the powered system operate properly through the full range of motion?
- Does the powered system operate smoothly, without binding or excessive noise?
- Does the controller stop the iNjX at the transport height, user-set loading height, and at the fully-extended and lowered positions?
- Do the lights and position indicator lights operate as expected?
- Is there visible sign of damage to the controller case, display, battery, or battery charger?
- Does the battery attach properly to the iNjX?
- Does the display function properly?
- Are all cords and cables free of excessive wear, cuts, and fraying?

WARNING

Improper maintenance can cause injury. Maintain the iNjX only as described in this manual.

| Minimum Maintenance | Each Use | As Needed | Monthly |
|---|----------|-----------|---------|
| Inspecting (page 7, page 46) | • | | • |
| Disinfecting (pages 47-48) | • | | |
| Cleaning (pages 47-48) | | • | |
| Lubricating (page 49) | | • | |
| Check and Adjust Actuator Release Handle Cable Tension (page 50) | | • | • |

MECHANICAL INSPECTION

- Are all components present?
- Is the iNjX free of excessive wear?
- Is all hardware securely in place?
- Do all moving parts operate smoothly and properly?
- Does the iNjX load and unload properly?
- Does the safety hook engage each safety bar?
- Do the legs show signs of wear or damage?
- Does the iNjX roll smoothly?
- Do the wheels show excessive wear or damage?
- Do the wheel locks engage properly and stop wheel rotation?
- Do the wheel casters remain level and perpendicular to the ground through 360° rotation and through the full range of leg motion?
- Are the patient restraints properly installed?
- Is restraint webbing in good condition with no cuts or frayed edges?
- Are restraint buckles free of visible damage and do they operate properly?
- Is the ambulance properly prepared for the iNjX with an iNjLINE installed?
- Do installed accessories operate properly without interfering with iNjX operation?

Important

Disinfectants and cleaners containing phenolics or iodines can cause damage. Do not use products containing these chemicals. If bleach is used, rinse with plenty of clear water to remove bleach residue.

Using abrasive cleaning compounds or applicators on the iNjX can cause damage. Do not use abrasive materials to clean the iNjX.

Metal buckles and slide bars can be damaged by immersion in liquids or by washing-machine action. Disinfect and clean only as described in this manual.

Ingress Protection Rating

The iNjX is rated **IP 56**. IP stands for Ingress Protection, and indicates the iNjX has been tested in compliance with dust and water infiltration standards.

Solid Particle Protection (Rating: 5): Dust-protected

Liquid Ingress Protection (Rating: 6): Protected against water infiltration

The IP Rating system was developed by the European Committee for Electrotechnical Standardization (CENELEC) to show compliance of ANSI/IEC 60529, Degrees of Protection Provided by Enclosures (IP Code).

6.4 Disinfecting Patient Restraints

1. Remove the patient restraints from the iNjX.
2. Spray the metal buckles and slide bars with a disinfectant cleaner, following the disinfectant manufacturer's instructions for application method and contact time. **Do not immerse the buckles or slide bars in liquid.**
3. Hang the restraints to air-dry if needed. Attach only dry restraints to the iNjX. See "Patient Restraints" on page 56.

6.5 Cleaning Patient Restraints

1. Immerse the restraint webbing in a solution of mild soap and water. **Do not immerse the metal buckles or slide bars in the solution.**
2. Repeatedly dip the webbing in clear water to rinse. **Do not immerse metal buckles or slide bars in liquid.**
3. Hang the restraint to air-dry. Attach only clean, dry restraints to the iNjX. See "Patient Restraints" on page 56.

6.6 Disinfecting/Cleaning the Pad

1. Remove the pad from the iNjX.
2. **To disinfect:** Apply disinfectant to the pad, following the disinfectant manufacturer's instructions for application method and contact time.
3. **To clean:** Wash the pad with warm, soapy water and a soft cloth. Rinse the pad with clear water. Hang the pad to dry, or dry it with a towel. To attach the pad to the iNjX, see "Locking Pad" on page 28.

6.7 Disinfecting the iNjX

Wipe all surfaces with disinfectant. Follow the disinfectant manufacturer's instructions for application method and contact time. Inspect the iNjX for damage as you disinfect it.

6.8 Cleaning the iNjX

1. Remove the patient restraints, pad, and accessories. Verify that all cords, cables, connectors, etc. are connected.
2. Remove the battery. Cover the battery cable plug with a bag. Tie the bag closed or use a rubber band to make a watertight seal around the plug.
3. For battery care, see "Battery" on page 20 and the Battery Care Important box at right.
4. Hand clean all surfaces of the iNjX with warm water and a mild detergent, or pressure-wash the iNjX as described below. Do not spray water directly into ports, wire harnesses, cable connections, etc.
5. Rinse with warm, clear water. Dry the iNjX with a towel or allow it to air-dry.

6.9 Pressure-Washing the iNjX

Use caution when using pressurized water, spray-wands and equipment when cleaning the iNjX. Wear all safety equipment recommended by the pressure-sprayer manufacturer.

PREPARING TO PRESSURE-WASH

1. Raise or lower the iNjX to the recommended transport height. Then, use direct power (see "Direct Power Modes" on page 42) to fold the loading-end legs until the loading wheels are on the ground (Figure 53).
2. Turn the power switch OFF.
3. Engage the wheel locks.
4. Remove the battery cover and battery from the iNjX (see "Battery" on page 20).
5. Cover the end of the battery cable with a plastic bag, and close the bag. Use a tie wrap or rubber band to make the bag water-tight (Figure 53).
6. Put the battery cover in place.

PRESSURE-WASHING THE iNjX

1. Set the nozzle pressure at or below 3000 psi (20,684 kPa). Ferno recommends you use a nozzle with a wide angle of spray (25° or 40°). Keep the nozzle at least 18 inches (457 mm) away from the iNjX at all times. Do not spray directly into the control panel or wiring.
2. Spray the patient surface, legs, and wheels of the iNjX.
3. Allow the iNjX to sit idle to dry for 10 minutes.
4. Remove the battery cover, tie wrap or rubber band and bag from the battery cable. Attach the battery and put the cover in place.
5. Turn the power switch ON and raise or lower the iNjX to the desired height.
6. When fully dry, reattach the pad, restraints, and accessories.

Battery Care

The battery is water-resistant. Do not submerge the battery in water. Do not open the sealed battery case. Do not dismantle, open or shred the battery.

Wipe the battery terminals with a clean dry cloth if they become dirty or wet.

Before washing or pressure-washing the iNjX, remove the battery and cover the battery cable plug with a bag.



53

Important

The iNjX is water-resistant.

- **DO: Remove the battery.** Cover the battery cable with a plastic bag. Close the bag with a wire tie or rubber band.
- **DO:** Keep the nozzle pressure setting at 3000 psi/20,684 kPa or less and 4 gallons per minute/15 liters per minute or less.
- **DO:** Keep the nozzle at least 18 inches/457 mm from the surface of the iNjX at all times during cleaning.
- **DO:** Reduce water pressure or increase the distance (more than 18 inches/457 mm) when cleaning the display.
- **DO NOT:** Spray water upward into the cables or forcibly at or around the display.

Important

Lubricating parts that should not be lubricated allows dirt and foreign particles to collect on those parts, resulting in damage. Lubricate **only** the numbered reference points shown.

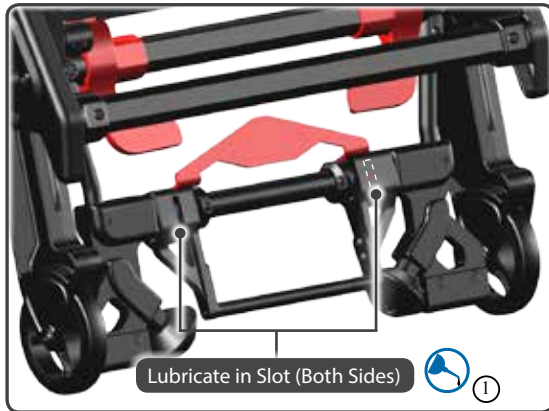

6.10 Lubricating the iNjX

Disinfect and clean the iNjX before applying lubricant. Use the lubricants designated below to lubricate. Do not lubricate points marked with the “do not lubricate” symbol.

LUBRICATION POINTS

| | | |
|----|-----------------------|--------------------------------|
| 1. | Safety Bar Pivot (x2) | WRL-191S, E-Z-1 light oil |
| 2. | Slider Rails | PTFE* dry-film spray lubricant |

LUBRICATION-FREE ITEMS

| | | |
|--|--------------------------|------------------|
| | Wheels (sealed bearings) | Do not lubricate |
| | Legs | Do not lubricate |
| | Patient Surface | Do not lubricate |

Safety-Bar Pivot Points: Apply a few drops of lubricant as needed (near the red handle). Wipe off any excess.

Sliding Rails: If the sliding rails squeak during use, clean the rails. If this does not solve the problem, clean and then apply a light coating of PTFE dry-film spray lubricant to the rails.

*PTFE is the generic name of products similar to Teflon® (a registered trademark of the DuPont Company, E. I. du Pont de Nemours and Company or its affiliates.)



Do Not
Lubricate



Lubricate

Tip

Applying Lubricant

Use a small amount of lubricant (one or two drops). Lubricate identical points on each side of the iNjX. After applying lubricant, wipe off any excess.

6.11 Adjusting Backrest Control Handle Tension

The cable attached to the backrest control handle may require occasional adjustment to retain proper function. If the control handle activates too quickly or too slowly, adjust the tension on the cable.

KNOWING WHEN ADJUSTMENT IS NEEDED

- If the backrest lowers without operating the control handle, the cable is too tight. Decrease tension on the cable.
- If the backrest does not lower when the control handle is used, or lowers too slowly, the cable is too loose. Increase tension on the cable.

ADJUSTING THE CABLE TENSION

Follow the same procedure for each control handle.

1. Use a 11 mm wrench to loosen the jam nut (Figure 55).
2. While using the 11 mm wrench to prevent the jam nut from rotating, use an 8 mm wrench to rotate the cable nut (Figure 55) until the control handle functions properly. As you look at the top of the assembly (where the cable attaches to the assembly):
 - Rotate the cable nut counterclockwise to loosen or decrease the tension of the cable.
 - Rotate the cable nut clockwise to tighten or increase the tension of the cable.
3. Tighten the jam nut.

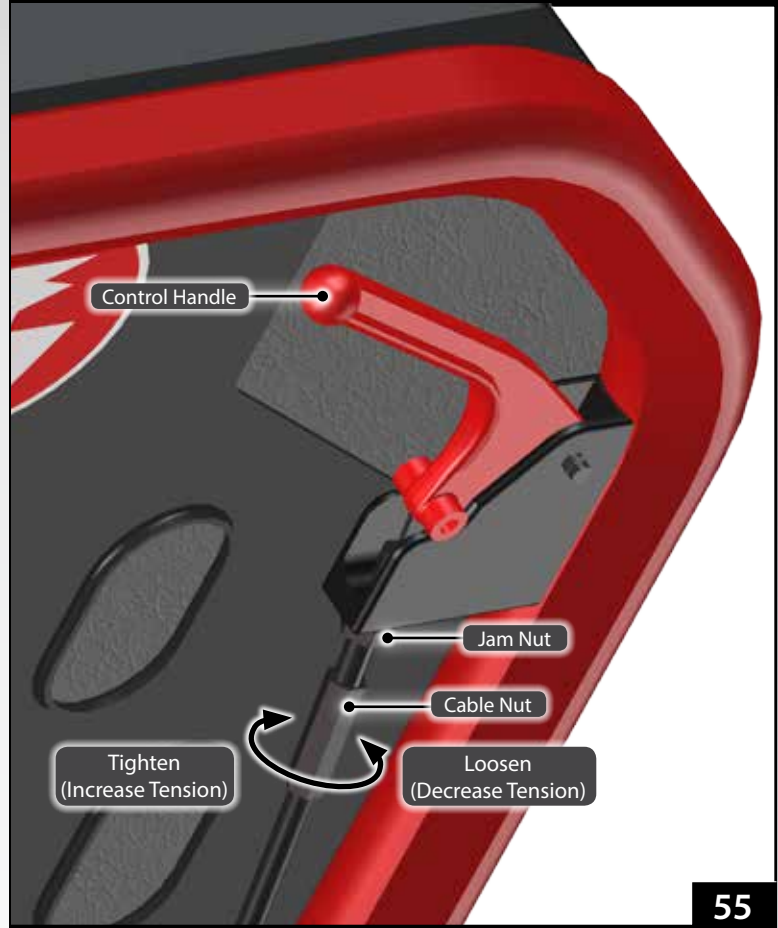

⚠ WARNING

Improper adjustment of the actuator-release handle cables can lead to injury. Adjust the tension of the cables when needed.

The iNjX can rapidly descend and cause injury if the actuator-release handles are activated while you are adjusting the cable tension. Use caution when adjusting cable tension.

Important

Improper cable tension can damage the iNjX. Adjust the cable for proper function as needed.

Use caution when adjusting the cable tension. Use a second person (minimum) for assistance.

Do not over-tighten the adjustment nut. Overtightening can damage the handle assembly. When you have finished adjusting the tension, snug the nut tight.

6.12 Adjusting Tension Of The Actuator Release Handles

The cable attached to the control-end and/or loading-end actuator-release handle may require occasional adjustment to retain proper function. If the handle activates too quickly or too slowly, adjust the tension on the cable.

Note: See "Figure 52" on page 44 for the location of the control-end and loading-end actuator-release handles.

KNOWING WHEN ADJUSTMENT IS NEEDED

- If the iNjX lowers without removing the actuator-release handle from its mount in the backrest or shock frame, the cable is too tight. Decrease tension on the cable.
- If the iNjX does not lower when the actuator-release handle is fully-compressed, or lowers too slowly, the cable is too loose. Increase tension on the cable.

ADJUSTING THE CABLE TENSION

Use caution when adjusting the cable tension. Use a second person (minimum) for assistance.

1. Locate the jam nut (Figure 56) and use a 9/16" or 14 mm open-end wrench to loosen the nut away from the handle.
2. After loosening the nut, **hold the cable steady**. (Use a wrench to hold the cable nut in place if needed.) Rotate the handle assembly around the cable (Figure 56). As you look at the top of the handle assembly (where the cable attaches to the assembly):
 - Rotate the handle assembly clockwise to loosen or decrease the tension of the cable.
 - Rotate the handle assembly counterclockwise to tighten or increase the tension of the cable.
3. Tighten the jam nut snug-tight. Do not overtighten.
4. Place approximately 150 pounds (68 kg) of weight (for example, use bags of sand) on the iNjX patient surface. Confirm that each actuator-release handle functions properly. Repeat Step 2 and Step 3 to adjust the tension of each cable until proper handle function is achieved.

If the cable cannot be adjusted satisfactorily, contact Ferno for repair. See "Parts and Service" on page 62.

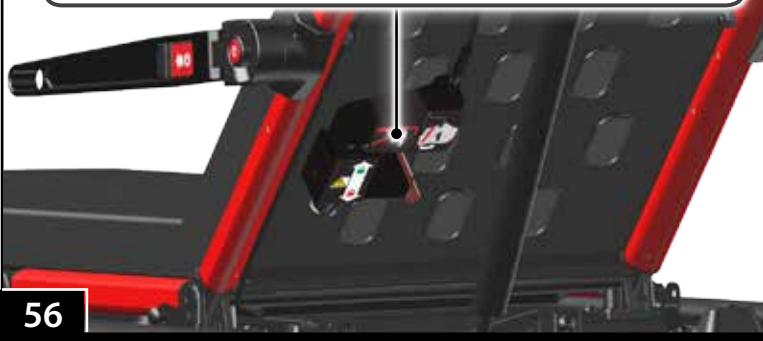
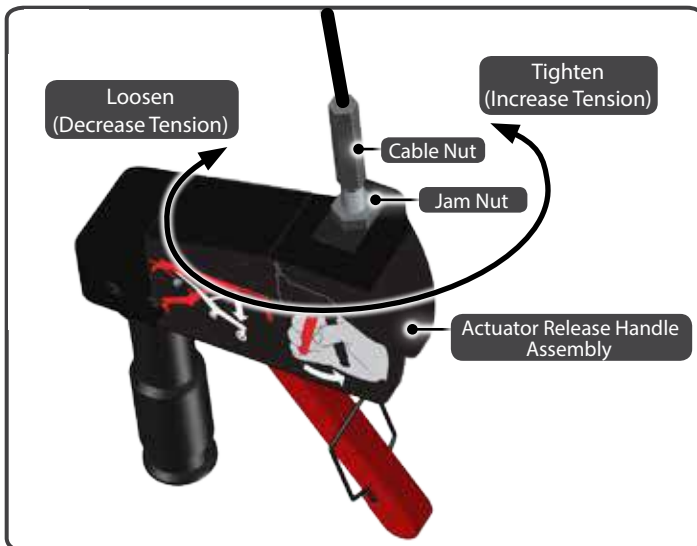

6.13 Storing the iNjX

1. Lower the iNjX to the fully-retracted position (Figure 57) and turn the power switch OFF.
2. Remove and charge the battery. See "Charging the Battery" on page 54 and "Storing the Battery" below.
3. Cover the battery cable connector on the iNjX with a bag. Seal the bag (for example, with a rubber band) to prevent moisture from entering the connector.

Before returning the iNjX to service:

1. Attach a fully-charged battery.
2. Turn the power switch ON.
3. Have your service's equipment maintenance personnel inspect the iNjX. See "Inspecting the iNjX" on page 48.

6.14 Charging the Battery

There are two ways to charge the battery: Secure the iNjX in the iNjLINE (equipped with the Integrated Charging System), or remove and connect the battery directly to a Ferno battery charger.

- **To charge the battery using the iNjLINE:** Verify the ambulance power to the iNjLINE ICS is ON and secure the iNjX in the iNjLINE. See "Integrated Charging System (ICS)" on page 21.
- **To charge the battery using the charger:** Remove the battery from the iNjX and connect it to a Ferno® battery charger. See "Battery" on page 20.

BATTERY CARE

- To store the battery if it will not be used for an extended period of time, see "Storing the Battery" below.
- The battery is water-resistant and is suitable for outdoor use. Do not submerge the battery in water.
- To clean the battery, wipe the battery port with a clean dry cloth if it becomes dirty or wet.
- Do not open the sealed battery case. Do not dismantle, open or shred the battery.
- Recycle the battery when it can no longer maintain a charge. Do not dispose of batteries with municipal waste. See "Recycling Notice" on page 55.
- Replace a damaged or cracked battery.

6.15 Storing the Battery

- Fully-charge the battery before storing it. Do not store the battery with less than a full charge.
- Store the battery only in a cool, dry place. Battery capacity can be affected if the battery is stored for long periods outside of the recommended temperature range.
- After an extended period of storage, charge the battery fully before use.



57

Tip

Deeply-Discharged Battery

If the battery is deeply discharged, the ICS may not be able to charge the battery. Connect the battery directly to the charger separate from the ambulance and ICS.

Charging Inside an Ambulance

To charge a battery inside an ambulance, the Ferno® ICS® must be used.

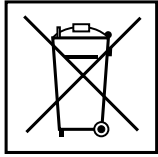

WEEE Directive

Do not dispose of batteries in municipal waste



iNjX 36 VDC

Lithium-iron phosphate battery (LiFePO₄)

Tip

Battery Recycling

In the U.S.A. and Canada, contact Call2Recycle toll-free for a nearby location to responsibly dispose of a Ferno rechargeable battery. See "Recycling Notice" on page 55.

Or, contact the government of your state, territory or country for recycling information. See "Recycling Notice" on page 55.

6.16 Recycling Notice

The iNjX uses a rechargeable, 36 Volt DC lithium-iron battery (specifically "LiFePO₄" as noted on the battery label).

Batteries: Recycle batteries when they can no longer hold a charge. Do not dispose of batteries with municipal waste. Contact the government in your state, territory or country for proper recycling.

Charger: Recycle the charger if it becomes damaged or fails to properly charge the battery. Do not dispose of the charger with municipal waste. Contact your government for proper recycling.

WEEE DIRECTIVE (EUROPEAN UNION)

European Union directive 2002/96/EC Waste Electrical and Electronic Equipment (WEEE) limits the disposal of electrical and electronic equipment in landfills. Contact the government in the country in which you reside for recycling information.

U.S.A. AND CANADA

"CALL2RECYCLE" 1.800.822.8837

Ferno is a partner with Call2Recycle Inc., a nonprofit corporation dedicated to helping consumers locate places to responsibly dispose of rechargeable batteries to meet all U.S. and Canadian requirements.

The iNjX 36 VDC lithium-iron phosphate battery is licensed with Call2Recycle. Contact **Call2Recycle** toll-free for a nearby location to send or drop off rechargeable batteries.

Note: *Call2Recycle does not accept the charger. Contact your local EPA to dispose of a damaged or nonfunctional charger.*

For further information:

- In the U.S.A., visit <http://www.call2recycle.org/>
- In Canada, visit <http://www.call2recycle.ca/>

6.17 Patient Restraints

The restraint system includes a pelvis strap, chest strap, harness, and two-piece leg restraint (Figure 58). The patient restraints are positioned both above and below the pad. To prepare the iNjX for use, follow the procedures in this section.

WARNING

An unrestrained patient can be injured. Use properly-installed patient restraints to secure the patient on the iNjX.

To attach patient restraints, refer to "Bracket-and-Post System" below and the instructions on the next page. Keep the patient restraints buckled when not in use.

1. To secure a patient on the iNjX, unbuckle the harness, pelvis, and leg restraints and position the straps out of the way.
2. Transfer the patient onto the iNjX following local protocols. Adjust the backrest, shock frame, and restraint length as needed.
3. Lay the shoulder straps on the patient's chest, with the links extended to the patient's waist.
4. Guide the pelvis-strap tang (metal buckle) through the links and fasten the buckle (Figure 58).
5. Adjust the pelvis strap and shoulder straps so they are snug on the patient.
6. Fasten the chest strap across the patient's ribcage (Figure 58).
7. Fasten the leg restraint over the patient's legs (Figure 58).

BRACKET-AND-POST SYSTEM

The pelvis strap and harness attach to the iNjX with a bracket-and-post system. To attach the straps:

1. Orient the bracket on the restraint strap with the bend facing the center of the iNjX and the tab up (Figure 59).
2. Slide the bracket over the post and pull the bracket upward to seat the post in the small end of the bracket.
3. Insert the retaining plug into the bracket (Figure 59).

Tip

Restraint Colors

When buckling the patient restraints, match the color-coded pieces:

- **Red-to-Red** (Harness Links connect to Pelvis Strap buckle)
- **Black-to-Black** (Harness Chest Strap and Leg Restraint buckles)

Buckle Orientation

Ferno recommends that you attach all patient restraints with the buckles at the same side for operator convenience and efficiency.



58

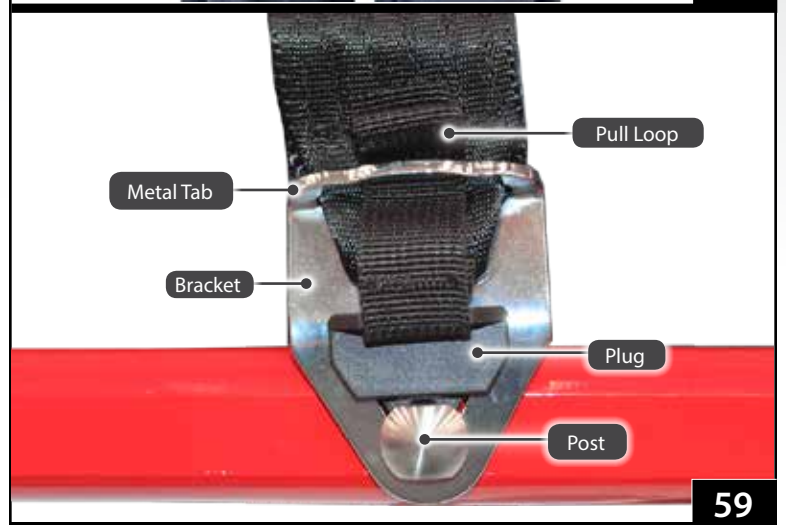

59

1 – ATTACH THE PELVIS STRAP

The pelvis straps have red webbing near the buckles (Figure 60). With the pad removed, attach each bracket of the Y-strap (two brackets per side) to the mounting posts at each side of the seat panel. Verify the brackets are seated on the posts and the strap is not twisted. Insert the retaining plugs.

2 – ATTACH THE CHEST/SHOULDER STRAPS

The chest straps have only black webbing and are connected to the shoulder straps, which have red webbing near the links (Figure 60). Attach the chest strap brackets to the mounting post at each side of the backrest. Verify the brackets are seated on the posts and the strap is not twisted. Insert the retaining plugs.

3 – ATTACH THE LEG RESTRAINT

Each strap of the leg restraint has a loop. Guide the loop through the restraint bracket on the iNjX, then insert the buckle (or tang) through the loop. Pull the strap to tighten the strap against the restraint bracket (Figure 60).

REMOVING PATIENT RESTRAINTS

Unbuckle the patient restraints.

To detach the pelvis and chest/shoulder straps, use the pull loop (Figure 59) to pull the retaining plugs out of the brackets, then press the brackets down toward the main frame to unseat the post from the bracket. Lift the bracket off the post. If the brackets are difficult to remove, stand on the opposite side of the iNjX and pull across the patient surface.

To remove the leg restraint, unbuckle the restraint and feed the buckle (or tang) through the loop. Then, remove the loop from the restraint bracket.

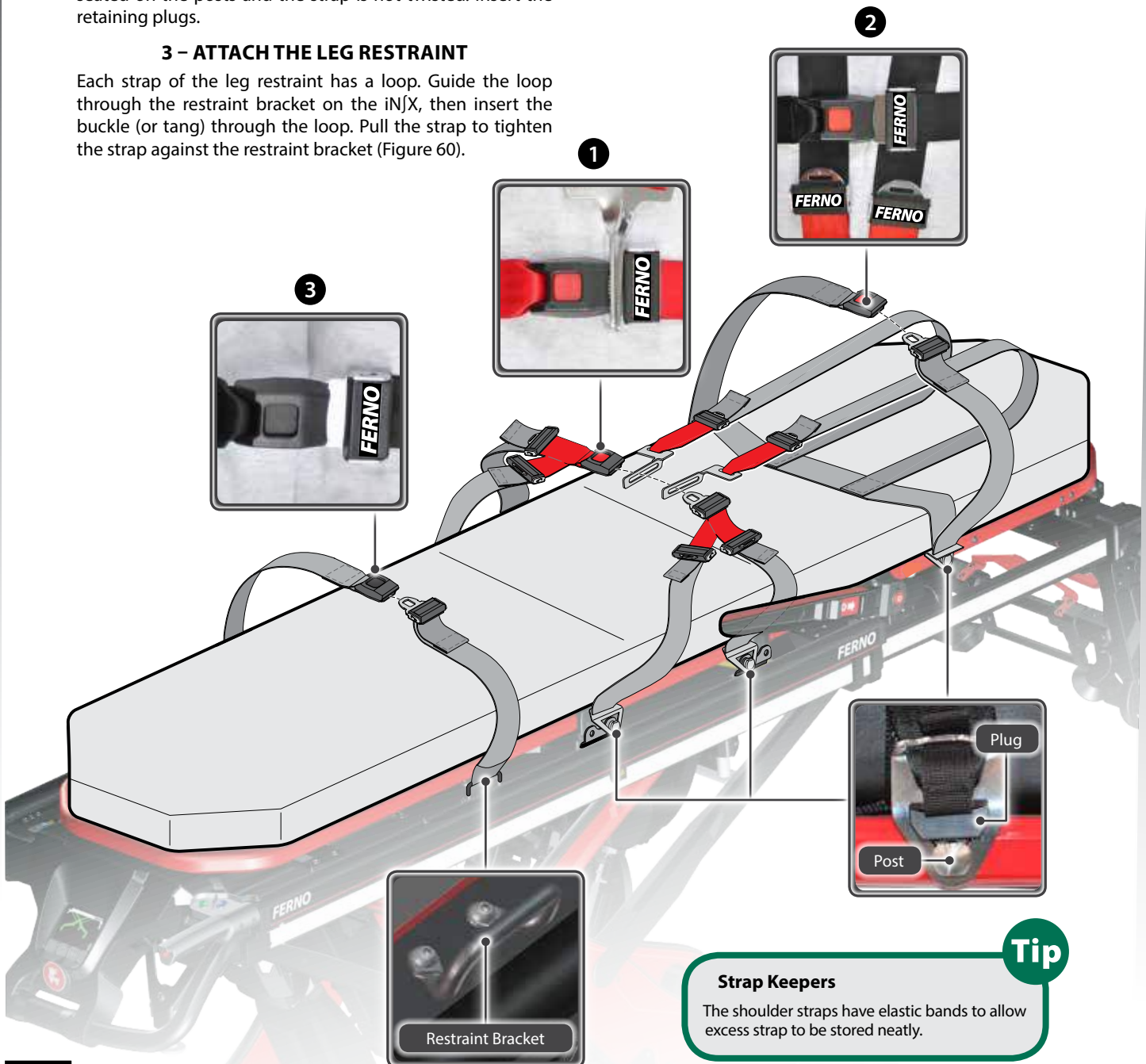

7 - INITIAL SETUP

7.1 Ambulance Information

The ambulance bumper extension must not exceed 13" (330 mm). The patient compartment must have a level floor large enough for the fully lowered iNjX, and an iNjLINE installed.

7.2 Accessories

Before placing the iNjX in service, assign appropriate personnel to install any accessories shipped with the iNjX. Keep accessory users' manuals with this manual for future reference. To order accessories, see "Accessories" on page 63. For additional free manuals, contact Ferno. See "Ferno Customer Relations" on page 2.

7.3 Charge and Install the Battery

Charge the battery using **only** the provided battery charger (Figure 61) or by securing the iNjX in the properly connected and powered iNjLINE. The charger is compatible with standard household electricity.

The charger is supplied with the proper cable and plug for your location. See "Battery Charger" on page 21 and "Charging the Battery" on page 54.

To install the battery, see "Attaching the Battery" on page 20.

WARNING

Attaching improper items to the iNjX can cause injury. Use only Ferno-approved items on the iNjX.

Important

Loose items and debris on the patient compartment floor can interfere with locking the iNjX into the iNjLINE. Keep the patient compartment floor clear.



61



62

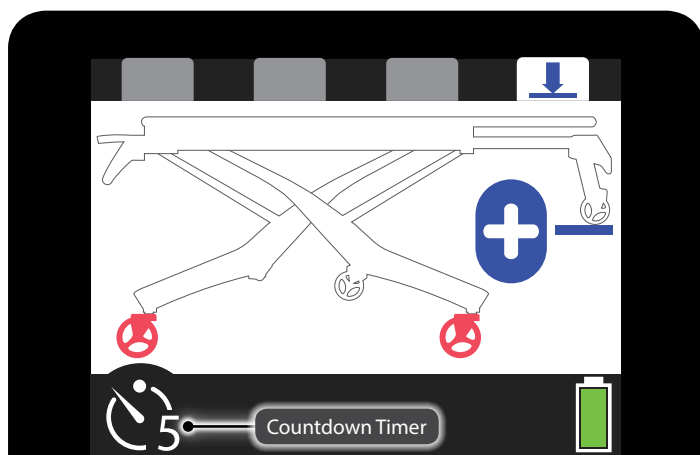

63

7.4 Set the Loading Height

The user can set the iNjX so it stops automatically at the proper loading height for the assigned ambulance. To set or change the loading height:

1. On a level surface, raise or lower the iNjX until the loading wheels roll directly onto the ambulance floor (Figure 62). Verify that the loading wheels are resting on the ambulance floor, the safety bar is caught by the safety hook, **and** that the loading-end legs have not lifted off the ground.
2. Press the Mode-Select button four times to enter the load-height set mode. See "Mode-Select Button" on page 23.
 - The background screen is white to indicate the load-height set mode (Figure 63). The wheels are red to indicate that the iNjX must not be rolled.
 - A blue line is displayed below the loading wheel, and a 15 second countdown timer is shown in the lower-left corner of the display.
 - The + symbol is displayed to indicate that pressing the button will set a new loading height.
3. Press and hold + before the timer expires. When pressed, a new, 5-second timer appears on the display. Continue holding + until the timer expires.
4. Turn the power switch OFF and then ON. See "Power Switch" on page 17.
5. Retract and extend the legs to verify the iNjX stops at the new loading height. Test loading and unloading the iNjX with the ambulance.

Error Setting Loading Height

No loading height will be set when the iNjX is at the factory-set **maximum transport height** or **maximum height**.

Tip

8 - TECHNICAL DATA

8.1 Charger Specifications

The Ferno 24/36VDC battery charger (Figure 64) is capable of charging the iN|X battery either directly or through the Integrated Charging System (ICS).

The battery charger is also capable of charging a 24 VDC Ferno® POWERFlex® POWERPac. See the battery charger users' manual for details.

| Charger Specification | Imperial | Metric |
|----------------------------|------------------------------------|--------------------------------------|
| Dimensions | 8.125 x 3.75 x 1.5 in | 206 x 95 x 38 mm |
| Charging Cable | 6 feet | 1.83 meter |
| Operating Temperature | -40°F to 113°F | -40 to 45°C |
| Storage Temperature | 32°F to 104°F | 0°C to 40°C |
| Weight | 1.7 lbs | 770 g |
| Input | AC 100~240V 50~60HZ, 92W | |
| Output | DC 39.6V 2A (LiFePO4 p/n 159-0093) | DC 29.3V 2A (Lead Acid p/n 082-2012) |
| iN X Battery Charging Time | 15 minutes* - 1 hour, 45 minutes | |
| POWERPac Charging Time | 1-2 hours | |

Note: *Minimum charging time is for one transport, with the battery charge maintained by ICS.

LEGAL NOTICE

The Ferno 24/36VDC battery charger is not compatible with, or designed to charge automobile batteries. However, the following notice is required by CE standards:

The battery terminal not connected to the chassis must be connected first. The second connection must be made to the chassis, remote from the battery and fuel line. The battery charger is then to be connected to the supply mains.

After charging, disconnect the battery charger from the supply mains. Then remove the chassis connection and then the battery connection.

8.2 iN|X Battery Specifications

The iN|X battery (Figure 65) is a rechargeable, 36-Volt DC battery. The input port is proprietary to Ferno and is compatible only with the Ferno battery charger.

| Specifications: Ferno iN X Battery | |
|---|---|
| Battery Type | 36 VDC, LiFePO ₄ (Lithium iron phosphate) |
| Number of internal cells | 11 |
| Storage Temperature | -40°F to 140°F (-40°C to 60°C) |
| Operating Temperature | -20°F to 140°F (-29°C to 60°C) |
| Battery Output | 36 VDC, 2.5 Amp Hours nominal |
| Charging Time (1 transport, charge maintained by ICS) | 15 minutes* minimum |
| Charging Time (depleted) | Up to 1 hour, 45 minutes |

Note: *Minimum charging time is for one transport, with the battery charge maintained by ICS.



64

WARNING

Charging an improper battery can cause injury and damage. Do not charge non-rechargeable batteries. The Ferno 24/36VDC battery charger is compatible only with the iN|X battery or Ferno POWERPac and ICS systems.

Charge lead-acid batteries only in a well-ventilated area (POWERPac batteries are lead-acid type).

The appliance (battery charger) is not intended for use by people (including children) with reduced physical, sensory or mental capabilities, or lack of experience and knowledge, unless they have been given supervision or instruction concerning use of the appliance by a person responsible for their safety.

Children should be supervised to ensure that they do not play with the appliance (battery charger).

If the supply cord is damaged, it must be replaced by a special cord or assembly available from Ferno or an authorized Ferno distributor or service center.



65

9 - TROUBLESHOOTING

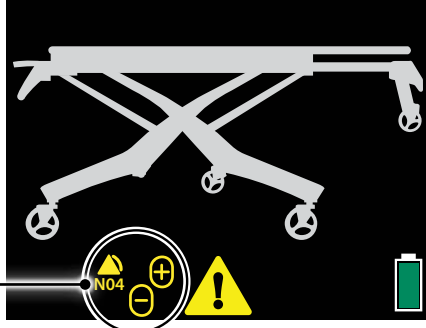

Status Indicator Display Location

9.1 Status Indicators

Status codes alert the operator to function or safety issues. The codes are grouped into four priority levels: no priority, low, medium, and high.

Status codes are color-coded. High-priority codes are red; all others are yellow. When a safety issue arises, a warning triangle is displayed next to the error code.

Refer to the chart below. Some codes indicate the need for service. See "Parts and Service" on page 62.

| Icon | Meaning | Solution |
|------|---|---|
| | A button has been pressed longer than the maximum time allowed. | Release the button. |
| | Auto-equalize problem. The iNjX is having trouble equalizing the legs. | If there is an obstruction in the legs, clear the obstruction. Use caution. The load on the iNjX may exceed the load capacity. Use additional help and provide lift-assistance. Use direct power. |
| | The battery is expecting to see charging power, but the iNjX is not detecting power at the ICS contacts. | Wait 30 seconds. If the error does not resolve itself in this time, there is a problem with the ICS. Report the problem to Ferno (page 2). |
| | Both buttons are being pressed at the same time. | Stop pressing the buttons. Press only or . If the situation continues, report the issue to Ferno (page 2). |
| | Improper charge voltage (voltage too high). | Verify the connections between the iNjX and the ICS; verify ICS connections to the ambulance power supply. The ICS or charger may be plugged into an outlet providing an incorrect power voltage. |
| | The battery is not charging. Charging power has been detected at the ICS contacts, but the battery is not detecting a charge. | Wait 30 seconds. If the error does not resolve itself in this time, this indicates a possible problem with the ICS, charger, iNjX, or battery. Report the problem to Ferno (page 2). |
| | Battery over-temperature. | Allow time for the battery to cool. Use non-powered operation to complete the transport. |
| | The actuator motor has overheated. The actuators are deactivated until the motor cools. | Allow time for the motors to cool. Use non-powered operation to complete the transport. |
| | A cable is routed from the controller to each actuator. One or both of these cables is disconnected. | Re-connect the cable(s). |
| | With weight on the iNjX, the legs are not moving at the proper speed, indicating: 1) Excessive weight on the iNjX; 2) Leg obstruction; 3) Mechanical problem. | 1) Remove weight from the iNjX or provide lift-assistance. 2) Clear the obstruction from the legs. Use caution. 3) Call Ferno for service (page 2). |
| | Without weight on the iNjX, the legs are not moving at the proper speed, indicating: 1) An obstruction in the legs; 2) A mechanical problem. | 1) Clear the obstruction from the legs. Use caution. 2) Call Ferno for service (page 2). |
| | Communication error. | Use direct power to complete the patient transport, and call Ferno for service (page 2). |
| | Patient-surface has been above the maximum safe transport height longer than 30 seconds; is disabled. The patient surface and warning triangle are red. The audible alarm sounds a pattern of 2+3 beeps. | Use to lower the iNjX to a safe transport height. |

10 - PARTS AND SERVICE

10.1 U.S.A. and Canada

In the United States and Canada, to order parts or for professional repair, contact EMSAR® – the only agent authorized by Ferno to manage, service, and repair Ferno products.

| | |
|-----------------------|-----------------|
| Telephone (Toll-Free) | 1.800.73.EMSAR |
| Telephone | 1.937.383.1052 |
| Fax | +1.937.383.1051 |
| Internet | www.EMSAR.com |

10.2 Worldwide

To order Ferno parts, and for professional repair, contact your Ferno distributor. Your distributor is the only agent authorized by Ferno to manage, service, and repair Ferno products.

10.3 Parts List

| Kit | Description | Qty |
|----------|--|-----|
| 203-0002 | Ferno battery 24/36VDC charger | 1 |
| 031-4113 | iNjX locking pad (mattress) | 1 |
| 037-4890 | 417-iNjX SAE-compliant harness restraint | 1 |
| 031-3892 | Restraint, 2 pc., 5' black | 1 |



WARNING

Modifying the iNjX can cause injury and damage. Use the iNjX only as designed by Ferno.

11 - ACCESSORIES

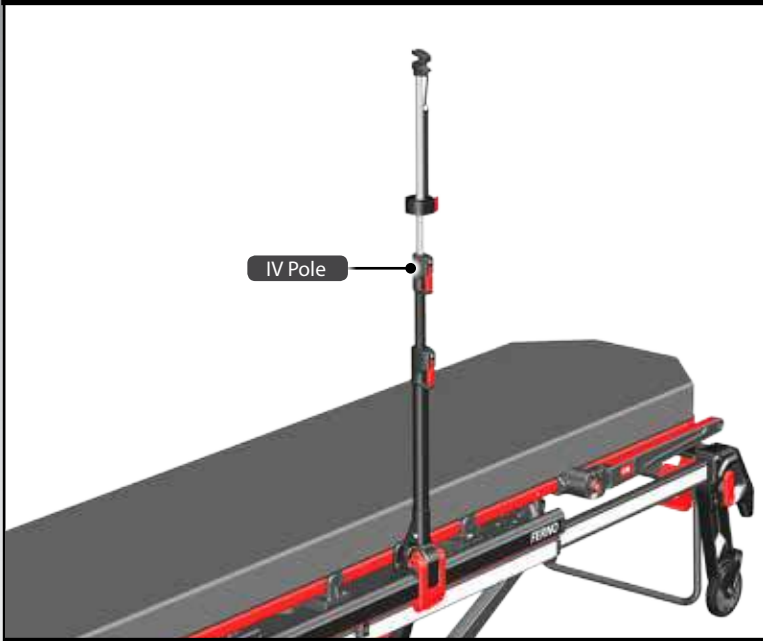

11.1 Accessories

A variety of accessories are compatible with the iNjX. For a complete list of accessories, contact Ferno.

Some accessories are designed to mount directly to the iNjX main frame.

Before placing the iNjX in service, assign appropriate personnel to install any accessories shipped with the iNjX. Keep accessory users' manuals with this manual for future reference. For additional, free manuals, contact Ferno. See "Ferno Customer Relations" on page 2.

ACCESSORY KITS

| Kit | Description | Qty |
|----------|---------------------------------------|-----|
| FWEPR | PacRac+ | 1 |
| LAIV3SCL | iNjX, Monobloc 3-stage IV pole | 1 |
| 082-2451 | iNjX Equipment holder, backrest panel | 1 |
| 082-2452 | iNjX Equipment holder, backrest frame | 1 |
| 082-2453 | iNjX Storage Net, telescoping frame | 1 |

WARNING

Attaching improper items to the iNjX can cause injury. Use only Ferno-approved items on the iNjX.

MAINTENANCE RECORD

| Date | Maintenance Performed | By |
|------|-----------------------|----|
| | | |
| | | |
| | | |
| | | |
| | | |
| | | |
| | | |
| | | |
| | | |
| | | |
| | | |
| | | |
| | | |
| | | |
| | | |
| | | |
| | | |
| | | |
| | | |
| | | |
| | | |
| | | |
| | | |
| | | |
| | | |
| | | |
| | | |
| | | |
| | | |
| | | |
| | | |
| | | |
| | | |
| | | |
| | | |
| | | |
| | | |
| | | |
| | | |
| | | |
| | | |

TRAINING RECORD

| Date | Printed Name | Signature | Training Method | | | Trainer Initials |
|------|--------------|-----------|-----------------|--------------|----------|---------------------|
| | | | Read Manual | Video/Online | Hands-On | |
| | | | | | | |
| | | | | | | |
| | | | | | | |
| | | | | | | |
| | | | | | | |
| | | | | | | |
| | | | | | | |
| | | | | | | |
| | | | | | | |
| | | | | | | |
| | | | | | | |
| | | | | | | |
| | | | | | | |
| | | | | | | |
| | | | | | | |
| | | | | | | |
| | | | | | | |
| | | | | | | |
| | | | | | | |
| | | | | | | |
| | | | | | | |
| | | | | | | |
| | | | | | | |
| | | | | | | |
| | | | | | | |
| | | | | | | |
| | | | | | | |
| | | | | | | |
| | | | | | | |
| | | | | | | |
| | | | | | | |

MAINTENANCE RECORD

| Date | Maintenance Performed | By |
|------|-----------------------|----|
| | | |
| | | |
| | | |
| | | |
| | | |
| | | |
| | | |
| | | |
| | | |
| | | |
| | | |
| | | |
| | | |
| | | |
| | | |
| | | |
| | | |
| | | |
| | | |
| | | |
| | | |
| | | |
| | | |
| | | |
| | | |
| | | |
| | | |
| | | |
| | | |
| | | |
| | | |
| | | |
| | | |
| | | |
| | | |
| | | |
| | | |
| | | |
| | | |
| | | |
| | | |
| | | |

